



PRO24





Amorebieta 01.02.2024

Estimados clientes, colaboradores y amigos,
Con este catálogo IZAR PROFESIONAL 2024 les presentamos la más amplia gama de referencias de nuestra historia.

En esta edición incluimos cerca de 10.000 artículos de los cuales queremos destacar varios nuevos productos:

En primer lugar, la broca multipropósito 1876 con punta de metal duro, afilado exclusivo IZAR y tratamiento superficial IZAR BLUE. Dicha broca es apta para trabajos en ladrillo refractario, cerámicas o porcelánicos blandos, metal, maderas duras, plásticos e incluso para el hormigón con percusión.

También resaltamos nuestra nueva broca de pared 1821 con cuatro cuchillas de metal duro en la punta y planos de arrastre en el mango para garantizar la máxima eficiencia en las condiciones más exigentes con taladro convencional.

Asimismo, les ofrecemos una gama de mango hexagonal para realizar trabajos con atornillador de impacto que incluye herramientas para el taladrado en metal, madera o construcción, roscado, avellanado y atornillado, siempre con los más altos estándares de calidad IZAR.

Hemos realizado un gran esfuerzo en desarrollar nuevas capacidades y ampliar nuestra propuesta técnica para dar con las soluciones de corte más apropiadas para un mercado cada vez más exigente. Esta apuesta por el valor añadido de nuestra gama y servicio ha sido nuevamente reconocida en los I Premios Cuadernos de Ferretería y Bricolaje celebrados en junio de 2023 en Madrid, donde fuimos galardonados con los premios a la calidad y a la innovación en la categoría de herramientas de corte a partir de la opinión de más de un millar de profesionales de la distribución.

Todo el equipo humano de IZAR nos sentimos orgullosos del trabajo realizado y confiamos en seguir dando respuesta a las necesidades de nuestros clientes de una manera sostenible y comprometida con el medio ambiente y con la excelencia en la calidad y el servicio.

Atentamente,

Dear customers, business partners and friends,

With this IZAR PROFESIONAL 2024 catalogue, we present you the widest range of references in our history.

In this edition, we include around 10,000 items, among which we would like to highlight several new products:

Firstly, our multipurpose 1876 drill bit, with a carbide tip, exclusive IZAR sharpening, and IZAR BLUE surface treatment. It is suitable for working on refractory brick, ceramics, soft porcelain, metal, hardwood, plastics, and even on concrete with percussion.

We also emphasize our new masonry 1821 drill bit with 4 carbide blades at the tip and a 3-flat shank, ensuring maximum efficiency in the most demanding conditions with a conventional drill.

Furthermore, we offer a complete range of hexagonal shank tools for work with impact drivers, which includes tools for drilling in metal, wood, or construction, threading, countersinking, and screwing, always meeting the highest IZAR quality standards.

We have made a significant effort to develop new capabilities and expand our technical offering to find the most suitable cutting solutions for an increasingly demanding market.

This commitment to the added value of our range and service has once again been recognized at the 1st Cuadernos de Ferretería y Bricolaje Awards (Hardware & DIY magazine awards), held in June 2023 in Madrid. We were honoured with the awards for quality and innovation in the cutting tools category, based on the opinions of over a thousand distribution professionals.

The entire IZAR team is proud of the work done and confident in continuing to meet the needs of our customers in a sustainable manner and committed to the environment, and to excellence in quality and service.

Sincerely,

Elena Serrano

General Manager

IZAR Cutting Tools SAL

✉ izar@izartool.com

Chers clients, collaborateurs et amis,

Avec ce catalogue IZAR PROFESIONNEL 2024, nous vous présentons la gamme la plus étendue de références de notre histoire.

Dans cette édition, nous avons inclus près de 10 000 articles, parmi lesquels nous souhaitons mettre en avant plusieurs nouveaux produits :

Tout d'abord, notre foret multifonction 1876, avec une pointe en carbure, un affûtage exclusif IZAR et un traitement de surface IZAR BLUE. Il convient pour travailler sur de la brique réfractaire, des céramiques ou de porcelaine tendre, du métal, du bois dur, des plastiques, même du béton avec percussion.

Nous mettons également en avant notre nouveau foret béton 1821 avec 4 lames en carbure à la pointe et des plans sur la queue, garantissant une efficacité maximale dans les conditions les plus exigeantes avec une perceuse conventionnelle.

De plus, nous vous proposons une gamme d'outils queue hexagonale, destinée aux travaux avec une visseuse Impact, qui comprend des outils pour percer le métal, le bois ou la construction, le taraudage, le fraisage et le vissage, toujours avec les normes de qualité les plus élevées d'IZAR.

Nous avons déployé d'énormes efforts pour développer de nouvelles capacités et élargir notre offre technique afin de trouver les solutions de coupe les plus appropriées pour un marché de plus en plus exigeant.

Cet engagement envers la valeur ajoutée de notre gamme et de notre service a été une nouvelle fois reconnu lors des I Prix Cuadernos de Ferretería y Bricolaje (magazine de quincaillerie et bricolage), tenus en juin 2023 à Madrid. Nous avons été honorés par deux prix dans les catégories qualité et innovation pour les outils coupants, basés sur l'opinion de plus d'un millier de professionnels de la distribution.

Toute l'équipe d'IZAR est fière du travail accompli, et nous sommes convaincus de continuer à répondre aux besoins de nos clients de manière durable et engagée envers l'environnement, tout en maintenant l'excellence en termes de qualité et de service.

Cordialement,



UNA EMPRESA CON VALORES

A Company With Values
Une entreprise avec des valeurs



Premio PYME del año 2021 en Bizkaia
SME of the year 2021 in Bizkaia award
Prix PME de l'année 2021 en Biscaye

Valores IZAR

- La honestidad
- El enfoque al cliente
- La adaptación al cambio
- El compromiso con la calidad y con el trabajo bien hecho
- El trabajo en equipo
- El interés por la tecnología y por la innovación

IZAR Values

- Honesty
- Customer focus
- Adaptation to change
- Commitment to quality and to the job well done
- Team-work
- Interest for technology and innovation

Valeurs IZAR

- L'honnêteté
- L'orientation client
- L'adaptation au changement
- L'engagement pour la qualité et pour le travail bien fait
- Le travail en équipe
- L'intérêt pour la technologie et l'innovation



UNA EMPRESA SOCIALMENTE RESPONSABLE

A socially responsible company
Une entreprise socialement responsable



COMPROMETIDOS CON LA FABRICACIÓN Y EL EMPLEO

Committed to manufacturing and jobs
Engagés dans la fabrication et l'emploi



LA CALIDAD TOTAL NOS DISTINGUE

Total quality makes the difference
La qualité totale nous différencie

ISO 90101:2015 · ISO 14001:2015 · VPA



PRESENCIA INTERNACIONAL

International Presence
Présence Internationale



Export Sales

Tel. (+34) 94 630 02 46
Fax. (+34) 94 630 02 37
✉ export@izartool.com

Ventes France

Tel. (+34) 94 630 02 45
Fax. (+34) 94 630 02 37
✉ france@izartool.com

1 Idoia Luengas
✉ iluengas@izartool.com

2 Maite Olariaga
✉ molariaga@izartool.com

3 Mikel Goyarrola
Export Manager
✉ mgoyarrola@izartool.com

4 Itziar Urrutxua
✉ iurrutxua@izartool.com

5 Xabier Asensio
Export Area Manager
✉ xasensio@izartool.com

6 Joseba Del Pozo
Chef Produit Technique
✉ jdelpozo@izartool.com

7 Aitziber Soutiño
✉ asoutino@izartool.com

EXPORTADORES A NIVEL MUNDIAL

A Major Figure in the global market
Présent sur tous les marchés mondiaux



Top Service
Opening Hours:
8.00 - 19.00

**Service 24h
en France**

Pour commandes de articles en stock
reçues avant 14.30h



- 1 Yolanda Barrena
Administrativa Comercial
- 2 Olaia Etxebarria
Administrativa Comercial
- 3 Leire Layana
Administrativa Comercial
- 4 Leticia González
Administrativa Comercial
- 5 Isabel Hernández
Administrativa Comercial
- 6 Iker Beobide
Product Manager Industrial
✉ ibeobide@izartool.com
- 7 Iñigo Markina
Promotor Técnico
✉ imarkina@izartool.com
- 8 Oiane Gortazar
Product Manager Professional
✉ ogortazar@izartool.com
- 9 Aitor Basauri
Técnico Comercial
✉ abasauri@izartool.com
- 10 Mónica González
Directora de Ventas Iberia
✉ mgonzalez@izartool.com

LÍDERES EN MERCADO NACIONAL

Domestic market leaders
Leader sur le marché national

Ventas Mercado Nacional

Tel. 94 630 02 41
Fax. 94 630 02 36
✉ comercial@izartool.com



Servicio 24h
Horario de Atención al Cliente:
8.00 - 19.00

ÍNDICE VISUAL

Visual Index
Index visuel

METAL

Ref.		Pág.	Ref.		Pág.
1032 New!	HSSE 5% Co  	19	1007	HSS  L30 mm 	75
	MULTI-PACK			UNI-PACK	
1022 New!	HSSE 5% Co  	20	1012	HSS  DIN 338 H 	76
	UNI-PACK				
1021	HSSE 5% Co  Multi INOX 	22	1025	HSS  DIN 338 N 	77
	MULTI-PACK			MULTI-PACK	
1004	HSSE 5% Co  Multi INOX 	25	1660	HSS   Max. 3 mm	78
	UNI-PACK			MULTI-PACK	
1016	HSSE 5% Co  DIN 338 N  Hard Mats. Duros	28	1052 New!	HSS + ZIRKONIO  DIN 1897 N 	80
	MULTI-PACK			MULTI-PACK	
1006	HSSE 5% Co  DIN 338 N  Hard Mats. Duros	32	1050	HSS  DIN 1897 N  Extra-Corta	81
	UNI-PACK			MULTI-PACK	
1020	HSSE 5% Co   INOX Stainless	37	1030	HSS  DIN 340 N  Larga Long	82
	MULTI-PACK			MULTI-PACK	
1005	HSSE 5% Co   INOX Stainless	40	1003	HSS  DIN 340 N  Larga Long	84
	UNI-PACK			UNI-PACK	
1027	HSSE 5% Co  L30 mm 	43	1040	HSS  DIN 1869 N  Extra Larga	86
	MULTI-PACK				
9015	Metal Duro 	44	1090	HSS  Laminada Rolled Laminé 	87
				MULTI-PACK	
9289	MD/HM Carbure 	44	1009	HSS  Laminada Rolled Laminé 	87
				UNI-PACK	
9100	Metal Duro 	46	1637 New!	C45 	88
1015	HSS + ZIRKONIO  DIN 338 N 	47	1110	HSS  DIN 345 N  Cónica Taper	89
	MULTI-PACK				
1065 New!	HSS + ZIRKONIO  DIN 338 N 	50	1802	  	92
	UNI-PACK				
1010	HSS + TIN  DIN 338 N  Uso General	53	1806	   Reversible	93
	MULTI-PACK				
1001	HSS + TIN  DIN 338 N  Uso General	58	1804	   Dcha. Right	93
	UNI-PACK				
1013	HSS + TIALSIN   Max. 5 mm	65	1803	   Dcha. Right	94
	MULTI-PACK				
1002	HSS   Max. 5 mm	69	1800 New!	 	94
	UNI-PACK				



ÍNDICE VISUAL

Visual Index
Index visuel

METAL

Ref.		Pág.	Ref.		Pág.
9994	<p>MÁQUINA AFILADORA BROCAS Drill Bit Sharpening Machine Machine affûteuse forets</p> 	99	4076	HSS-XT DOBLE WELDON 	116
1602	HSS  	100	4073 New!	Cono Holder Cône 	117
1612	HSS Espiral  	102	4074	DOBLE WELDON 	117
1607	HSSE 5% Co  	103	4067	TCT Serie Larga Long Length Série longue 	120
1617	HSSE 5% Co Espiral  	104	4060	HSS-XT Serie Corta Short Length Série courte 	121
1603	HSS  	105	4061	HSS-XT Serie Larga Long Length Série longue 	122
1609	HSSE 5% Co  	106	4062	HSS-XT S. Extra-Larga Extra-Long S. S. extra-longue 	123
1604	HSSE 5% Co Serie Corta Short Length Série courte 	107	1667	HSS  	124
1605	HSSE 8% Co S. Extra-Corta Stub Series S. extra-courte 	107	1663	INOX Stainless PVC Aluminio 	126
1606	HSS 	107	1665	INOX Stainless PVC Aluminio 	127
1610	HSS DIN 3126 	108	1636	HSS 	128
4078	TCT Serie Corta Short Length Série courte 	110	2010	HSS DIN 206 B ISO 236 	129
4077	TCT Serie Larga Long Length Série longue 	111	2575	HSSE 5% Co DIN 335 C 	130
4070	HSS-XT Serie Corta Short Length Série courte 	112	2530	HSS DIN 373 Allen 	131
4071	HSS-XT Serie Larga Long Length Série longue 	113	2572	HSSE 5% Co 	132
4072	HSS-XT S. Extra-Larga Extra-Long S. S. extra-longue 	114	3030	HSS DIN 352 Mano Hand Main   	133
4079	HSS-XT Serie Corta Short Length Série courte 	115			



ÍNDICE VISUAL

Visual Index
Index visuel

METAL







































Ref.				Pág.	Ref.				Pág.
3003	HSS	DIN 352	Mano Hand Main	134	3100	HSSE 5% Co	DIN 371	Máq.	153
3036	HSSE 5% Co	DIN 352 / 2181	INOX Stainless	136	3200	HSSE 5% Co	DIN 376/ 374	Máq.	154
3037	HSSE 5% Co	DIN 352 / 2181	INOX Stainless	137	3150	HSSE 5% Co	DIN 371	Máq.	155
3020	HSS	DIN 2181	Nº1 Nº3	138	3250	HSSE 5% Co	DIN 376/ 374	Máq.	156
3010	HSS	DIN 352 / 2181	Nº3	140	3119	HSSE 5% Co	ISO 529		157
3001	HSS	DIN 352	Nº3	143	3113	HSSE 5% Co	ISO 529		158
3023	HSS	DIN 352		144	3109	HSS	ISO 529		159
3040	HSS	ISO 529	Nº3	145	3157	HSS	ISO 529		161
3039	HSS	ISO 529	Tol. 6H	146	3103	HSS	ISO 529	Tol. 6H	163
3032	HSS	DIN 352	Whit-worth	149	3123	HSS	ISO 529	Tol. 6H	164
3012	HSS	DIN 352	Whit-worth	150	3500	M / MF	HSS	DIN 223	165
3026	HSS	DIN 5157	BSPP (Gas)	151	3005	HSS	DIN 223	Mano Hand Main	167
3016	HSS	DIN 5157	BSPP (Gas)	152	3536	HSSE 5% Co	DIN 22568	INOX Stainless	168
					3510	HSS	ISO 529		169
					3560	HSS	DIN 382	Tol. 6g	171
					3502	DIN 223	Whit-worth		172
					3546	HSSE 5% Co	DIN 24231	INOX Stainless	172



ÍNDICE VISUAL

Visual Index
Index visuel

METAL

Ref.				Pág.	Ref.				Pág.			
3506	BSPG (Gas)	HSS	DIN 24231		173	9230	MD HM Carbure	Tipo A Type			194	
3191	DIN 1814				174	9251	K20 + ALTIN	Tipo C Type	Radial Radial Hemisférique		195	
3912	"T" + Crique				174	9231	MD HM Carbure	Tipo C Type	Radial Radial Hemisférique		195	
3181	DIN 225				175	9252	MD/HM K20	Tipo N Type	Cono Invertido Inverted Cone Coupe en bout		196	
3184	ISO 529				175	9254	K20 + ALTIN	Tipo G Type	Ojiva Tree Ogive		196	
9016	MD HM Carbure	IZAR Std.				178	9255	MD/HM K20	Tipo M Type	Cónica Cone Conique		197
3409					179	9256	MD/HM K20	Tipo K Type	Cónica 90° 90° Cone Conique 90°		197	
3415	<p>ACEITES DE CORTE Y REFRIGERANTES Cutting Oils & Water Soluble Fluids Huiles de coupe et lubrifiants</p>  <p>UNI INOX ALU Universal Heavy Duty Non Ferrous</p> <p>STD TOP MULTI Standard Top Line Multiusos</p>				181	9257	MD/HM K20	Tipo E Type	Gota Oval Ovale		198	
3300	HSS	M / MF				187	9237	MD HM Carbure	Tipo E Type	Gota Oval Ovale		198
3305	HSS	M / MF				188	9258	K20 + ALTIN	Tipo D Type	Esférica Ball Sphérique		199
3303					189	9238	MD HM Carbure	Tipo D Type	Esférica Ball Sphérique		199	
3307					189	9266	MD/HM K20	Tipo H Type	Llama Flame Flamme		200	
9260	K20 + ALTIN	Tipo B Type			193	9267	MD/HM K20	Tipo L Type	Redondeada Ball Nosed Conique rayon		201	
9240	MD HM Carbure	Tipo B Type			193	9247	MD HM Carbure	Tipo L Type	Cónica Redon. Ball Nosed Cone Conique rayon		201	
9250	K20 + ALTIN	Tipo A Type			194	9268	K20 + ALTIN	Tipo F Type	Ojiva Redon. Ball Nosed Tree Ogive rayon		202	
9674	MD HM Carbure	IZAR Std.				206	9248	MD HM Carbure	Tipo F Type	Ojiva Redon. Ball Nosed Tree Ogive rayon		202
9459	MD HM Carbure	1Z				207	9674	MD HM Carbure	IZAR Std.			206
						207	9459	MD HM Carbure	Grabado Engraving Gravure		207	



ÍNDICE VISUAL

Visual Index
Index visuel

METAL











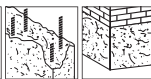
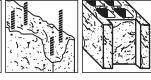





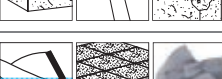

Ref.				Pág.	Ref.				Pág.		
9419	K10F + ALTiN	W	Aluminio		208	8950	DIN 263	ISO 11	Ranurado Int. Undercutting Rainurage int.		223
9411	K10F + ALTiN	W	Aluminio		208	8960	DIN 282	ISO 12	Roscado Ext. Ext. Threading Taraudage ext.		223
4412	HSS	W	Aluminio		209	8970	DIN 283	ISO 13	Roscado Int. Int. Threading Taraudage int.		224
4414	HSS	W	Aluminio		209	8990	HSSE 10% Co	DIN 4964B		225	
4223	HSSE 8% Co			211	8991	HSSE 10% Co	DIN 4964A		225		
4228	HSSE 8% Co	4% Cr		214	8992	HSSE 10% Co	DIN 4964E		226		
4229	HSSE 8% Co	4% Cr		216	8352					229	
1994	TPI 24				217	8350				230	
1999	Bimetal	TPI 18-24 32	INOX Stainless		217	8325	3-25 mm	1/8-1"		233	
1997	HSS	TPI 18-24 32	No Flexible		217	8330	3-30 mm	1/8-1" 1/8		233	
1996	CrV	TPI 24		217	8335	3-35 mm	1/8-1" 3/8		233		
8901	DIN 4971	ISO 1	Cilindrado 70° 70° Straight Cylindrage 70°		219	8341				233	
8900	DIN 4972	ISO 2	Escuadrado 45° 45° Bent Décolletage 45°		219	8326	26 mm	1"	Inox + Teflon		234
8904	DIN 4976	ISO 4	Ranurado Ext. Wide Face Square Rainurage ext.		220	8342	42 mm	1" 5/8	Inox + Teflon		235
8910	DIN 4980	ISO 6	Escuadrado 90° 90° Offset Side Décolletage 90°		220	8321				235	
8920	DIN 4981	ISO 7	Tronzado Parting Tronçonnage		221	8345				236	
8925	DIN 4973	ISO 8	Mandrinado Boring Straight Alésage		221						
8930	DIN 4974	ISO 9	Cilindrado int. Internal Sharped Cylindrage int.		222						
8940	DIN 4975	ISO 10	Cilindrado Recto Sharped Straight Cylindrage Droit		222						













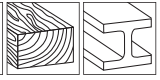













ÍNDICE VISUAL

Visual Index
Index visuel

CONSTRUCCIÓN Construction

Ref.		Pág.
1891	SDS plus 	238
1890	SDS plus 	242
1695	SDS plus 	247
1892	SDS max 	248
1894	SDS max 	250
1697	SDS max 	251
1875	SDS max 	253
1870	SDS plus 	255
1872	SDS max 	256
1871		258
1882		259
1879		261
1883		262
1877		263
1876 New!	 Ceramic 	264
1821 New!	MD/HM TCT 	267
1886	MD/HM TCT 	268
1846	MD/HM TCT 	269

















Ref.		Pág.
1880	MD/HM TCT 	272
1836	MD/HM  Ceramic	276
1645	HSSE 8% Co 	277
1647	 Ceramic 	280
1661	 Ceramic 	282
1662	 Ceramic 	283
1860		286
1851		288
1852		288
1858		289
1854		289
1853		290
1855		290
1861		290
1857		290
1864		290
1862		290
1863		293
1849		293
8309	9 mm 	294
8318 New!	18 mm 	294
8319 New!	19 mm 	295

















ÍNDICE VISUAL

Visual Index
Index visuel

MADERA Wood Bois

Ref.		Pág.
1641	HSS 	298
1640	CrV 	300
1651	Heavy Duty  1/4" E6.3	304
1650	 1/4" E6.3	306
1655	CrV 	308
1644	SDS plus 	310
1643		311
1692 New!	SDS plus 	312
1639	HSS 	313
1685	MD HM Carbure 	314
1669	MD HM Carbure 	314
1679	MD HM Carbure 	314
1678	MD HM Carbure 	315
1674	MD HM Carbure 	315
1676	MD HM Carbure 	315
1677	MD HM Carbure 	316
1670	MD HM Carbure 	316

Ref.		Pág.
1671	MD HM Carbure 	316
1672	MD HM Carbure 	317
1673	MD HM Carbure 	317
1681	MD HM Carbure 	317
1682	MD HM Carbure 	318
1686	MD HM Carbure 	318
1615	Diente MD 	320
1620	C60 	321
1625		322
1689	MD HM Carbure EVA 	323
7009	MD HM Carbure  Ceramic	324
7002	HSS  Pladur Escayola	324
7003	HSS  Auto center	325
7001	HSS 	325
1690	MD HM Carbure 	326



Atornilladores de Impacto

Impact Drivers

Visseuses impact

Colores por tipo de material
Color chart for materials
Couleurs par type de matériau

METAL

CONSTRUCTION

MADERA
WOOD
BOIS

OTROS
OTHERS
AUTRES



Testado en condiciones extremas
Tested under extreme conditions
Testé dans des conditions extrêmes

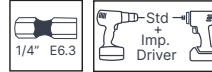

Ref.		Pág.
1616	 HSSE 5% Co Materiales duros Hard Materials Matériaux durs	329
1613	 HSS Usos general General Purpose Utilisation générale	330
1611	 HSS	331
1622	 HSSE 5% Co	333
3610	 HSSE 5% Co	334
3650	 HSSE 5% Co	335
1614	 HSS	336
1635	 HSSE 5% Co 5 Z	337
8352		338
1839	 Porcelain	340
1834	 MD/HM TCT Vidrio y porcelana blanda Glass and Soft Tiles Verre et porcelaine tendré	342
1601	 MD/HM TCT	343

Ref.		Pág.
1654	 Heavy Duty 3 Z	345
1651	 Heavy Duty	346
1650		348
1621	 CrV	349
1523	 S2	352
1524	 Standard	353
1529	 Adaptadores hexagonales Hex shank Adaptors Adaptateurs hexagonaux	354
1527		355
3407	 Extractores impacto Impact Extractors Extracteurs impact	356















ÍNDICE VISUAL

















Visual Index
Index visuel

SIERRAS

Saw Blades

Lames scies





Ref.			Pag.
2940	 		361
2910	 		365
2930	 Especial		370
2950	 Especial		378
1950	Sable 		382
1920	Sable 		385



Ref.			Pag.
1960	Sable Especial		390
1940	Calar  Inserción "T" 		398
1910	Calar  Inserción "T" 		407
1930	Calar  Inserción "T"  Especial		412
1945	Calar  Inserción "U" 		413
1915	Calar  Inserción "U" 		415

PUNTAS ATORNILLAR

Screwdriver Bits

Embouts vissage

			Pag.
1520	Std.		418
1521	Torsión		422
1523 New!	S2 material	 	423
1524 New!	Std.		424

		Pag.
1527		425
1529	 New! Adaptadores hexagonales Hex shank Adaptors Adaptateurs hexagonaux	426
3407	 Extractores impacto Impact Extractors Extracteurs impact	427

PRESENTACIONES

Presentations

Presentations



PRESENTACIÓN IZAR EN LÍNEA
IZAR Line Presentation
Presentation IZAR ligne

Pag. 430



PRESENTACIÓN IZAR EN CASCADA
IZAR Cascade Presentation
Presentation IZAR cascade

Pag. 436



EXPOSITORES APILABLES
Stacking Exhibitors
Présentoirs apilables

Pag. 440



01.



METAL

Metal 17
Métal 17

BROCAS

Drill Bits 18
Forets 18

PORTA-BROCAS Y ACCESORIOS

Drill Chucks & Accessories 92
Mandrins et accessoires 92

BROCAS ESPECIALES

Special Drill Bits 100
Forets spéciaux 100

FRESAS HUECAS M. ELECTROMAGNÉTICAS

Annular Cutter Core Drills 110
Fraises à carotter UP électromagnétiques 110

CORONAS

Hole Saws 124
Trépan 124

ESCARIADORES

Reamers 129
Alésoirs 129

AVELLANADORES

Countersinks / Counterbores 130
Outils 130

MACHOS Y COJINETES

Taps & Dies 133
Tarauds et filières 133

ACEITE / LUBRICANTE CORTE

Cutting Oil / Coolant 180
Huile / Lubrifiant de coupe 180

REPARADORES ROSCAS

Thread Repairs 186
Filets rapportes 186

FRESAS ROTATIVAS, FRESAS FRONTALES

Rotary Burrs, End Mills 192
Fraises limes rotativas, Fraises 192

HOJAS DE SIERRAS DE CINTA

Band Saw Blades 210
Lames de scie à ruban 210

HERRAMIENTAS TORNEADO

Brazed Turning Tools 218
Outils de tour 218

02.



CONSTRUCCIÓN

Construction 237
Construction 237

HERRAMIENTAS SDS PLUS

SDS plus Tools 238
Outils SDS plus 238

HERRAMIENTAS SDS MAX

SDS max Tools 248
Outils SDS max 248

ADAPTADOR iCONNECT

iConnect Adaptor 252
Adaptateur iConnect 252

CINCELES

Chisels 254
Burins 254

BROCAS MANGO CILÍNDRICO

Straight Shank Drill Bits 259
Forets queue cylindrique 259

CORONAS

Hole Saws 277
Trépan 277

DISCOS DIAMANTE

Diamond Cutting Blades 287
Disques diamant 287



04. HEX

ATORNILLADORES DE IMPACTO Impact Drivers Visseuses impact	327
METAL Metal Métal	328
CONSTRUCCIÓN Construction Construction	340
MADERA Wood Bois	345
OTROS Others Autres	352

06.

PUNTAS ATORNILLAR Screwdriver Bits Embouts vissage	417
---	-----

03.



MADERA Wood Bois	297
BROCAS Drill Bits Forets	298
FRESAS Router Cutters Fraises	314

05.



SIERRAS Saw Blades Lames scies	357
OSCILANTES MULTI-FUNCIÓN Oscillating Multi-Tools Outils multifonction	358
SIERRAS SABLE Sabre Saw Blades Lames scie sabre	380
SIERRAS CALAR Jig Saw Blades Lames scies sauteuses	396

07.



PRESENTACIONES Presentations Presentations	429
PRESENTACIÓN IZAR EN LÍNEA IZAR Line Presentation Presentation IZAR ligne	430
PRESENTACIÓN IZAR EN CASCADA IZAR Cascade Presentation Presentation IZAR cascade	436
EXPOSITORES APILABLES Stacking Exhibitors Présentoirs apilables	440
CONDICIONES GENERALES VENTA General Selling Conditions Conditions generales de vente	442
ÍNDICE SÍMBOLOS Symbol Index Index de symboles	444
BÚSQUEDA POR REFERENCIA (Ref. - Pag) Search by reference (Ref. - Page) Recherche par référence (Ref. - Page)	446



METAL

Metal

Métal



BROCAS

Drill Bits

Forets

18

PORTABROCAS Y ACCESORIOS

Drill Chucks & Accessories

Mandrins et accessoires

92

BROCAS ESPECIALES

Special Drill Bits

Forets spéciaux

100

FRESAS HUECAS M.

ELECTROMAGNÉTICAS

Annular Cutter Core Drills

Fraises à carotter UP électromagnétiques

110

CORONAS

Hole Saws

Trépan

124

ESCARIADORES

Reamers

Alésoirs

129

AVELLANADORES

Countersinks / Counterbores

Outils

130

MACHOS Y COJINETES

Taps & Dies

Tarauts et filières

133

ACEITE / LUBRICANTE CORTE

Cutting Oil / Coolant

Huile / Lubrifiant de coupe

180

REPARADORES ROSCAS

Thread Repairs

Filets rapportes

186

FRESAS ROTATIVAS, FRESAS FRONTALES

Rotary Burrs, End Mills

Fraises limes rotatives, fraises

192

HOJAS DE SIERRAS DE CINTA

Band Saw Blades

Lames de scie à ruban

210

HERRAMIENTAS TORNEADO

Brazed Turning Tools

Outils de tour

218



METALMAX

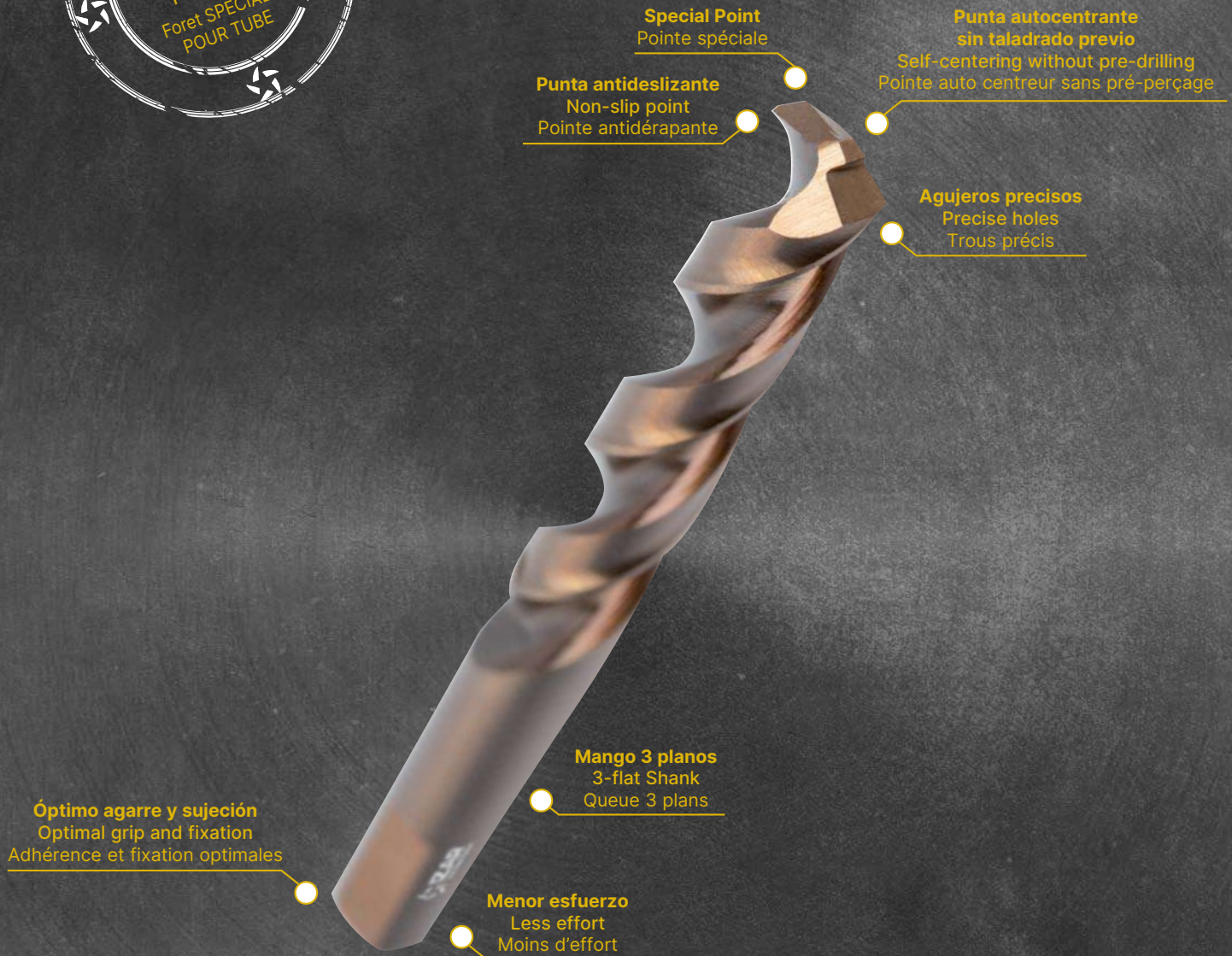

TUBO
Tube
Tube

CHAPA
Sheet
Tôle

INOX
Stainless Steel
Inox

COBRE
Copper
Cuivre

ALUMINIO
Aluminum
Aluminium



BROCAS

Drill Bits

Forets

Ref. **1032**

BROCA MANGO CILINDRICO METALMAX. SERIE CORTA

METALMAX Cobalt Drill Bit. Jobber Series

Foret cobalt METALMAX. Série courte

New!



HSSE 5%Co	DIN 338 W					Ambar Gold Finish Finition Or	Rectificado Ground Taillé meulé	Tol. D h8
------------------	-----------	--	--	--	--	--	--	-----------

INOX Stainless Steel Acier INOX	Cobre Copper Cuivre	Aluminio Aluminium	Tubo Tube Tube	Chapa Sheet Tôle
--	----------------------------------	------------------------------	-----------------------------	-------------------------------

D mm	L mm	I mm		N° Art.	€
1,00	34	12	10	44820	
1,50	40	18	10	44822	
2,00	49	24	10	15169	
2,50	57	30	10	44823	
3,00	61	33	10	15191	
3,30	65	36	10	84181	
3,50	70	39	10	15193	
4,00	75	43	10	15215	
4,20	75	43	10	15238	
4,50	80	47	10	15243	
5,00	86	52	10	15244	
5,50	93	57	10	15247	
6,00	93	57	10	15265	
6,50	101	63	10	15270	
6,80	109	69	10	84182	

D mm	L mm	I mm		N° Art.	€
7,00	109	69	10	15273	
7,50	109	69	10	15280	
8,00	117	75	10	15282	
8,50	117	75	5	15283	
9,00	125	81	5	15285	
9,50	125	81	5	44825	
10,00	133	87	5	15291	
10,20	133	87	5	84183	
10,50	133	87	5	15292	
11,00	142	94	5	15298	
11,50	142	94	5	44828	
12,00	151	101	5	15303	
12,50	151	101	5	44831	
13,00	151	101	5	15304	



Expo - Ref. 1032



220 Pcs

∅	1	1,5	2	2,5	3	3,5	4	4,5
Pcs	10	10	10	10	10	10	10	10
∅	5	5,5	6	6,5	7			
Pcs	10	10	10	10	10			
∅	7,5	8	8,5	9				
Pcs	10	10	10	10				
∅	9,5	10	10,5	11				
Pcs	10	10	5	5				
∅	11,5	12	12,5	13				
Pcs	5	5	5	5				

N° Art. 41034: €



Ref. **1022**

BROCA COBALTO METALMAX

METALMAX Cobalt Drill Bit
Foret cobalt METALMAX

New!



HSSE 5%Co	DIN 338 W						Ambar Gold Finish Finition Or	Rectificado Ground Taillé meulé	Tol. D h8
INOX Stainless Steel Acier INOX	Cobre Copper Cuivre	Aluminio Aluminium	Tubo Tube Tube	Chapa Sheet Tôle					

D mm	L mm	I mm		N° Art.	€		D mm	L mm	I mm		N° Art.	€
1,00	34	12	2	44618		*	6,80	109	69	1	84169	
1,50	40	18	2	44627		*	7,00	109	69	1	80127	
2,00	49	24	2	80135		*	7,50	109	69	1	81854	
2,50	57	30	2	44633		*	8,00	117	75	1	80116	
3,00	61	33	2	80125		*	8,50	117	75	1	81855	
3,30	65	36	2	84168		*	9,00	125	81	1	80131	
3,50	70	39	2	81844		*	9,50	125	81	1	44636	
4,00	75	43	2	80113		*	10,00	133	87	1	80117	
4,20	75	43	1	81845			10,20	133	87	1	84170	
4,50	80	47	1	81846			10,50	133	87	1	81856	
5,00	86	52	1	80114			11,00	142	94	1	81857	
5,50	93	57	1	81847			11,50	142	94	1	44642	
6,00	93	57	1	80115			12,00	151	101	1	81858	
6,50	101	63	1	81848			12,50	151	101	1	44645	
							13,00	151	101	1	81859	

* € = 2uds



Display 73 - Ref. 1022

New!



∅	8	8,5	9	10	10,5	11	12	13
Pcs	5	5	3	3	2	2	2	2
∅	5	5	5,5	6	6	6,5	7	7,5
Pcs	3	2	5	3	2	5	5	5
∅	1,5	2	2,5	3	3,5	4	4	4,5
Pcs	3	3	3	5	5	3	2	5

Ref. 4995 - N° Art. 13781: €



New!



Set **1462**

6 Pcs

Cont. Ø	Nº Art.	€
2 - 3 - 4 - 5 - 6 - 8 mm	80138	

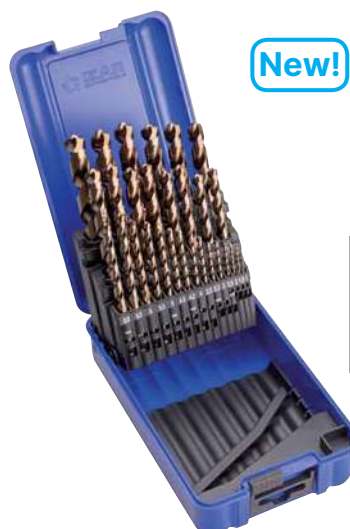

New!

Set **1459**

29 Pcs

Cont. Ø	Nº Art.	€
1 - 13 x 0,5 mm *	84159	

* + Previos Roscado / Before Threading
Pré-Tarudage (3,3 - 4,2 - 6,8 - 10,2 mm)



Set **1466**

19 Pcs

Cont. Ø	Nº Art.	€
1 - 10 x 0,5 mm	80139	



Set **1456**

25 Pcs

Cont. Ø	Nº Art.	€
1 - 13 x 0,5 mm	34348	

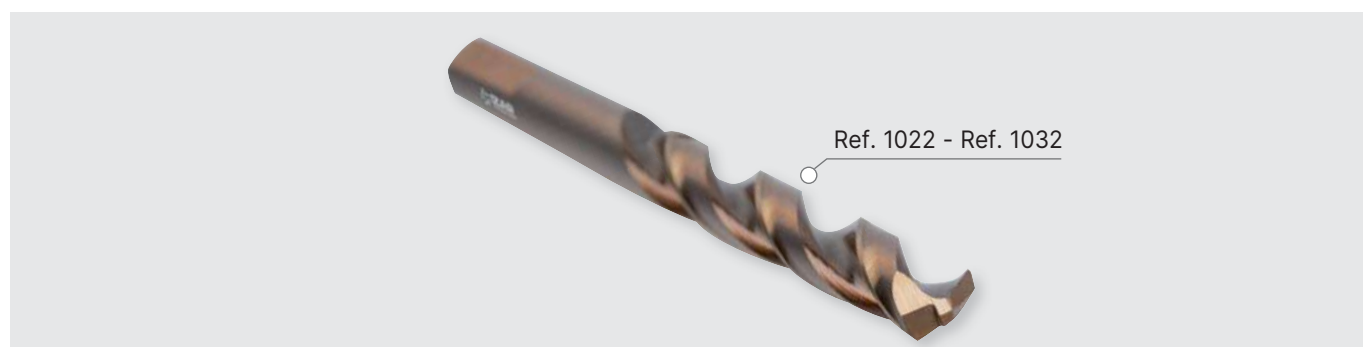

Ref. 1022 - Ref. 1032

Ref. **1021**

BROCA UNIVERSAL COBALTO MULTI INOX

Multi-STAINLESS Cobalt Universal Drill Bit
Foret universel cobalt Multi INOX



BOROA

HSSE 5% Co	DIN 338 W						 Chapa Sheets Tôle
----------------------	--------------	--	--	--	--	--	-----------------------------



Video



Aceros <850 N/mm ² Steel / Aciers	INOX Stainless Steel Acier INOX	Cobre Copper Cuivre	Aluminio Aluminium
---	--	----------------------------------	------------------------------

Ángulo de Punta 135°:

- Especial taladro mano.
- Aguzado de gran precisión.
- Menor fuerza de corte.
- Buen centrado superficies curvas.

Hélice 40°:

- Excelente evacuación de viruta.
- Taladrado más rápido y estable.
- Agujeros precisos hasta el final.

Mango de 3 Planos:

- Óptimo agarre y sujeción.
- Menor esfuerzo.
- Evita que se resbale la broca.
- Inmejorable transmisión de la energía.

135° Point Angle:

- Special portable drilling machine.
- High precision Split Point.
- Lower cutting-forces.
- Good centering on concave surfaces.

40° Helix:

- Excellent chip removal.
- Faster & stable drilling.
- Accurate holes right to the end.

3-Flat Shank:

- Optimum fixing.
- Low effort.
- No spinning in the drill-chuck.
- Ideal energy-transmission.

Angle de pointe 135°:

- Perceuses à main
- Affûtage précision
- Force de coupe inférieure
- Autocentrage surfaces courbes

Helix 40°:

- Excellente évacuation copeaux
- Perçage plus rapide et stable
- Trous précis jusqu'au bout

Queue 3 plans:

- Fixation optimale
- Effort inférieur
- Pas de glissement du foret
- Transmission d'énergie parfait

D mm	L mm	I mm		Nº Art.	€
1,00	34	12	10	25641	
1,25	38	16	10	25642	
1,50	40	18	10	25644	
1,75	46	22	10	69953	
2,00	49	24	10	25645	
2,25	53	27	10	25646	
2,50	57	30	10	25647	
2,75	61	33	10	25648	
3,00	61	33	10	25650	
3,20	65	36	10	25710	
3,25	65	36	10	25728	
3,30	65	36	10	25730	
3,50	70	39	10	25733	
3,75	70	39	10	25738	
4,00	75	43	10	25744	
4,20	75	43	10	25751	
4,25	75	43	10	25756	
4,50	80	47	10	25762	
4,75	80	47	10	25764	
5,00	86	52	10	25769	
5,20	86	52	10	25774	

D mm	L mm	I mm		Nº Art.	€
5,25	86	52	10	25777	
5,50	93	57	10	25780	
5,75	93	57	10	25786	
6,00	93	57	10	25788	
6,25	101	63	10	25790	
6,50	101	63	10	25793	
6,75	109	69	10	25795	
6,80	109	69	10	25798	
7,00	109	69	10	25801	
7,25	109	69	10	25803	
7,50	109	69	10	25805	
7,75	117	75	10	69952	
8,00	117	75	10	25807	
8,25	117	75	5	25809	
8,50	117	75	5	25811	
8,75	125	81	5	69950	
9,00	125	81	5	25813	
New! 9,10	125	81	5	48842	
New! 9,20	125	81	5	48845	
9,25	125	81	5	69949	
New! 9,30	125	81	5	48848	

D mm	L mm	I mm		Nº Art.	€
9,50	125	81	5	25815	
9,75	133	87	5	69947	
10,00	133	87	5	25817	
10,20	133	87	1	32666	
10,25	133	87	1	25819	
10,50	133	87	1	25821	
10,75	142	94	1	69946	
11,00	142	94	1	25823	
New! 11,10	142	94	1	48851	
New! 11,20	142	94	1	48854	
11,25	142	94	1	69945	
New! 11,30	142	94	1	48857	
11,50	142	94	1	25825	
11,75	142	94	1	69944	
12,00	151	101	1	25827	
12,25	151	101	1	69943	
12,50	151	101	1	25829	
12,75	151	101	1	69941	
13,00	151	101	1	25831	
14,00	160	108	1	81564	

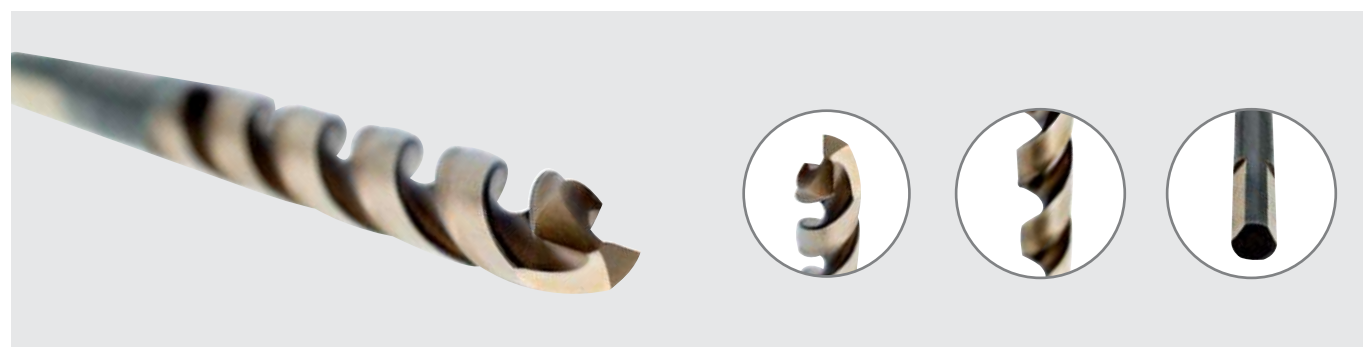

Expo - Ref. 1021



Cuartos / Quarters / Quarts

∅	1	1,5	2	2,5	3	3,25
Pcs	10	10	10	10	10	10
∅	3,5	4	4,25	4,5	5	
Pcs	10	10	10	10	10	
∅	5,5	6		6,5	7	
Pcs	10	10		10	10	
∅	7,5	8		8,5	9	
Pcs	10	10		10	10	
∅	9,5	10	11	12	13	
Pcs	5	5	2	2	2	

N° Art. 57527: €

Previos Roscado / Before Threading / Pré-Tarudage

∅	1	1,5	2	2,5	3	3,3
Pcs	10	10	10	10	10	10
∅	3,5	4	4,2	4,5	5	
Pcs	10	10	10	10	10	
∅	5,5	6		6,5	6,8	
Pcs	10	10		10	10	
∅	7	7,5		8	8,5	
Pcs	10	10		10	10	
∅	9	9,5	10	10,2	11	12
Pcs	10	5	5	2	2	2

N° Art. 57981: €

Línea 1 m - Ref. 1021



Cuartos / Quarters / Quarts

1,5 10	3	4	5	6	7	8	9	10	12	mm pcs
	10	10	10							
1 10	2,5	3,5	4,5	5,5	6,5	7,5	8,5	9,5	11	13
	10	10	10							

N° Art. 71647: €

Previos Roscado / Before Threading / Pré-Tarudage

1,5 10	3	4	5	6	7	8	9,5	10,2	12	mm pcs
	10	10	10				5			
1 10	2,5	3,5	4,5	5,5	6,8	7,5	9	10	11	13
	10	10	10				10			

N° Art. 71648: €





Expo - Ref. 1021



176 Pcs

∅	1	1,5	2	2,5	3	3,5	4	4,5
Pcs	10	10	10	10	10	10	10	10
∅	5	5,5	6	6,5	7			
Pcs	10	10	10	10	10			
∅	7,5	8	8,5	9				
Pcs	10	10	5	5				
∅	9,5	10	10,5	11				
Pcs	5	5	1	1				
∅	11,5	12	12,5	13				
Pcs	1	1	1	1				

N° Art. 55448: €





Ref. **1004**

BROCA UNIVERSAL COBALTO MULTI INOX

Multi-STAINLESS Cobalt Universal Drill Bit

Foret universel cobalt Multi INOX



BOROA

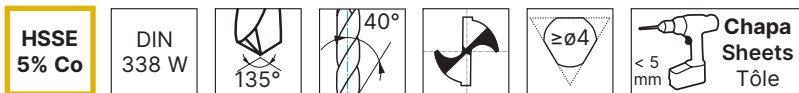

D mm	L mm	I mm		Nº Art.	€
1,00	34	12	2	55605	*
1,50	40	18	2	55606	*
2,00	49	24	2	34051	*
2,50	57	30	2	34052	*
3,00	61	33	2	34053	*
3,25	65	36	2	34054	*
3,30	65	36	2	39917	*
3,50	70	39	2	34055	*
4,00	75	43	2	34056	*
4,20	75	43	1	39918	
4,25	75	43	1	34057	
4,50	80	47	1	34058	
5,00	86	52	1	34059	
5,50	93	57	1	34060	
6,00	93	57	1	34061	

D mm	L mm	I mm		Nº Art.	€
6,50	101	63	1	34062	
6,80	109	69	1	39919	
7,00	109	69	1	34063	
7,50	109	69	1	34064	
8,00	117	75	1	34065	
8,50	117	75	1	34066	
9,00	125	81	1	34067	
9,50	125	81	1	72629	
10,00	133	87	1	34068	
10,20	133	87	1	39920	
10,50	133	87	1	74942	
11,00	142	94	1	34069	
11,50	142	94	1	74943	
12,00	151	101	1	34070	
13,00	151	101	1	34071	

* € = 2 uds.

Línea 1 m - Ref. 1004



∅	1	1,5	2	2,5	3	3,25	3,5	4	4,25	4,5	5	5,5	6	6,5	7	7,5	8	9	10
Packs	3	3	5	5	10	5	5	10	5	5	10	5	10	5	5	3	5	3	3

Ref. 4995 - Nº Art. 70933: €

Display 62 - Ref. 1004



∅	7,5	8	8,5	9	10	11	12	13		
Packs	3	5	3	3	3	2	2	2		
∅	4,25	4,25	4,5	5	5	5,5	6	6	6,5	7
Packs	3	2	5	3	2	5	3	2	5	5
∅	2	2,5	2,5	3	3	3,25	3,5	3,5	4	4
Packs	5	3	2	3	2	5	3	2	3	2

Ref. 4995 - N° Art. 34377: €

Display 50 - Ref. 1004 + PREVIOS ROSCADO + Before Threading Ж Pré-Taraudage



∅	8	8,5	9	10	10,2	11	12	13		
Packs	5	3	3	3	2	2	2	2		
∅	4,25	4,5	5	5	5,5	6	6,5	6,8	7	7,5
Packs	5	5	3	2	5	5	5	5	5	3
∅	2	2,5	3	3	3,25	3,3	3,5	4	4	4,2
Packs	5	5	3	2	5	5	5	3	2	3

Ref. 4995 - N° Art. 55633: €

Display 52 - Mixto PRO

MULTI INOX + PARED PRO + MADERA PRO
 Multi-Stainless + Concrete Pro + Wood Pro Drill Bits
 Forets Multi INOX + Béton Pro + Bois Pro



Ref. 1886	∅	3	4	5	6	7	8	9	10	12	14
	Pcs	5	5	10	10	5	5	3	3	3	3
Ref. 1641	∅	3	3	4	4	5	5	6	6	8	10
	Pcs	3	2	3	2	3	2	3	2	5	5
Ref. 1004	∅	1	2	3	3,5	4	4,5	5	6	8	10
	Pcs	2	2	3	3	5	5	5	5	5	3

Ref. 4995 - N° Art. 68575: €





Set **1462**

6 Pcs

Cont. Ø	Nº Art.	€
2 - 3 - 4 - 5 - 6 - 8 mm	34204	



New!

Set **1459**

29 Pcs

Cont. Ø	Nº Art.	€
1 - 13 x 0,5 mm *	15114	

* + Previos Roscado / Before Threading
Pré-Taroudage (3,3 - 4,2 - 6,8 - 10,2 mm)

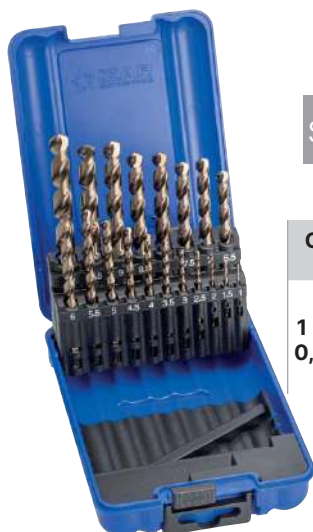

Set **1466**

19 Pcs

Cont. Ø	Nº Art.	€
1 - 10 x 0,5 mm	34201	

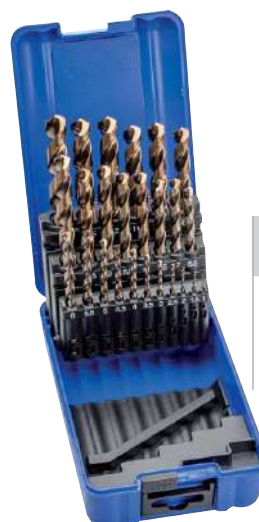

Set **1456**

25 Pcs

Cont. Ø	Nº Art.	€
1 - 13 x 0,5 mm	34199	



Box-Pallet
1021

5 Sets 1466

Cont. Set	Nº Art.	€
1 - 10 x 0,5 mm	80669	



Box-Pallet
1021

5 Sets 1456

Cont. Set	Nº Art.	€
1 - 13 x 0,5 mm	80684	



Ref. **1016**

BROCA MANGO CILÍNDRICO COBALTO

Cobalt Straight Shank Drill Bit
Foret queue cylindrique Cobalt



PROFESSIONAL

HSSE
5% Co

DIN
338 N



Materiales Duros
Hard Materials
Matériaux durs



Video



Aceros
<1300 N/mm²
Steel / Aciers

INOX Ferríticos-Martensíticos
Ferritic-Martensitic Stainless
INOX Ferritiques-Martensitiques

Titanio
Titanium
Titane

D mm	L mm	I mm		Nº Art.	€
0,50	22	6	10	37442	
0,60	27	7	10	37443	
0,70	28	9	10	37444	
0,75	28	9	10	37445	
0,80	30	10	10	37446	
0,90	32	11	10	37447	
1,00	34	12	10	27309	
1,10	36	14	10	20107	
1,20	38	16	10	28861	
1,25	38	16	10	20112	
1,30	38	16	10	20116	
1,40	40	18	10	20125	
1,50	40	18	10	27170	
1,60	43	20	10	20133	
1,70	43	20	10	20142	
1,75	46	22	10	20146	
1,80	46	22	10	20151	
1,90	46	22	10	20155	
2,00	49	24	10	19247	
2,10	49	24	10	20161	
2,20	53	27	10	20166	
2,25	53	27	10	20170	
2,30	53	27	10	20175	
2,40	57	30	10	20184	
2,50	57	30	10	19251	
2,60	57	30	10	20199	
2,65	57	30	10	80109	
2,70	61	33	10	20203	
2,75	61	33	10	19262	
2,80	61	33	10	20209	
2,90	61	33	10	20214	
3,00	61	33	10	19256	

D mm	L mm	I mm		Nº Art.	€
3,05	65	36	10	79847	
3,10	65	36	10	20220	
3,15	65	36	10	79848	
3,20	65	36	10	20224	
3,25	65	36	10	19259	
3,30	65	36	10	20230	
3,40	70	39	10	20235	
3,50	70	39	10	19268	
3,60	70	39	10	20241	
3,70	70	39	10	20245	
3,75	70	39	10	19269	
3,80	75	43	10	20251	
3,90	75	43	10	20256	
4,00	75	43	10	19286	
4,05	75	43	10	18949	
4,10	75	43	10	20265	
4,15	75	43	10	65326	
4,20	75	43	10	20269	
4,25	75	43	10	19271	
4,30	80	47	10	20278	
4,40	80	47	10	20283	
4,50	80	47	10	19274	
4,60	80	47	10	20289	
4,70	80	47	10	20293	
4,75	80	47	10	20298	
4,80	86	52	10	20302	
4,90	86	52	10	20311	
5,00	86	52	10	19277	
5,05	86	52	10	76128	
5,10	86	52	10	20320	
5,15	86	52	10	79849	
5,20	86	52	10	20328	







Ref. **1016**

BROCA MANGO CILÍNDRICO COBALTO

Cobalt Straight Shank Drill Bit
Foret queue cylindrique Cobalt

D mm	L mm	I mm		Nº Art.	€	D mm	L mm	I mm		Nº Art.	€
5,25	86	52	10	19280		9,80	133	87	10	26809	
5,30	86	52	10	20340		9,90	133	87	10	27121	
5,40	93	57	10	20349		10,00	133	87	10	27291	
5,50	93	57	10	19290		10,10	133	87	5	27318	
5,60	93	57	10	20361		10,20	133	87	5	27541	
5,70	93	57	10	20370		10,25	133	87	5	27544	
5,75	93	57	10	20379		10,30	133	87	5	27585	
5,80	93	57	10	20388		10,40	133	87	5	27682	
5,90	93	57	10	20397		10,50	133	87	5	27685	
6,00	93	57	10	19301		10,60	133	87	5	27690	
6,05	101	63	10	79855		10,70	142	94	5	27693	
6,10	101	63	10	20415		10,75	142	94	5	27696	
6,15	101	63	10	79856		10,80	142	94	5	27699	
6,20	101	63	10	20424		10,90	142	94	5	27702	
6,25	101	63	10	20433		11,00	142	94	5	27705	
6,30	101	63	10	20442		11,10	142	94	5	27708	
6,35	101	63	10	79858		11,20	142	94	5	27711	
6,40	101	63	10	20451		11,25	142	94	5	27714	
6,45	101	63	10	64140		11,30	142	94	5	27717	
6,50	101	63	10	27290		11,40	142	94	5	27720	
6,60	101	63	10	20466		11,50	142	94	5	19307	
6,70	101	63	10	20475		11,60	142	94	5	27724	
6,75	109	69	10	20481		11,70	142	94	5	27727	
6,80	109	69	10	20488		11,75	142	94	5	27730	
6,90	109	69	10	20493		11,80	142	94	5	27733	
7,00	109	69	10	19305		11,90	151	101	5	27736	
7,10	109	69	10	20499		12,00	151	101	5	19311	
7,20	109	69	10	20503		12,10	151	101	5	27742	
7,25	109	69	10	20508		12,20	151	101	5	27745	
7,30	109	69	10	20512		12,25	151	101	5	19313	
7,40	109	69	10	20517		12,30	151	101	5	27749	
7,50	109	69	10	19292		12,40	151	101	5	27752	
7,60	117	75	10	20523		12,50	151	101	5	27755	
7,70	117	75	10	20527		12,60	151	101	5	27758	
7,75	117	75	10	20532		12,70	151	101	5	27761	
7,80	117	75	10	20536		12,75	151	101	5	19316	
7,90	117	75	10	20541		12,80	151	101	5	27765	
8,00	117	75	10	20208		12,90	151	101	5	27768	
8,10	117	75	10	22734		13,00	151	101	5	27771	
8,20	117	75	10	22737		13,25	160	108	1	27777	
8,25	117	75	10	22740		13,50	160	108	1	27774	
8,30	117	75	10	22743		13,75	160	108	1	27780	
8,40	117	75	10	22746		14,00	160	108	1	27783	
8,50	117	75	10	19298		14,25	169	114	1	27786	
8,60	125	81	10	22752		14,50	169	114	1	27789	
8,70	125	81	10	22755		14,75	169	114	1	27792	
8,75	125	81	10	22758		15,00	169	114	1	27795	
8,80	125	81	10	22761		15,25	178	120	1	27798	
8,90	125	81	10	22764		15,50	178	120	1	27801	
9,00	125	81	10	20358		15,75	178	120	1	27804	
9,10	125	81	10	22768		16,00	178	120	1	27807	
9,20	125	81	10	22771		16,50	184	125	1	27811	
9,25	125	81	10	22774		17,00	184	125	1	27814	
9,30	125	81	10	22777		17,50	191	130	1	27817	
9,40	125	81	10	22780		18,00	191	130	1	27820	
9,50	125	81	10	20545		18,50	198	135	1	27823	
9,60	133	87	10	22784		19,00	198	135	1	27826	
9,70	133	87	10	23567		19,50	205	140	1	27829	
9,75	133	87	10	26697		20,00	205	140	1	27832	





Cuartos / Quarters / Quarts

∅	1	1,5	2	2,5	3	3,25
Pcs	10	10	40	10	40	10
∅	3,5	4	4,25	4,5	5	
Pcs	10	40	10	10	40	
∅	5,5	6	6,5	7		
Pcs	10	40	10	10		
∅	7,5	8	8,5	9		
Pcs	10	30	10	10		
∅	9,5	10	11	12	13	
Pcs	10	10	5	5	5	

Nº Art. 57525: €

Previos Roscado / Before Threading / Pré-Taradage

∅	1	1,5	2	2,5	3	3,3
Pcs	10	10	40	10	40	10
∅	3,5	4	4,2	4,5	5	
Pcs	10	40	10	10	40	
∅	5,5	6	6,5	6,8		
Pcs	10	40	10	10		
∅	7	7,5	8	8,5		
Pcs	10	10	30	10		
∅	9	9,5	10	10,2	11	12
Pcs	10	10	10	5	5	5

Nº Art. 57978: €

Línea 1 m - Ref. 1016



Cuartos / Quarters / Quarts

1,5 10	3	4	5	6 40	7 10	8 30	9 10	10 10	12 5	mm pcs
	2,5 10	3,5 10	4,5 10							
1 10	2 40	3,25 10	4,25 10	5,5 10	6,5 10	7,5 10	8,5 10	9,5 10	11 5	13 5

Nº Art. 71642: €

Previos Roscado / Before Threading / Pré-Taradage

1,5 10	3	4	5	6 40	7 10	8 30	9,5 10	10,2 5	12 5	mm pcs
	2,5 10	3,5 10	4,5 10				9 10			
1 10	2 40	3,3 10	4,2 10	5,5 10	6,5 10	7,5 10	8,5 10	10 10	11 5	13 5

Nº Art. 71643: €



Expo - Ref. 1016



∅	1	1,5	2	2,5	3	3,5	4	4,5		
Pcs	10	10	10	10	10	10	10	10		
∅	5		5,5		6		6,5		7	
Pcs	10		10		10		10		10	
∅	7,5			8		8,5		9		
Pcs	10			10		10		10		
∅	9,5			10		10,5		11		
Pcs	10			10		5		5		
∅	11,5			12		12,5		13		
Pcs	5			5		5		5		

N° Art. 55449: €



Ref. **1006**

BROCA MANGO CILÍNDRICO COBALTO

Cobalt Straight Shank Drill Bit
Foret queue cylindrique Cobalt



PROFESSIONAL

HSSE
5% Co

DIN
338 N



Materiales Duros
Hard Materials
Matériaux durs

Aceros
<1300 N/mm²
Steel / Aciers

INOX Ferríticos-Martensíticos
Ferritic-Martensitic Stainless
INOX Ferritiques-Martensitiques

Titanio
Titanium
Titane

D mm	L mm	I mm		Nº Art.	€
1,00	34	12	2	30163	*
1,50	40	18	2	30164	*
2,00	49	24	2	18480	*
2,50	57	30	2	30165	*
2,80	61	33	2	79615	*
3,00	61	33	2	18481	*
3,25	65	36	2	30166	*
3,30	65	36	2	34035	*
3,50	70	39	2	30167	*
3,80	75	43	2	79616	*
4,00	75	43	2	18483	*
4,20	75	43	1	34036	
4,25	75	43	1	30168	
4,50	80	47	1	30169	
4,80	86	52	1	79617	
5,00	86	52	1	18484	
5,50	93	57	1	30170	
6,00	93	57	1	18486	
6,50	101	63	1	30171	
6,80	109	69	1	34037	
7,00	109	69	1	18487	
7,50	109	69	1	30172	
8,00	117	75	1	18489	
8,50	117	75	1	30162	
9,00	125	81	1	18490	
9,50	125	81	1	66997	
10,00	133	87	1	18492	
10,20	133	87	1	34038	
10,50	133	87	1	66998	
11,00	142	94	1	30161	
11,50	142	94	1	66999	
12,00	151	101	1	18493	
12,50	151	101	1	67000	
13,00	151	101	1	30160	
14,00	160	108	1	79618	
15,00	169	114	1	79619	



* € = 2 uds.

Línea 1 m - Ref. 1006



∅	1	1,5	2	2,5	3	3,25	3,5	4	4,25	4,5	5	5,5	6	6,5	7	7,5	8	9	10
Packs	5	5	10	5	10	5	10	10	10	10	10	10	10	10	10	10	10	10	10

Ref. 4995 - N° Art. 70936: €



Display 13 - Ref. 1006



∅	7,5	8	8,5	9	10	11	12	13		
Packs	5	5	5	5	5	3	3	3		
∅	4	4,25	4,5	5	5	5,5	6	6	6,5	7
Packs	5	10	5	5	5	5	5	5	5	5
∅	1	1,5	2	2,5	3	3	3,25	3,5	3,5	4
Packs	5	5	10	5	5	5	10	5	5	5

Ref. 4995 - N° Art. 22181: €

Display 48 - Ref. 1006 + PREVIOS ROSCADO + Before Threading Ж Pré-Taraudage



∅	8	8,5	9	10	10,2	11	12	13		
Packs	5	5	5	5	3	3	3	3		
∅	4,25	4,5	5	5	5,5	6	6,5	6,8	7	7,5
Packs	5	5	5	5	5	10	5	5	5	5
∅	1	1,5	2	2,5	3	3,25	3,3	3,5	4	4,2
Packs	5	5	5	5	10	5	5	10	10	5

Ref. 4995 - N° Art. 55621: €

Display 24 - Refs. 1016 - 1010



SETS BROCAS MANGO CILINDRICO HSS + HSSE

HSS + HSSE Straight Shank Drill Bit Sets

Jeux Forets Queue Cylindrique HSS + HSSE

HSSE	Set 1462 - Ref. 1016 Metal Pro 5 Pcs.	Set 1466 - Ref. 1016 Metal Pro 19 Pcs.	Set 1456 - Ref. 1016 Metal Pro 25 Pcs.
	Pcs 5	1	1
HSS	Set 1462 - Ref. 1010 Metal 5 Pcs.	Set 1466 - Ref. 1010 Metal 19 Pcs.	Set 1456 - Ref. 1010 Metal 25 Pcs.
	Pcs 5	2	2

Ref. 4995 - N° Art. 22320: €



Set **1462**

6 Pcs

Cont. Ø	Nº Art.	€
2 - 3 - 4 - 5 - 6 - 8 mm	30231	



New!

Set **1459**

29 Pcs

Cont. Ø	Nº Art.	€
1 - 13 x 0,5 mm *	15073	

* + Previos Roscado / Before Threading
Pré-Taraudage (3,3 - 4,2 - 6,8 - 10,2 mm)



Set **1466**

19 Pcs

Cont. Ø	Nº Art.	€
1 - 10 x 0,5 mm	25274	

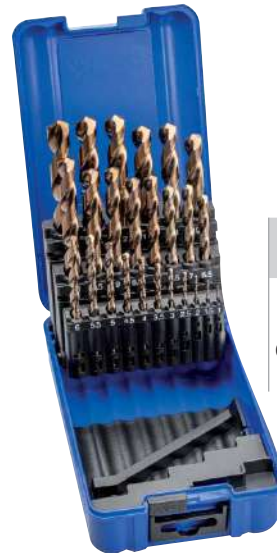

Set **1456**

25 Pcs

Cont. Ø	Nº Art.	€
1 - 13 x 0,5 mm	18370	



Box-Pallet
1016

5 Sets 1466

Cont. Set	Nº Art.	€
1 - 10 x 0,5 mm	80664	



Box-Pallet
1016

5 Sets 1456

Cont. Set	Nº Art.	€
1 - 13 x 0,5 mm	80680	





Set 1407



37 Pcs

Cont. Ø	Nº Art.	€
1 - 10 × 0,25 mm	18367	

Set 1409



49 Pcs

Cont. Ø	Nº Art.	€
1 - 13 × 0,25 mm	18369	

Set 1405



50 Pcs

Cont. Ø	Nº Art.	€
1 - 5,9 × 0,1 mm	10788	

Set 1408



41 Pcs

Cont. Ø	Nº Art.	€
6 - 10 × 0,1 mm	18366	

Set 1406



91 Pcs

Cont. Ø	Nº Art.	€
1-10 × 0,10 mm	56686	

New!

Set 1404

99 Pcs



Cont. Ø	Nº Art.	€
1-10x0,1mm + 10-13x0,5mm *	48821	

* +Previos Roscado / Before Threading
Pré-Taroudage (10-13 mm)

Set 1410

NOVABOX

Mida y ubique las brocas en un solo movimiento
Gauge and place the drills in one single movement

Mesurer et classer les forets en une seule course

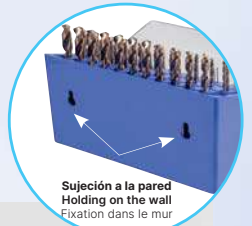

Sujeción a la pared
 Holding on the wall
 Fixation dans le mur

- Almacene y trabaje con este juego de 55 brocas para metal
- Manejo fácil para colocar las brocas en los huecos correspondientes
- Posibilidad de colgar en la pared gracias al colgador trasero
- Storage and management in a 55 metalworking drill set
- Easy use to put drills in suitable socket
- Possibility to hang on the wall
- Stockez et travaillez avec ce jeu de 55 forets
- Utilisation facile pour ranger les forets dans le trou correspondant
- Possibilité d'accrocher au mur grâce au crochet arrière



Agujeros para:

- Brocas desde 1 a 13 mm x 0,5 mm
- Incluye los siguientes diámetros previos al roscado: $\varnothing 2,5 / 3,3 / 4,2 / 5,0 / 6,8 / 8,5 / 10,2 / 12,0$ mm para las métricas de roscado M3 / M4 / M5 / M6 / M8 / M10 / M12 / M14

Holes for:

- Drill diameters from 1 to 13 mm x 0,5 mm
- Includes core hole sizes: $\varnothing 2,5 / 3,3 / 4,2 / 5,0 / 6,8 / 8,5 / 10,2 / 12,0$ mm for threading dimensions M3 / M4 / M5 / M6 / M8 / M10 / M12 / M14

Trous pour:

- Forets de 1 à 13 mm x 0,5 mm
- Inclut les diamètres suivantes pré-taraudage: $\varnothing 2,5 / 3,3 / 4,2 / 5,0 / 6,8 / 8,5 / 10,2 / 12,0$ mm pour les métriques de taraudage M3 / M4 / M5 / M6 / M8 / M10 / M12 / M14

New!



55 Pcs

Cont. Ø	Nº Art.	€
1 - 13 x 0,5 mm	19537	
$\varnothing 1,0 - 4,0$ mm: 3 pcs		
$\varnothing 4,2 - 8,0$ mm: 2 pcs		
$\varnothing 8,50 - 13,0$ mm: 1 pcs		

Sets 1470

170 Pcs



Cont. Ø	Nº Art.	€
1-10 x 0,5 mm	10676	
$\varnothing 1-8$: 10 pcs/ \varnothing		
$\varnothing 8,5-10$: 5 pcs/ \varnothing		

220 Pcs



Cont. Ø	Nº Art.	€
1-13 x 0,5 + 3,3 + 4,2 mm	25391	
$\varnothing 1-8$: 10 pcs/ \varnothing		
$\varnothing 8,5-13$: 5 pcs/ \varnothing		



Ref. **1020**

BROCA MANGO CILÍNDRICO COBALTO INOX

STAINLESS Cobalt Straight Shank Drill Bit
Foret queue cylindrique Cobalt INOX



SPEED MAX

HSSE 5% Co	DIN 338 W			DIN 1412 C ≥ 2 mm				Chapa Sheets Tôle
----------------------	--------------	--	--	-------------------------	--	--	--	--------------------------------



INOX Stainless Steel Acier INOX	Aluminio Aluminium
--	------------------------------

	D	L	I		Nº	€		D	L	I		Nº	€		D	L	I		Nº	€	
	mm	mm	mm		Art.			mm	mm	mm		Art.			mm	mm	mm		Art.		
New!	1,00	34	12	10	14115			5,25	86	52	10	16297			9,40	125	81	5	14026		
New!	1,10	36	14	10	13950			5,30	86	52	10	13984			9,50	125	81	5	16316		
New!	1,20	36	16	10	13951			5,40	93	57	10	13986			9,60	133	87	5	14027		
	1,25	38	16	10	14116			5,50	93	57	10	16298			9,70	133	87	5	14028		
New!	1,30	38	16	10	13953			5,60	93	57	10	13987			9,75	133	87	5	69935		
New!	1,40	40	18	10	13954			5,70	93	57	10	25134			9,80	133	87	5	14029		
	1,50	40	18	10	14117			5,75	93	57	10	16299			9,90	133	87	5	14060		
New!	1,60	43	20	10	13955			5,80	93	57	10	13989			10,00	133	87	5	16318		
New!	1,70	43	20	10	13956			5,90	93	57	10	13991			10,10	133	87	5	14064		
New!	1,80	46	22	10	13958			6,00	93	57	10	16302			10,20	133	87	5	14248		
New!	1,90	46	22	10	13959			6,10	101	63	10	13993			10,25	133	87	5	21634		
	2,00	49	24	10	21615			6,20	101	63	10	13994			10,30	133	87	5	74568		
	2,10	49	24	10	13961			6,25	101	63	10	21627			10,40	133	87	5	74567		
	2,20	53	27	10	13962			6,30	101	63	10	14002			10,50	133	87	5	16320		
	2,25	53	27	10	21616			6,40	101	63	10	14003			10,60	133	87	5	74566		
	2,30	53	27	10	13963			6,50	101	63	10	16304			10,70	142	94	5	74565		
	2,40	57	30	10	13965			6,60	101	63	10	14004			10,75	142	94	5	69934		
	2,50	57	30	10	21618			6,70	101	63	10	14005			10,80	142	94	5	14249		
	2,60	57	30	10	13966			6,75	109	69	10	21628			10,90	142	94	5	74564		
	2,70	61	33	10	13968			6,80	109	69	10	16306			11,00	142	94	5	16321		
	2,75	61	33	10	21625			6,90	109	69	10	14006			11,10	142	94	5	30587		
	2,80	61	33	10	12964			7,00	109	69	10	16307			11,20	142	94	5	14250		
	2,90	61	33	10	13969			7,10	109	69	10	14007			11,25	142	94	5	69932		
	3,00	61	33	10	16283			7,20	109	69	10	14008			11,30	142	94	5	74563		
	3,10	65	36	10	17970			7,25	109	69	10	21631			11,40	142	94	5	74562		
	3,20	65	36	10	16284			7,30	109	69	10	14009			11,50	142	94	5	16322		
	3,25	65	36	10	16285			7,40	109	69	10	14010			11,60	142	94	5	74561		
	3,30	65	36	10	16286			7,50	109	69	10	16309			11,70	142	94	5	74560		
	3,40	70	39	10	13971			7,60	117	75	10	14011			11,75	142	94	5	69931		
	3,50	70	39	10	16287			7,70	117	75	10	14012			11,80	142	94	5	14252		
	3,60	70	39	10	13972			7,75	117	75	10	69940			11,90	151	101	5	74559		
	3,70	70	39	10	14120			7,80	117	75	10	14013			12,00	151	101	5	16323		
	3,75	70	39	10	16288			7,90	117	75	10	14014			12,10	151	101	5	74558		
	3,80	75	43	10	12507			8,00	117	75	10	16311			12,20	151	101	5	14276		
	3,90	75	43	10	13974			8,10	117	75	5	14015			12,25	151	101	5	69929		
	4,00	75	43	10	16289			8,20	117	75	5	14016			12,30	151	101	5	74557		
	4,10	75	43	10	16290			8,25	117	75	5	21633			12,40	151	101	5	74556		
	4,20	75	43	10	16291			8,30	117	75	5	14017			12,50	151	101	5	16324		
	4,25	75	43	10	16292			8,40	117	75	5	14018			12,60	151	101	5	74554		
	4,30	80	47	10	14122			8,50	117	75	5	16313			12,70	151	101	5	74553		
	4,40	80	47	10	13975			8,60	125	81	5	14019			12,75	151	101	5	69928		
	4,50	80	47	10	16293			8,70	125	81	5	14020			12,80	151	101	5	14288		
	4,60	80	47	10	13979			8,75	125	81	5	69938			12,90	151	101	5	74552		
	4,70	80	47	10	13981			8,80	125	81	5	14021			13,00	151	101	5	16325		
	4,75	80	47	10	16294			8,90	125	81	5	14022			New!	13,50	160	108	1	25995	
	4,80	86	52	10	14123			9,00	125	81	5	16314			New!	14,00	160	114	1	25996	
	4,90	86	52	10	13983			9,10	125	81	5	14023			New!	14,50	169	114	1	25999	
	5,00	86	52	10	16295			9,20	125	81	5	14024			New!	15,00	169	114	1	26000	
	5,10	86	52	10	16296			9,25	125	81	5	69937			New!	15,25	178	120	1	26001	
	5,20	86	52	10	28626			9,30	125	81	5	14025			New!	15,50	178	120	1	26004	
															New!	16,00	178	120	1	26005	



Expo - Ref. 1020



Cuartos / Quarters / Quarts

∅	1	1,5	2	2,5	3	3,25
Pcs	10	10	20	10	20	10
∅	3,5	4	4,25	4,5	5	
Pcs	20	20	10	10	20	
∅	5,5	6		6,5	7	
Pcs	10	20		10	10	
∅	7,5	8		8,5	9	
Pcs	10	10		5	10	
∅	9,5	10	11	12	13	
Pcs	5	5	5	5	5	

Nº Art. 57526: €

Previos Roscado / Before Threading / Pré-Taraudage

∅	1	1,5	2	2,5	3	3,3
Pcs	10	10	20	10	20	10
∅	3,5	4	4,2	4,5	5	
Pcs	20	20	10	10	20	
∅	5,5	6		6,5	6,8	
Pcs	10	20		10	10	
∅	7	7,5	8	8,5		
Pcs	10	10	10	5		
∅	9	9,5	10	10,2	11	12
Pcs	10	5	5	5	5	5

Nº Art. 57979: €

Línea 1 m - Ref. 1020



Cuartos / Quarters / Quarts

1,5 10	3	4	5	6 20	7 10	8 10	9 10	10 5	12 5	mm pcs
	2,5	3,5	4,5							
1 10	2	3,25	4,25	5,5 10	6,5 10	7,5 10	8,5 5	9,5 5	11 5	13 5

Nº Art. 71644: €

Previos Roscado / Before Threading / Pré-Taraudage

1,5 10	3	4	5	6 20	7 10	8 10	9,5 5	10,2 5	12 5	mm pcs
	2,5	3,5	4,5							
1 10	2	3,3	4,2	5,5 10	6,5 10	7,5 10	8,5 5	10 5	11 5	13 5

Nº Art. 71646: €



Expo - Ref. 1020



200 Pcs

∅	1	1,5	2	2,5	3	3,5	4	4,5
Pcs	10	10	10	10	10	10	10	10
∅	5	5,5	6	6,5	7			
Pcs	10	10	10	10	10			
∅	7,5	8	8,5	9				
Pcs	10	10	5	5				
∅	9,5	10	10,5	11				
Pcs	5	5	5	5				
∅	11,5	12	12,5	13				
Pcs	5	5	5	5				

N° Art. 55446: €



Ref. **1005**

BROCA MANGO CILÍNDRICO COBALTO INOX
STAINLESS Cobalt Straight Shank Drill Bit
 Foret queue cylindrique Cobalt **INOX**



SPEED MAX

HSSE 5% Co	DIN 338 W				 < 5 mm	Chapa Sheets Tôle
----------------------	--------------	--	--	--	------------	--------------------------------

INOX Stainless Steel Acier INOX	Aluminio Aluminium
--	------------------------------

D mm	L mm	I mm		Nº Art.	€
1,00	34	12	2	70000	*
1,50	38	16	2	70001	*
2,00	49	24	2	24757	*
2,50	57	30	2	24758	*
3,00	61	33	2	24759	*
3,25	65	36	2	24760	*
3,30	65	36	2	55632	*
3,50	70	39	2	24761	*
4,00	75	43	2	24762	*
4,20	75	43	1	55635	
4,25	75	43	1	24763	
4,50	80	47	1	24764	
5,00	86	52	1	24765	
5,50	93	57	1	24766	
6,00	93	57	1	24767	
6,50	101	63	1	24768	
6,80	109	69	1	55636	
7,00	109	69	1	24769	
7,50	109	69	1	24770	
8,00	117	75	1	24771	
8,50	117	75	1	24772	
9,00	125	81	1	24773	
10,00	133	87	1	24774	
10,20	133	87	1	55638	
11,00	142	94	1	24775	
12,00	151	101	1	24776	
13,00	151	101	1	24777	



* € = 2 uds.



Línea 1 m - Ref. 1005



∅	1	1,5	2	2,5	3	3,25	3,5	4	4,25	4,5	5	5,5	6	6,5	7	7,5	8	9	10
Packs	3	3	5	5	10	5	5	10	5	5	10	5	10	5	5	3	5	3	3

Ref. 4995 - Nº Art. 70940: €

Display 16 - Ref. 1005



∅	7,5	8	8,5	9	10	11	12	13		
Packs	5	5	5	5	3	2	2	2		
∅	4,25	4,25	4,5	5	5	5,5	6	6	6,5	7
Packs	3	2	5	5	5	5	3	2	5	5
∅	2	2,5	2,5	3	3	3,25	3,5	3,5	4	4
Packs	5	3	2	5	5	5	3	2	5	5

Ref. 4995 - Nº Art. 22497: €

Display 49 - Ref. 1005 + PREVIOS ROSCADO + Before Threading Ж Прэ-Тараудажэ



∅	8	8,5	9	10	10,2	11	12	13		
Packs	5	3	3	3	3	2	2	2		
∅	4,25	4,5	5	5	5,5	6	6,5	6,8	7	7,5
Packs	5	5	5	5	5	10	5	5	5	3
∅	2	2,5	3	3	3,25	3,3	3,5	4	4	4,2
Packs	5	5	5	5	5	5	5	5	5	5

Ref. 4995 - Nº Art. 55629: €



Set 1462

6 Pcs

Cont. Ø	Nº Art.	€
2 - 3 - 4 - 5 - 6 - 8 mm	25367	



New!

Set 1459

29 Pcs

Cont. Ø	Nº Art.	€
1 - 13 x 0,5 mm *	15113	

* + Previos Roscado / Before Threading
Pré-Tarudage (3,3 - 4,2 - 6,8 - 10,2 mm)

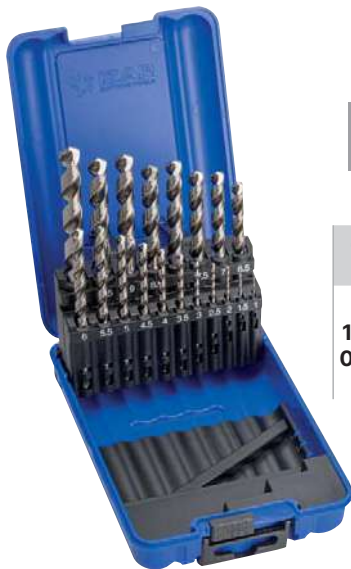

Set 1466

19 Pcs

Cont. Ø	Nº Art.	€
1 - 10 x 0,5 mm	24636	



Set 1456

25 Pcs

Cont. Ø	Nº Art.	€
1 - 13 x 0,5 mm	24638	



Box-Pallet
1020

5 Sets 1466

Cont. Set	Nº Art.	€
1 - 10 x 0,5 mm	80667	



Box-Pallet
1020

5 Sets 1456

Cont. Set	Nº Art.	€
1 - 13 x 0,5 mm	80682	



Ref. **1027**

BROCA MANGO REBAJADO COBALTO

Cobalt Reduced Shank Drill Bit
Foret queue reduite Cobalt



Aceros
<1300 N/mm²
Steel / Aciers

INOX Ferríticos-Martensíticos
Ferritic-Martensitic Stainless
INOX Ferritiques-Martensitiques

Titanio
Titanium
Titane

D mm	d mm	L mm	l mm		Nº Art.	€
10,50	10,00	133	87	1	54954	
11,00	10,00	142	94	1	54955	
11,50	10,00	142	94	1	54956	
12,00	10,00	151	101	1	22346	
12,50	10,00	151	101	1	54957	
13,00	10,00	151	101	1	22347	
13,50	12,70	160	108	1	49200	
14,00	12,70	160	108	1	22344	
14,50	12,70	169	114	1	49201	
15,00	12,70	169	114	1	22348	
15,50	12,70	178	120	1	49223	
16,00	12,70	178	120	1	22349	
16,50	12,70	184	125	1	54979	
17,00	12,70	184	125	1	22350	
17,50	12,70	191	130	1	54958	
18,00	12,70	191	130	1	22351	
18,50	12,70	198	135	1	54959	
19,00	12,70	198	135	1	22353	
19,50	12,70	205	140	1	54960	
20,00	12,70	205	140	1	22354	
20,50	12,70	205	145	1	66946	
21,00	12,70	205	145	1	66941	
21,50	12,70	210	150	1	66945	
22,00	12,70	210	150	1	66940	
22,50	12,70	210	150	1	66944	
23,00	12,70	210	150	1	66939	
23,50	12,70	220	160	1	66943	
24,00	12,70	220	160	1	66938	
24,50	12,70	220	160	1	66942	
25,00	12,70	220	160	1	66937	



Línea 1 m - Ref. 1027



∅	12	12,5	13	13,5	14	15	15,5	16	16,5	17	17,5	18	18,5	19	19,5	20
Pcs	1	1	1	1	1	1	1	1	1	1	1	1	1	1	1	1

Ref. 4995 - Nº Art. 72076: €



Ref. **9015**

BROCA ROMPE BOMBILLOS CERRADURAS

Cylinder Lock Breaker Drill Bit

Foret destructeur de trous de serrure



MD
HM
Carbure



D mm	d mm	L mm	I mm	Nº Art.	€
6	6	60	34	70727	



- Metal Duro monoblock de última generación
- Punta auto centrante
- Afilado especial IZAR
- Precisión y buen acabado
- Apto para bombillos de latón y acero o bombillos de seguridad.
- Last generation monoblock Solid Carbide
- Autocentering point
- IZAR special Sharpening
- Good Precision and Finishing
- Suitable for brass, steel or security cylinder locks
- Carbure monoblock dernière génération
- Pointe autocentrante
- Affûtage spéciale IZAR
- Précision et bonne qualité de finition
- Conçu pour serrure en laiton et acier ou serrure de sécurité

Ref. **9289**

FRESA MICROGRANO CERRADURAS

Lock Micrograin End Mill

Fraise micrograin serrures

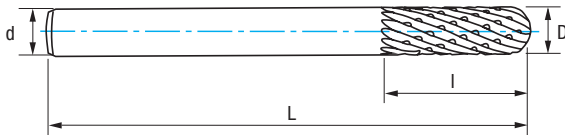

MD
HM
Carbure



D mm	d mm	L mm	I mm	Nº Art.	€	Nº Art. ALTIN	€
3	6	60	15	53893		14935	
4	6	60	15	53894		14941	
6	6	60	18	53895		14944	



SET CERRAJEROS
Locksmith Set
Jeu serruriers



4 Pcs

Cont.	Nº Art.	€
Ref. 9015: ø 6 mm	53879	
Ref. 9289: ø 3-4-6 mm		



Modern Production Facilities

izartool.com/en



Ref. **9100**

BROCA MANGO CILÍNDRICO PUNTA METAL DURO

Carbide Tipped Straight Shank Drill Bit
Foret queue cylindrique pointe carbure



**MD
HM**
Carbure

DIN
338 N



Aceros
<1000 N/mm²
Steel / Aciers

Aceros
<1300 N/mm²
Steel / Aciers

Fundición
Cast Iron
Fonte

Titanio
Titanium
Titane

Cobre
Copper
Cuivre

Duroplásticos
Hard Plastics
Plastiques durs

D mm	L mm	I mm		Nº Art.	€
2,00	49	24	1	71429	
2,50	57	30	1	71444	
2,70	57	30	1	46916	
3,00	61	33	1	71459	
3,10	61	33	1	46917	
3,20	65	36	1	23058	
3,30	65	36	1	26716	
3,40	70	39	1	29479	
3,50	70	39	1	71474	
3,60	70	39	1	52285	
4,00	75	43	1	71489	
4,10	75	43	1	46918	
4,20	75	43	1	22016	
4,50	80	47	1	71504	
4,60	80	47	1	26963	
4,70	80	47	1	17101	
4,80	86	52	1	26964	
5,00	86	52	1	71516	
5,10	86	52	1	23059	
5,20	86	52	1	67682	
5,50	93	57	1	71531	
5,60	93	57	1	32603	
5,70	93	57	1	23889	
5,80	93	57	1	54039	
6,00	93	57	1	71543	
6,10	101	63	1	23891	
6,20	101	63	1	32691	

D mm	L mm	I mm		Nº Art.	€
6,30	101	63	1	32692	
6,50	101	63	1	71558	
6,60	101	63	1	30614	
6,80	109	69	1	23893	
7,00	109	69	1	71573	
7,50	109	69	1	71585	
7,80	117	75	1	23914	
8,00	117	75	1	71600	
8,50	117	75	1	71615	
8,60	125	81	1	27007	
9,00	125	81	1	71630	
9,50	125	81	1	71645	
10,00	133	87	1	71660	
10,20	133	87	1	27008	
10,50	133	87	1	71663	
11,00	142	94	1	71666	
11,50	142	94	1	71672	
12,00	151	101	1	71675	
12,50	151	101	1	71681	
13,00	151	101	1	71684	
14,00	160	108	1	71690	
15,00	169	114	1	71696	
16,00	178	120	1	71702	
17,00	184	125	1	71705	
18,00	191	130	1	71711	
19,00	198	135	1	71717	
20,00	205	140	1	71723	



NUEVA PUNTA

Máximo rendimiento

NEW TIP

Maximum performance

NOUVELLE POINTE

Rendement maximal

Ref. **1015**

BROCA MANGO CILÍNDRICO ZIRKONIO

Zirkonio Straight Shank Drill Bit
Foret queue cylindrique Zirkonio



ZIRKONIO



HSS

Zirkonio

DIN 338 N



Tol. D h8



Video

Aceros
<850 N/mm²
Steel / Aciers

Fundición
Cast Iron
Fonte

Aluminio
Aluminium

Ángulo punta 118°

- Autocentradora
- Ideal taladro portátil
- Geometría especial diseñada para reducir el esfuerzo de corte

118° Point Angle

- Autocentering
- Ideal Portable Drilling Machine
- Special Geometry designed for reducing cutting effort

Angle Pointe 118°

- Autocentreur
- Perceuse à main
- Géométrie pour réduire l'effort de coupe

Nuevo recubrimiento Zirkonio de última generación por PVD

- Basado en ZRN
- Bajo coeficiente de fricción
- Muy resistente a la corrosión
- Adecuado para materiales no férricos
- Evita la adherencia de material en el filo de corte

Latest generation Zirkonio coating by PVD

- Based on ZRN
- Low Friction Coefficient
- High Corrosion Resistant
- Appropriate for Non-Ferrous Materials
- Built-Up Edge avoided

Nouveau revêtement Zirkonio dernière génération par PVD

- Base ZRN
- Faible coefficient friction
- Résistant à l'usure
- Recommandé pour aciers non ferreux
- Évite l'adhérence sur les filets de coupe

D mm	L mm	I mm	Art.	N° Art.	€
1,00	34	12	10	59101	
1,10	36	14	10	62815	
1,20	38	16	10	62819	
1,25	38	16	10	68271	
1,30	38	16	10	62820	
1,40	40	18	10	62821	
1,50	40	18	10	59103	
1,60	43	20	10	62822	
1,70	43	20	10	62823	
1,75	46	22	10	68274	
1,80	46	22	10	62824	
1,90	46	22	10	62826	
2,00	49	24	10	59100	
2,10	49	24	10	62827	
2,20	53	27	10	62828	
2,25	53	27	10	68363	
2,30	53	27	10	62829	
2,40	57	30	10	62830	
2,50	57	30	10	59104	
2,60	57	30	10	62831	

D mm	L mm	I mm	Art.	N° Art.	€
2,70	61	33	10	62832	
2,75	61	33	10	68364	
2,80	61	33	10	62833	
2,90	61	33	10	62834	
3,00	61	33	10	59115	
3,10	65	36	10	62835	
3,20	65	36	10	59118	
3,25	65	36	10	59121	
3,30	65	36	10	59124	
3,40	70	39	10	62836	
3,50	70	39	10	59127	
3,60	70	39	10	62837	
3,70	70	39	10	62838	
3,75	70	39	10	68365	
3,80	75	43	10	62839	
3,90	75	43	10	62841	
4,00	75	43	10	59131	
4,10	75	43	10	62842	
4,20	75	43	10	59133	
4,25	75	43	10	59134	

D mm	L mm	I mm	Art.	N° Art.	€
4,30	80	47	10	62843	
4,40	80	47	10	62844	
4,50	80	47	10	59137	
4,60	80	47	10	62845	
4,70	80	47	10	62846	
4,75	80	47	10	68350	
4,80	86	52	10	62847	
4,90	86	52	10	62848	
5,00	86	52	10	58831	
5,10	86	52	10	62849	
5,20	86	52	10	59139	
5,25	86	52	10	68366	
5,30	86	52	10	62850	
5,40	93	57	10	62851	
5,50	93	57	10	59140	
5,60	93	57	10	62852	
5,70	93	57	10	62853	
5,75	93	57	10	68367	
5,80	93	57	10	62854	
5,90	93	57	10	62855	



Ref. **1015**

BROCA MANGO CILÍNDRICO ZIRKONIO

Zirkonio Straight Shank Drill Bit
Foret queue cylindrique Zirkonio

Cont.

D mm	L mm	I mm		Nº Art.	€	D mm	L mm	I mm		Nº Art.	€	D mm	L mm	I mm		Nº Art.	€
6,00	93	57	10	59145		8,30	117	75	5	62873		10,80	142	94	5	62895	
6,10	101	63	10	62856		8,40	117	75	5	62874		10,90	172	94	5	62896	
6,20	101	63	10	62857		8,50	117	75	5	59158		11,00	142	94	5	59170	
6,25	101	63	10	68368		8,60	125	81	5	62875		11,10	142	94	5	62898	
6,30	101	63	10	62858		8,70	125	81	5	62876		11,20	142	94	5	62900	
6,40	101	63	10	62859		8,75	125	81	5	68373		11,30	142	94	5	62902	
6,50	101	63	10	59148		8,80	125	81	5	62877		11,40	142	94	5	62904	
6,60	101	63	10	62860		8,90	125	81	5	62878		11,50	142	94	5	59172	
6,70	101	63	10	62861		9,00	125	81	5	59161		11,60	172	94	5	62905	
6,75	109	69	10	68369		9,10	125	81	5	62879		11,70	142	94	5	62907	
6,80	109	69	10	59149		9,20	125	81	5	62880		11,80	142	94	5	62908	
6,90	109	69	10	62862		9,25	125	81	5	68374		11,90	151	101	5	62909	
7,00	109	69	10	59151		9,30	125	81	5	62881		12,00	151	101	5	59173	
7,10	109	69	10	62863		9,40	125	81	5	62882		12,10	151	101	5	62910	
7,20	109	69	10	62864		9,50	125	81	5	59163		12,20	151	101	5	62918	
7,25	109	69	10	68370		9,60	133	87	5	62883		12,30	151	101	5	62921	
7,30	109	69	10	62865		9,70	133	87	5	62884		12,40	151	101	5	62923	
7,40	109	69	10	62866		9,75	133	87	5	68375		12,50	151	101	5	59176	
7,50	109	69	10	59155		9,80	133	87	5	62886		12,60	151	101	5	62927	
7,60	117	75	10	62867		9,90	133	87	5	62887		12,70	151	101	5	62930	
7,70	117	75	10	62868		10,00	133	87	5	59164		12,80	151	101	5	62932	
7,75	117	75	10	68371		10,10	133	87	5	62888		12,90	151	101	5	62934	
7,80	117	75	10	62869		10,20	133	87	5	59166		13,00	151	101	5	59179	
7,90	117	75	10	62870		10,30	133	87	5	62889		New! 13,50	160	108	1	25147	
8,00	117	75	10	59157		10,40	133	87	5	62890		New! 14,00	160	108	1	25154	
8,10	117	75	5	62871		10,50	133	87	5	59167		New! 14,50	169	114	1	25155	
8,20	117	75	5	62872		10,60	133	87	5	62892		New! 15,00	169	114	1	25156	
8,25	117	75	5	68372		10,70	142	94	5	62893		New! 16,00	178	120	1	25157	

Expo - Ref. 1015



Cuartos / Quarters / Quarts

Ø	1	1,5	2	2,5	3	3,25
Pcs	10	10	30	10	50	10
Ø	3,5	4	4,25	4,5	5	
Pcs	10	50	10	10	40	
Ø	5,5	6	6,5	7		
Pcs	10	50	10	10		
Ø	7,5	8	8,5	9		
Pcs	10	20	10	10		
Ø	9,5	10	11	12	13	
Pcs	5	10	5	5	5	
Nº Art. 15999:		€				

Previos Roscado / Before Threading / Pré-Taraudage

Ø	1	1,5	2	2,5	3	3,3	
Pcs	10	10	30	10	50	10	
Ø	3,5	4	4,2	4,5	5		
Pcs	10	50	10	10	40		
Ø	5,5	6	6,5	6,8			
Pcs	10	50	10	10			
Ø	7	7,5	8	8,5			
Pcs	10	10	20	10			
Ø	9	9,5	10	10,2	11	12	13
Pcs	10	5	10	5	5	5	5
Nº Art. 16001:		€					



Línea 1 m - Ref. 1015



Cuartos / Quarters / Quarts

1,5 10	3 50	4 50	5 40	6 50	7 10	8 20	9 10	10 10	12 5	mm pcs
	2,5 10	3,5 10	4,5 10							
1 10	2 30	3,25 10	4,25 10	5,5 10	6,5 10	7,5 10	8,5 10	9,5 5	11 5	13 5

N° Art. 71396: €

Previos Roscado / Before Threading / Pré-Tarudage

1,5 10	3 50	4 50	5 40	6 50	7 10	8 20	9,5 5	10,2 5	12 5	mm pcs
	2,5 10	3,5 10	4,5 10		6,8 10		9 10			
1 10	2 30	3,3 10	4,2 10	5,5 10	6,5 10	7,5 10	8,5 10	10 10	11 5	13 5

N° Art. 71638: €



Expo - Ref. 1015



200 Pcs

∅	1	1,5	2	2,5	3	3,5	4	4,5		
Pcs	10	10	10	10	10	10	10	10		
∅	5		5,5		6		6,5		7	
Pcs	10		10		10		10		10	
∅	7,5			8		8,5		9		
Pcs	10			10		5		5		
∅	9,5			10		10,5		11		
Pcs	5			5		5		5		
∅	11,5			12		12,5		13		
Pcs	5			5		5		5		

N° Art. 14229: €



Ref. **1065**

BROCA MANGO CILÍNDRICO ZIRKONIO

Zirkonio Straight Shank Drill Bit
Foret queue cylindrique Zirkonio

New!



D mm	L mm	I mm		Nº Art.	€
1,00	34	12	2	14509	*
1,50	40	18	2	14547	*
2,00	49	24	2	14592	*
2,50	57	30	2	14640	*
3,00	61	33	2	14682	*
3,25	65	36	2	14694	*
3,30	65	36	2	14700	*
3,50	70	39	2	14731	*
4,00	75	43	2	14734	*
4,20	75	43	1	14743	
4,25	75	43	1	14749	
4,50	80	47	1	14757	
5,00	86	52	1	14758	
5,50	93	57	1	14772	
6,00	93	57	1	14776	
6,50	101	63	1	14784	

D mm	L mm	I mm		Nº Art.	€
6,80	109	69	1	25971	
7,00	109	69	1	14787	
7,50	109	69	1	14794	
8,00	117	75	1	14796	
8,50	117	75	1	14799	
9,00	125	81	1	14805	
9,50	125	81	1	14809	
10,00	133	87	1	14811	
10,20	133	87	1	14812	
10,50	133	87	1	14814	
11,00	142	94	1	14818	
11,50	142	94	1	14821	
12,00	151	101	1	14823	
12,50	151	101	1	40206	
13,00	151	101	1	14824	

* € = 2 uds.

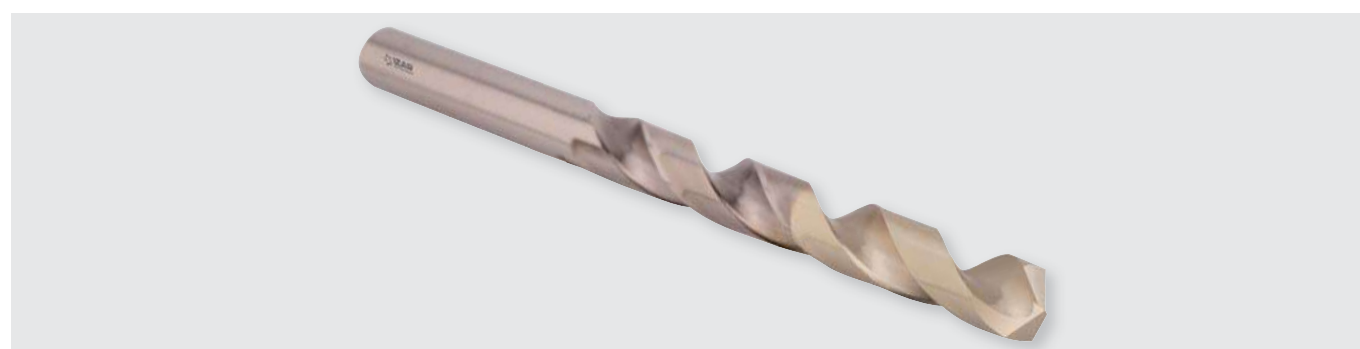



Set 1462

6 Pcs

Cont. Ø	Nº Art.	€
2 - 3 - 4 - 5 - 6 - 8 mm	59236	



New!

Set 1459

29 Pcs

Cont. Ø	Nº Art.	€
1 - 13 x 0,5 mm *	15115	

* + Previos Roscado Before Threading Pré-Taraudage (3,3 - 4,2 - 6,8 - 10,2 mm)

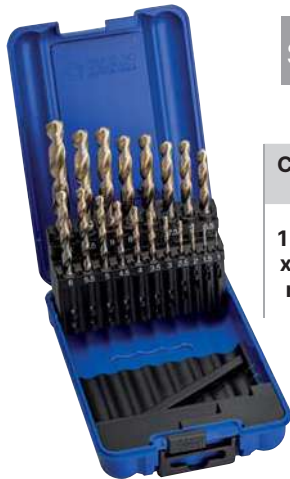

Set 1466

19 Pcs

Cont. Ø	Nº Art.	€
1 - 10 x 0,5 mm	59234	



Set 1456

25 Pcs

Cont. Ø	Nº Art.	€
1 - 13 x 0,5 mm	59235	



Box-Pallet 1015

5 Sets 1466

Cont. Set	Nº Art.	€
1 - 10 x 0,5 mm	80662	



Box-Pallet 1015

5 Sets 1456

Cont. Set	Nº Art.	€
1 - 13 x 0,5 mm	80678	

Set 1405



New!

50 Pcs

Cont. Ø	Nº Art.	€
1 - 5,9 × 0,1 mm	59126	

Set 1408



New!

41 Pcs

Cont. Ø	Nº Art.	€
6 - 10 × 0,1 mm	59129	

Set 1406

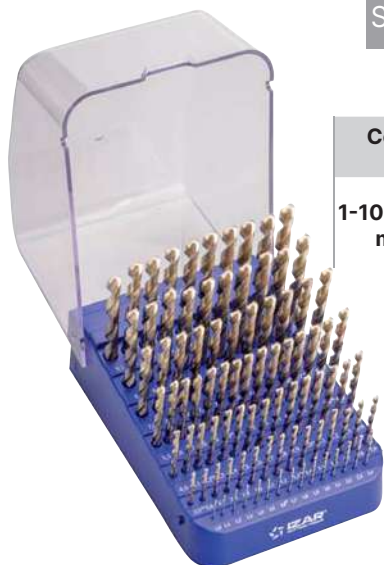

91 Pcs

Cont. Ø	Nº Art.	€
1-10 × 0,10 mm	56686	

Set 1404

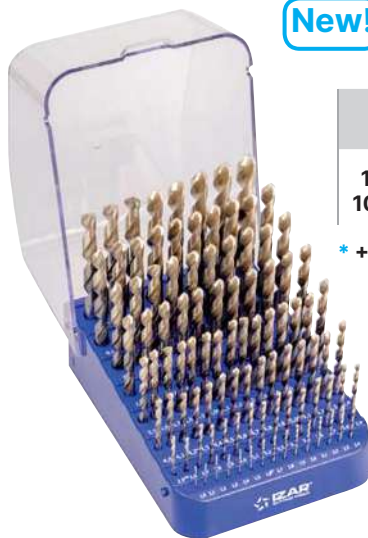

New!

99 Pcs

Cont. Ø	Nº Art.	€
1-10x0,1mm + 10-13x0,5mm*	48824	

* + Previos Roscado / Before Threading
Pré-Taroudage (10-13 mm)

Set 1410

NOVABOX

New!



55 Pcs

Cont. Ø	Nº Art.	€
1 - 13 × 0,5 mm	28360	
Ø1,0 - 4,0 mm: 3 pcs		
Ø4,2 - 8,0 mm: 2 pcs		
Ø8,50 - 13,0 mm: 1 pcs		





Ref. **1010**

BROCA MANGO CILÍNDRICO HSS

HSS Straight Shank Drill Bit
Foret queue cylindrique HSS



CLASSIQUE



HSS	HSS + TIN	DIN 338 N			Usos General General Purpose Utilisation générale
-----	-----------	-----------	--	--	--

Aceros <850 N/mm² Steel / Aciers	Fundición Cast Iron Fonte	Aluminio Aluminium
---	--	-------------------------------------



D	L	I		Nº Art. HSS	€	Nº Art. TIN	€	D	L	I		Nº Art. HSS	€	Nº Art. TIN	€
0,30	19	3	10	17996				2,20	53	27	10	10043		18338	
0,35	19	4	10	17999				2,25	53	27	10	10046		18341	
0,40	20	5	10	18002				2,30	53	27	10	10049		18344	
0,45	20	5	10	18005				2,35	53	27	10	18080			
0,50	22	6	10	18008				2,40	57	30	10	10052		18347	
0,55	24	7	10	18011				2,45	57	30	10	18083			
0,60	24	7	10	18014				2,50	57	30	10	10055		18350	
0,65	26	8	10	18017				New! 2,55	57	30	10	18086		24315	
0,70	28	9	10	18020				2,60	57	30	10	10058		18353	
0,75	28	9	10	18023				2,65	57	30	10	18089			
0,80	30	10	10	18026				2,70	61	33	10	10061		27166	
0,85	30	10	10	18029				2,75	61	33	10	10064		18356	
0,90	32	11	10	18032				2,80	61	33	10	10067		18359	
0,95	32	11	10	18035				2,85	61	33	10	18092			
1,00	34	12	10	10001		18305		2,90	61	33	10	10070		27088	
New! 1,05	34	12	10	18038		53352		2,95	61	33	10	18095			
1,10	36	14	10	10004		15056		3,00	61	33	10	10073		18362	
1,15	36	14	10	18041				3,05	65	36	10	18098		17358	
1,20	38	16	10	10007		18308		3,10	65	36	10	10076		18365	
1,25	38	16	10	10010		27087		3,15	65	36	10	27343		29078	
1,30	38	16	10	10013		18311		3,20	65	36	10	10079		18368	
1,35	40	18	10	18050				3,25	65	36	10	10082		18371	
1,40	40	18	10	10016		27337		3,30	65	36	10	10085		18374	
1,45	40	18	10	18053				New! 3,35	65	36	10	27345		24316	
1,50	40	18	10	10019		18314		3,40	70	39	10	10088		27322	
1,55	43	20	10	18059				3,45	70	39	10	27346		21777	
1,60	43	20	10	10022		18317		3,50	70	39	10	10091		18377	
1,65	43	20	10	18062				3,55	70	39	10	18101			
1,70	43	20	10	10025		18320		3,60	70	39	10	10094		27323	
1,75	46	22	10	10028		18323		3,65	70	39	10	18104			
1,80	46	22	10	10031		18326		3,70	70	39	10	10097		18380	
New! 1,85	46	22	10	18068		77801		3,75	70	39	10	10100		18383	
1,90	46	22	10	10034		18329		3,80	75	43	10	10103		18386	
1,95	49	24	10	18071				3,85	75	43	10	18107		79546	
2,00	49	24	10	10037		18332		3,90	75	43	10	10106		27165	
New! 2,05	49	24	10	18074		14277		3,95	75	43	10	18110			
2,10	49	24	10	10040		18335		4,00	75	43	10	10109		18389	
2,15	53	27	10	18077				4,05	75	43	10	27349			







Ref. **1010**

BROCA MANGO CILÍNDRICO HSS

HSS Straight Shank Drill Bit
Foret queue cylindrique HSS

D mm	L mm	I mm		Nº Art. HSS	€	Nº Art. TIN	€
4,10	75	43	10	10112		18392	
4,15	75	43	10	27350			
4,20	75	43	10	10115		18395	
4,25	75	43	10	10118		18398	
4,30	80	47	10	10121		18401	
4,35	80	47	10	18113			
4,40	80	47	10	10124		18404	
4,45	80	47	10	18116			
4,50	80	47	10	10127		18407	
4,55	80	47	10	27288			
4,60	80	47	10	10130		18410	
4,65	80	47	10	27352			
4,70	80	47	10	10133		18413	
4,75	80	47	10	10136		18416	
4,80	86	52	10	10139		18419	
4,85	86	52	10	18119			
4,90	86	52	10	10142		18422	
4,95	86	52	10	18122			
5,00	86	52	10	10145		18425	
5,05	86	52	10	18125		21749	
5,10	86	52	10	10148		18428	
5,15	86	52	10	27330			
5,20	86	52	10	10151		18431	
5,25	86	52	10	10154		18434	
5,30	86	52	10	10157		18437	
5,35	93	57	10	18131			
5,40	93	57	10	10160		27292	
5,45	93	57	10	27354			
5,50	93	57	10	10163		18440	
5,55	93	57	10	27356		65683	
5,60	93	57	10	10166		18443	
5,65	93	57	10	18134			
5,70	93	57	10	10169		18446	
5,75	93	57	10	10172		18449	
5,80	93	57	10	10175		18452	
5,85	93	57	10	27357			
5,90	93	57	10	10178		18455	
5,95	93	57	10	27358			
6,00	93	57	10	10181		18458	
6,05	101	63	10	27359		17594	
6,10	101	63	10	10184		18461	
6,15	101	63	10	27360		79817	
6,20	101	63	10	10187		18464	
6,25	101	63	10	10190		18467	
6,30	101	63	10	10193		27324	
6,35	101	63	10	27361			
6,40	101	63	10	10196		18470	
New! 6,45	101	63	10	18137		24317	
6,50	101	63	10	10199		18473	
6,55	101	63	10	18140			
6,60	101	63	10	10202		18476	
New! 6,65	101	63	10	27362		24318	
6,70	101	63	10	10205		27333	
6,75	109	69	10	10208		18479	
6,80	109	69	10	10211		18482	
6,85	109	69	10	18143			
6,90	109	69	10	10214		18485	
6,95	109	69	10	27316			
7,00	109	69	10	10217		18488	
7,05	109	69	10	27363		79818	

D mm	L mm	I mm		Nº Art. HSS	€	Nº Art. TIN	€
7,10	109	69	10	10220		18491	
7,15	109	69	10	27364			
7,20	109	69	10	10223		18494	
7,25	109	69	10	10226		18497	
7,30	109	69	10	10229		18500	
7,35	109	69	10	27365			
7,40	109	69	10	10232		27150	
7,45	109	69	10	27366			
7,50	109	69	10	10235		18503	
7,55	117	75	10	27369			
7,60	117	75	10	10238		27313	
7,65	117	75	10	27368			
7,70	117	75	10	10241		18506	
7,75	117	75	10	10244		27272	
7,80	117	75	10	10247		18509	
7,85	117	75	10	27370			
7,90	117	75	10	10250		18512	
7,95	117	75	10	27372			
8,00	117	75	10	10253		18515	
8,05	117	75	10	27373		39695	
8,10	117	75	10	10256		26675	
8,15	117	75	10	27374			
8,20	117	75	10	10259		26678	
8,25	117	75	10	10262		18518	
8,30	117	75	10	10265		27311	
8,35	117	75	10	27376			
8,40	117	75	10	10268		26681	
8,45	117	75	10	27377			
8,50	117	75	10	10271		18521	
8,55	125	81	10	27378			
8,60	125	81	10	10274		18524	
8,65	125	81	10	27379			
8,70	125	81	10	10277		18527	
8,75	125	81	10	10280		18530	
8,80	125	81	10	10283		18533	
8,85	125	81	10	27381			
8,90	125	81	10	10286		18536	
8,95	125	81	10	27383			
9,00	125	81	10	10289		18539	
9,05	125	81	10	27382			
9,10	125	81	10	10292		26684	
9,15	125	81	10	27385			
9,20	125	81	10	10295		27553	
9,25	125	81	10	10298		27273	
9,30	125	81	10	10301		18542	
9,35	125	81	10	27556			
9,40	125	81	10	10304		27149	
9,45	125	81	10	27387			
9,50	125	81	10	10307		18545	
9,55	133	87	10	27389			
9,60	133	87	10	10310		26687	
9,65	133	87	10	27390			
9,70	133	87	10	10313		27151	
9,75	133	87	10	10316		18548	
9,80	133	87	10	10319		18551	
9,85	133	87	10	27391			
9,90	133	87	10	10322		18554	
9,95	133	87	10	27393			
10,00	133	87	10	10325		18557	
10,10	133	87	5	10328		29149	





Ref. **1010**

BROCA MANGO CILÍNDRICO HSS

HSS Straight Shank Drill Bit
Foret queue cylindrique HSS

D mm	L mm	I mm		Nº Art. HSS	€	Nº Art. TIN	€	D mm	L mm	I mm		Nº Art. HSS	€	Nº Art. TIN	€
10,20	133	87	5	10331		18560		13,80	160	108	1	18176	15,66	24664	
10,25	133	87	5	10334		27274		13,90	160	108	1	10451	15,66	68188	
10,30	133	87	5	10337		29151		14,00	160	108	1	10454	11,65	29007	
10,40	133	87	5	10340				14,10	169	114	1	18179	16,69		
10,50	133	87	5	10343		18563		14,20	169	114	1	18185	16,69		
10,60	133	87	5	10346		29154		14,25	169	114	1	10457	13,67	29194	
10,70	142	94	5	10349				14,30	169	114	1	18188	17,00		
10,75	142	94	5	10352		27277		14,40	169	114	1	18191	17,00		
10,80	142	94	5	10355		29157		14,50	169	114	1	10460	12,57	29198	
10,90	142	94	5	10358				14,60	169	114	1	18194	17,30		
11,00	142	94	5	10361		18566		14,70	169	114	1	18197	17,30		
11,10	142	94	5	10364				14,75	169	114	1	10463	13,67	29202	
11,20	142	94	5	10367				14,80	169	114	1	18200	16,69		
11,25	142	94	5	10370		26801		14,90	169	114	1	18203	16,69		
New! 11,30	142	94	5	10373		27448		15,00	169	114	1	10466	12,70	29205	
11,40	142	94	5	10376		27450		15,20	178	120	1	18209	21,90		
11,50	142	94	5	10379		18569		15,25	178	120	1	10469	18,64	29209	
11,60	142	94	5	10382				15,50	178	120	1	10472	14,86	29213	
11,70	142	94	5	10385				15,60	178	120	1	18218	25,63		
11,75	142	94	5	10388		27275		15,70	178	120	1	18221	25,63		
11,80	142	94	5	10391		29166		15,75	178	120	1	10475	18,89		
11,90	151	101	5	10394		29167		15,80	178	120	1	18224	23,92		
12,00	151	101	5	10397		18572		15,90	178	120	1	18227	23,92		
12,10	151	101	5	10400		29169		16,00	178	120	1	10478	15,47	29220	
12,20	151	101	5	10403				16,20	184	125	1	27289	32,74		
12,25	151	101	5	10406		18578		16,25	184	125	1	10481	27,84		
New! 12,30	151	101	5	10409		24144		16,50	184	125	1	10484	18,00	12861	
12,40	151	101	5	10412				16,75	184	125	1	10487	29,10	19368	
12,50	151	101	5	10415		18581		16,80	184	125	1	27676	43,98	19369	
12,60	151	101	5	10418				17,00	184	125	1	10490	18,00	12866	
12,70	151	101	5	10421				17,25	191	130	1	10493	30,21		
12,75	151	101	5	10424		27276		17,50	191	130	1	10496	20,69	12862	
12,80	151	101	5	10427				17,75	191	130	1	10499	33,45		
12,90	151	101	5	10430				18,00	191	130	1	10502	21,88	29236	
13,00	151	101	5	10433		18584		New! 18,25	198	135	1	10505	32,81		
13,10	151	101	1	10436				18,50	198	135	1	10508	24,30	10794	
13,20	151	101	1	18164				18,75	198	135	1	10511	33,74		
13,25	160	108	1	10439		29180		19,00	198	135	1	10514	24,30	14065	
13,30	160	108	1	18167				19,25	205	140	1	10517	44,16		
13,40	160	108	1	18170				19,50	205	140	1	10520	26,05		
13,50	160	108	1	10442		29184		19,75	205	140	1	10523	42,83		
13,60	160	108	1	18173				New! 20,00	205	140	1	10526	29,68	14076	
13,70	160	108	1	10445											
13,75	160	108	1	10448		16497									

Ref. **1050**



Extra-Corta / Stub / Extra-courte

Pag 81

Ref. **1030**



Larga / Long / Longue

Pag 82

Ref. **1040**



Extra Larga / Extra Long / Extra-longue Pag 86



Expo - Ref. 1010



Cuartos / Quarters / Quarts

∅	1	1,5	2	2,5	3	3,25
Pcs	30	20	40	30	80	20
∅	3,5	4	4,25	4,5	5	
Pcs	20	60	10	20	80	
∅	5,5	6	6,5	7		
Pcs	10	60	20	20		
∅	7,5	8	8,5	9		
Pcs	10	40	10	10		
∅	9,5	10	11	12	13	
Pcs	10	30	15	20	10	

Nº Art. 57523: €

Previos Roscado / Before Threading / Pré-Taraudage

∅	1	1,5	2	2,5	3	3,3
Pcs	30	20	40	30	80	20
∅	3,5	4	4,2	4,5	5	
Pcs	20	60	10	20	80	
∅	5,5	6	6,5	6,8		
Pcs	10	60	20	10		
∅	7	7,5	8	8,5		
Pcs	20	10	40	10		
∅	9	9,5	10	10,2	11	12
Pcs	10	10	30	10	15	20

Nº Art. 57975: €

Línea 1 m - Ref. 1010



Cuartos / Quarters / Quarts

1,5	3	4	5	6	7	8	9	10	12	mm Pcs
	80	60	80							
1	2,5	3,5	4,5	5,5	6,5	7,5	8,5	9,5	11	13
	30	20	20							

Nº Art. 70965: €

Previos Roscado / Before Threading / Pré-Taraudage

1,5	3	4	5	6	7	8	9,5	10,2	12	mm Pcs
	80	60	80				60			
1	2,5	3,5	4,5	5,5	6,8	7,5	9	10	11	13
	30	20	20				60			

Nº Art. 70999: €



Expo - Ref. 1010



400 Pcs

∅	1	1,5	2	2,5	3	3,5	4	4,5
Pcs	10	10	20	20	50	30	40	20
∅	5	5,5	6	6,5	7			
Pcs	40	10	30	10	10			
∅	7,5	8	8,5	9				
Pcs	10	20	10	10				
∅	9,5	10	10,5	11				
Pcs	10	10	5	5				
∅	11,5	12	12,5	13				
Pcs	5	5	5	5				

N° Art. 55440: €

Ref. **1001**

BROCA MANGO CILÍNDRICO HSS

HSS Straight Shank Drill Bit
Foret queue cylindrique HSS



CLASSIQUE



HSS	HSS + TIN	DIN 338 N			Uso General General Purpose Utilisation générale
-----	-----------	-----------	--	--	--

Aceros <850 N/mm ² Steel / Aciers	Fundición Cast Iron Fonte	Aluminio Aluminium
---	--	------------------------------

D mm	L mm	I mm		Nº Art. HSS	€	Nº Art. TIN	€
1,00	34	12	2	18781		16527	*
1,50	40	18	2	18783		16528	*
2,00	49	24	2	18792		16529	*
2,50	57	30	2	18793		16530	*
3,00	61	33	2	18687		16531	*
3,25	65	36	2	30156		16532	*
3,30	65	36	2	34039			*
3,50	70	39	2	18688		16533	*
4,00	75	43	2	18589		16534	*
4,20	75	43	1	34040			
4,25	75	43	1	30157		16535	
4,50	80	47	1	18591		16536	
5,00	86	52	1	18592		16537	
5,50	93	57	1	18594		16538	
6,00	93	57	1	18595		16539	
6,50	101	63	1	18597		16540	
6,80	109	69	1	34041			
7,00	109	69	1	18645		16541	
7,50	109	69	1	18646		16542	
8,00	117	75	1	18655		16543	
8,50	117	75	1	18657		16544	
9,00	125	81	1	18666		16545	
9,50	125	81	1	66989			
10,00	133	87	1	18667		16546	
10,20	133	87	1	34042			
10,50	133	87	1	66991			
11,00	142	94	1	30158		16547	
11,50	142	94	1	66993			
12,00	151	101	1	18676		16549	
12,50	151	101	1	66995			
13,00	151	101	1	30159		16550	



* € = 2 uds.



Línea 1 m - Ref. 1001



∅	1	1,5	2	2,5	3	3,25	3,5	4	4,25	4,5	5	5,5	6	6,5	7	7,5	8	9	10	
Packs	10	10	10	10	10	10	10	10	10	10	10	10	10	10	10	10	10	10	10	10

Ref. 4995 - Nº Art. 70942: €

Display 14 - Ref. 1001



∅	7,5	8	8,5	9	10	11	12	13		
Packs	5	5	5	5	3	3	3	3		
∅	4	4,25	4,5	5	5	5,5	6	6	6,5	7
Packs	10	10	10	10	10	5	5	5	5	5
∅	1	1,5	2	2,5	3	3	3,25	3,5	3,5	4
Packs	10	10	10	10	10	10	10	10	10	10

Ref. 4995 - Nº Art. 22162: €

Display 46 - Ref. 1001 + PREVIOS ROSCADO ✕ Before Threading + Pré-Tarudage



∅	8	8,5	9	10	10,2	11	12	13		
Packs	5	5	5	3	3	3	3	3		
∅	4,25	4,5	5	5	5,5	6	6,5	6,8	7	7,5
Packs	15	8	8	7	5	10	5	5	5	5
∅	1	1,5	2	2,5	3	3,25	3,3	3,5	4	4,2
Packs	10	10	10	10	10	10	8	10	10	8

Ref. 4995 - Nº Art. 55618: €

Display 51 - Refs. 1880 - 1640 - 1001

BROCAS METAL + PARED + MADERA

Metal + Masonry + Wood Drill Bits
Forets Métal + Maçonnerie + Bois



Ref. 1880	∅	3	4	5	6	7	8	9	10	12	14
	Pcs	10	10	10	10	10	10	5	5	5	5
Ref. 1640	∅	3	4	5	6	8	9	10	12	14	16
	Pcs	10	10	10	10	10	5	5	5	5	5
Ref. 1001	∅	1	2	3	3,5	4	4,5	5	6	8	10
	Pcs	10	10	10	10	10	10	10	5	5	3

Ref. 4995 - N° Art. 68572: €

Display 24 - Refs. 1016 - 1010

SETS BROCAS MANGO CILINDRICO HSS + HSSE

HSS + HSSE Straight Shank Drill Bit Sets
Jeux forets queue cylindrique HSS + HSSE



HSSE	Set 1462 - Ref. 1016 Metal Pro 5 Pcs.	Set 1466 - Ref. 1016 Metal Pro 19 Pcs.	Set 1456 - Ref. 1016 Metal Pro 25 Pcs.
	Pcs 5	Pcs 1	Pcs 1
HSS	Set 1462 - Ref. 1010 Metal 5 Pcs.	Set 1466 - Ref. 1010 Metal 19 Pcs.	Set 1456 - Ref. 1010 Metal 25 Pcs.
	Pcs 5	Pcs 2	Pcs 2

Ref. 4995 - N° Art. 22320: €

Línea 33 cm - 14S1

SETS BROCAS METAL, PARED PRO, PARED, MADERA

Metal, Concrete, Masonry, Wood Sets
Jeux Métal, Béton, Maçonnerie, Bois



	Metal Metal Métal	Pared Pro Concrete Béton	Pared Masonry Maçonnerie	Madera Wood Bois
Ref	Set 1462 - Ref. 1010	Set 1486 - Ref. 1886	Set 1485 - Ref. 1880	Set 1435 - Ref. 1640
Diam	2-3-4-5-6-8 mm	4-5-6-8-10 mm	4-5-6-8-10 mm	4-5-6-8-10 mm
Pcs.	5	5	5	5

Ref. 4995 - N° Art. 72193: €





Set **1462**
6 Pcs

Cont. Ø	Nº Art.	€
2 - 3 - 4 - 5 - 6 - 8 mm	30230	



New!

Set **1459**
29 Pcs

Cont. Ø	Nº Art.	€
1 - 13 x 0,5 mm *	15070	

* + Previos Roscado / Before Threading
Pré-Taraudage (3,3 - 4,2 - 6,8 - 10,2 mm)



Set **1466**
19 Pcs

Cont. Ø	Nº Art.	€
1 - 10 x 0,5 mm	25271	

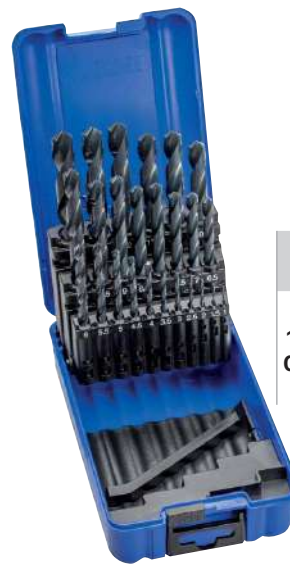

Set **1456**
25 Pcs

Cont. Ø	Nº Art.	€
1 - 13 x 0,5 mm	25235	



Box-Pallet
1010
5 Sets 1466

Cont. Set	Nº Art.	€
1 - 10 x 0,5 mm	79644	



Box-Pallet
1010
5 Sets 1456

Cont. Set	Nº Art.	€
1 - 13 x 0,5 mm	80671	

Set 1407



37 Pcs

Cont. Ø	N° Art.	€
1 - 10 × 0,25 mm	26768	

Set 1409



49 Pcs

Cont. Ø	N° Art.	€
1 - 13 × 0,25 mm	26802	

Set 1405



50 Pcs

Cont. Ø	N° Art.	€
1 - 5,9 × 0,1 mm	26765	

Set 1408



41 Pcs

Cont. Ø	N° Art.	€
6 - 10 × 0,1 mm	26771	

Set 1406

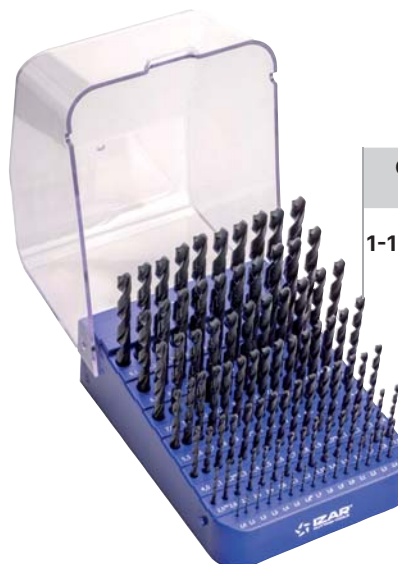

91 Pcs

Cont. Ø	N° Art.	€
1-10 × 0,10 mm	56685	

New!

Set 1404

99 Pcs



Cont. Ø	N° Art.	€
1-10x0,1mm + 10-13x0,5mm *	48815	

* + Previos Roscado / Before Threading
Pré-Taroudage (10-13 mm)





Set **1410** **NOVABOX**

Mida y ubique las brocas en un solo movimiento
Gauge and place the drills in one single movement
 Mesurer et classer les forets en une seule course

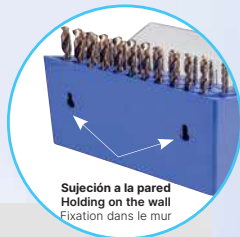

- Almacene y trabaje con este juego de 55 brocas para metal
- Manejo fácil para colocar las brocas en los huecos correspondientes
- Posibilidad de colgar en la pared gracias al colgador trasero
- Storage and management in a 55 metalworking drill set
- Easy use to put drills in suitable socket
- Possibility to hang on the wall
- Stockez et travaillez avec ce jeu de 55 forets
- Utilisation facile pour ranger les forets dans le trou correspondant
- Possibilité d'accrocher au mur grâce au crochet arrière



Agujeros para:

- Brocas desde 1 a 13 mm x 0,5 mm
- Incluye los siguientes diámetros previos al roscado:
 ø2,5 / 3,3 / 4,2 / 5,0 / 6,8 / 8,5 / 10,2 / 12,0 mm
 para las métricas de roscado
 M3 / M4 / M5 / M6 / M8 / M10 / M12 / M14

Holes for:

- Drill diameters from 1 to 13 mm x 0,5 mm
- Includes core hole sizes:
 ø2,5 / 3,3 / 4,2 / 5,0 / 6,8 / 8,5 / 10,2 / 12,0 mm for
 threading dimensions
 M3 / M4 / M5 / M6 / M8 / M10 / M12 / M14

Trous pour:

- Forets de 1 à 13 mm x 0,5 mm
- Inclut les diamètres suivantes pré-taraudage:
 ø2,5 / 3,3 / 4,2 / 5,0 / 6,8 / 8,5 / 10,2 / 12,0 mm
 pour les métriques de taraudage
 M3 / M4 / M5 / M6 / M8 / M10 / M12 / M14

New!



55 Pcs

Cont. Ø	Nº Art.	€
1 - 13 x 0,5 mm		
Ø1,0 - 4,0 mm: 3 pcs	19535	
Ø4,2 - 8,0 mm: 2 pcs		
Ø8,50 - 13,0 mm: 1 pcs		

Sets **1470**

170 Pcs



Cont. Ø	Nº Art.	€
1-10 x 0,5 mm		
ø 1-8: 10 pcs/ø	19590	
ø 8,5-10: 5 pcs/ø		

220 Pcs



Cont. Ø	Nº Art.	€
1-13 x 0,5 + 3,3 + 4,2 mm		
ø 1-8: 10 pcs/ø	56676	
ø 8,5-13: 5 pcs/ø		



Sets - Ref. 1010 HSS+TIN

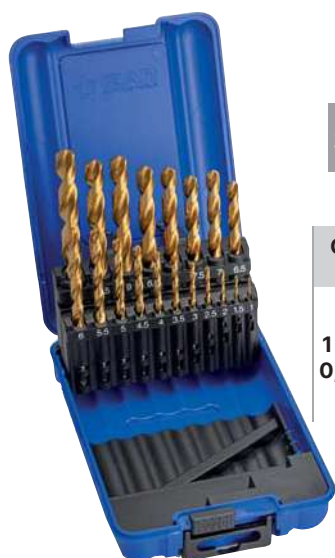

Set **1466**

19 Pcs

Cont. Ø	Nº Art. TIN	€
1 - 10 x 0,5 mm	27132	



Set **1456**

25 Pcs

Cont. Ø	Nº Art. TIN	€
1 - 13 x 0,5 mm	27133	

Set **1407**



37 Pcs

Cont. Ø	Nº Art. TIN	€
1 - 10 x 0,25 mm	27134	

Set **1409**



49 Pcs

Cont. Ø	Nº Art. TIN	€
1 - 13 x 0,25 mm	27135	

Set **1405**



50 Pcs

Cont. Ø	Nº Art. TIN	€
1 - 5,9 x 0,1 mm	13154	

Set **1408**



41 Pcs

Cont. Ø	Nº Art. TIN	€
6 - 10 x 0,1 mm	13152	



Ref. **1013**

BROCA MANGO CILÍNDRICO HSS SPEED POINT

Speed Point HSS Straight Shank Drill Bit
Foret queue cylindrique HSS Speed Point



SPEED POINT



x 3,5

TIALSIN

Resistencia al desgaste
Wear Resistance
Haute résistance à l'usure

HSS	HSS + TIALSIN	DIN 338 N			Chapa Sheets Tôle < 5 mm
-----	---------------	-----------	--	--	--------------------------

Aceros <850 N/mm ² Steel / Aciers	Fundición Cast Iron Fonte	Aluminio Aluminium
--	---------------------------	--------------------

D mm	L mm	I mm		Nº Art. HSS	€	Nº Art. TIALSIN	€	D mm	L mm	I mm		Nº Art. HSS	€	Nº Art. TIALSIN	€
1,00	34	12	10	17673		37620		4,25	75	43	10	10777			
1,10	36	14	10	10650				4,30	80	47	10	10779			
1,20	38	16	10	10656				4,40	80	47	10	10780			
1,30	38	16	10	10662				4,50	80	47	10	10782		37627	
1,40	40	18	10	10663				4,60	80	47	10	10783			
1,50	40	18	10	10666		37621		4,70	80	47	10	10786		69082	
1,60	43	20	10	10669				4,75	80	47	10	10787			
1,70	43	20	10	10670				4,80	86	52	10	10789		39240	
1,75	46	22	10	10671				4,90	86	52	10	10792			
1,80	46	22	10	10672				5,00	86	52	10	10793		17442	
1,90	46	22	10	10674				5,10	86	52	10	10795			
2,00	49	24	10	10675		37497		5,20	86	52	10	10797		39242	
2,10	49	24	10	10677				5,25	86	52	10	10798			
2,20	53	27	10	13596				5,30	86	52	10	10799		45421	
2,25	53	27	10	10679				5,40	93	57	10	10800			
2,30	53	27	10	13608				5,50	93	57	10	10801		37628	
2,40	57	30	10	10683				5,60	93	57	10	10802			
2,50	57	30	10	10684		37622		5,70	93	57	10	10804		39244	
2,60	57	30	10	10685				5,75	93	57	10	10807			
2,70	61	33	10	10686				5,80	93	57	10	10808			
2,75	61	33	10	10687				5,90	93	57	10	10810			
2,80	61	33	10	10690				6,00	93	57	10	10811		32677	
2,90	61	33	10	10692				6,10	101	63	10	10813			
3,00	61	33	10	10693		37623		6,20	101	63	10	10814		39246	
3,10	65	36	10	10695				6,25	101	63	10	10815			
3,20	65	36	10	10696		32571		6,30	101	63	10	10816			
3,25	65	36	10	10698				6,40	101	63	10	10819			
3,30	65	36	10	10699		37624		6,50	101	63	10	10822		36558	
3,40	70	39	10	10701				6,60	101	63	10	11145			
3,50	70	39	10	10702		37625		6,70	101	63	10	11154		45424	
3,60	70	39	10	10704				6,75	109	69	10	11157		66924	
3,70	70	39	10	10705				6,80	109	69	10	11163		37629	
3,75	70	39	10	10708				6,90	109	69	10	11166		45725	
3,80	75	43	10	10710		39236		7,00	109	69	10	11172		36559	
3,90	75	43	10	10719				7,10	109	69	10	11175			
4,00	75	43	10	10770		32572		7,20	109	69	10	13066			
4,10	75	43	10	10774				7,25	109	69	10	11184			
4,20	75	43	10	10776		36557		7,30	109	69	10	11190			





Ref. **1013**

BROCA MANGO CILÍNDRICO HSS SPEED POINT

Speed Point HSS Straight Shank Drill Bit
Foret queue cylindrique HSS Speed Point



D mm	L mm	I mm		Nº Art. HSS	€	Nº Art. TIALSIN	€	D mm	L mm	I mm		Nº Art. HSS	€	Nº Art. TIALSIN	€
7,40	109	69	10	11202				10,90	142	94	5	17975			
7,50	109	69	10	11217		37630		11,00	142	94	5	13783		37635	
7,60	117	75	10	14362				11,10	142	94	5	17978			
7,70	117	75	10	11226				11,20	142	94	5	66583			
7,75	117	75	10	11229				New! 11,25	142	94	5	53636			
7,80	117	75	10	11230				11,30	142	94	5	17980			
7,90	117	75	10	11251				11,40	142	94	5	17981			
8,00	117	75	10	11268		36560		11,50	142	94	5	17609		37636	
8,10	117	75	5	11269				11,60	142	94	5	17982			
8,20	117	75	5	11287		64063		11,70	142	94	5	19657			
8,25	117	75	5	11290				11,80	142	94	5	17984			
8,30	117	75	5	11297				11,90	151	101	5	17987			
8,40	117	75	5	11302				12,00	151	101	5	17611		37637	
8,50	117	75	5	11303		37498		12,10	151	101	5	63357			
8,60	125	81	5	11304				12,20	151	101	5	63358			
8,70	125	81	5	11305				New! 12,25	151	101	5	53639			
8,75	125	81	5	11306				12,30	151	101	5	22343			
8,80	125	81	5	11307				12,40	151	101	5	63360			
8,90	125	81	5	11308				12,50	151	101	5	17615		37638	
9,00	125	81	5	11310		37631		12,60	151	101	5	63361			
9,10	125	81	5	14378		39252		12,70	151	101	5	17081			
9,20	125	81	5	14304		64064		New! 12,75	151	101	5	53645			
9,25	125	81	5	11313				12,80	151	101	5	63363			
9,30	125	81	5	14305				12,90	151	101	5	63364			
9,40	125	81	5	13007				13,00	151	101	5	16556		36556	
9,50	125	81	5	11317		37632		New! 13,20	151	101	1	82665			
9,60	133	87	5	11318				13,50	160	108	1	22833		83459	
9,70	133	87	5	13440				14,00	160	108	1	19224		64065	
9,75	133	87	5	11321				14,50	169	114	1	24941			
9,80	133	87	5	11322				New! 15,00	169	114	1	19227		12770	
9,90	133	87	5	11323				New! 15,25	178	120	1	25973			
10,00	133	87	5	11324		36147		15,50	178	120	1	51929			
10,10	133	87	5	22341				New! 16,00	178	120	1	22306		12771	
10,20	133	87	5	17648		37633		16,50	184	125	1	51640			
New! 10,25	133	87	5	53630				New! 17,00	184	125	1	48580		12784	
10,30	133	87	5	17506		37634		17,50	191	130	1	48582			
10,40	133	87	5	17966				New! 18,00	191	130	1	48583		12792	
10,50	133	87	5	17613		38088		18,50	198	135	1	48585			
10,60	133	87	5	17969				New! 19,00	198	135	1	48586		12793	
10,70	142	94	5	22342				19,50	205	140	1	48588			
New! 10,75	142	94	5	53633				New! 20,00	205	140	1	48589		12794	
10,80	142	94	5	17972											



Expo - Ref. 1013



Cuartos / Quarters / Quarts

∅	1	1,5	2	2,5	3	3,25
Pcs	30	20	40	30	50	30
∅	3,5	4	4,25	4,5	5	
Pcs	30	50	30	30	50	
∅	5,5	6	6,5	7		
Pcs	40	50	20	20		
∅	7,5	8	8,5	9		
Pcs	20	40	20	20		
∅	9,5	10	11	12	13	
Pcs	5	20	5	10	5	

Nº Art. 57524: €

Previos Roscado / Before Threading / Pré-Taraudage

∅	1	1,5	2	2,5	3	3,3
Pcs	30	20	40	30	50	30
∅	3,5	4	4,2	4,5	5	
Pcs	30	50	30	30	50	
∅	5,5	6	6,5	6,8		
Pcs	40	50	20	10		
∅	7	7,5	8	8,5		
Pcs	20	20	40	20		
∅	9	9,5	10	10,2	11	12
Pcs	20	5	20	5	5	10
						13
						5

Nº Art. 57976: €

Línea 1 m - Ref. 1013

Cuartos / Quarters / Quarts

1,5 20	3	4	5	6 50	7 20	8 40	9 20	10 20	12 10	mm pcs
	2,5	3,5	4,5							
1 30	2	3,25	4,25	5,5 40	6,5 20	7,5 20	8,5 20	9,5 5	11 5	13 5
	4	3	5							

Nº Art. 71057: €

Previos Roscado / Before Threading / Pré-Taraudage

1,5 30	3	4	5	6 50	7 20	8 40	9,5 5	10,2 5	12 10	mm pcs
	2,5	3,5	4,5							
1 20	2	3,3	4,2	5,5 40	6,8 10	7,5 20	9 20	10 20	11 5	13 5
	4	3	5							

Nº Art. 71390: €





Expo - Ref. 1013



350 Pcs

∅	1	1,5	2	2,5	3	3,5	4	4,5
Pcs	10	10	20	20	40	20	40	20
∅	5		5,5		6		6,5	
Pcs	30		10		30		10	
∅	7,5		8		8,5		9	
Pcs	10		20		5		5	
∅	9,5		10		10,5		11	
Pcs	5		5		5		5	
∅	11,5		12		12,5		13	
Pcs	5		5		5		5	

N° Art. 55443:

€



Ref. **1002**

BROCA MANGO CILÍNDRICO HSS SPEED POINT

Speed Point HSS Straight Shank Drill Bit
Foret queue cylindrique HSS Speed Point



SPEED POINT



Aceros
<850 N/mm²
Steel / Aciers

Fundición
Cast Iron
Fonte

Aluminio
Aluminium

D mm	L mm	I mm		Nº Art.	€
1,00	34	12	2	24778	*
1,50	40	18	2	16516	*
2,00	49	24	2	24779	*
2,50	57	30	2	24780	*
3,00	61	33	2	24781	*
3,25	65	36	2	24782	*
3,30	65	36	2	39913	*
3,50	70	39	2	24783	*
3,80	75	43	2	79610	*
4,00	75	43	2	24784	*
4,20	75	43	1	39914	
4,25	75	43	1	24785	
4,50	80	47	1	24786	
4,80	86	52	1	79611	
5,00	86	52	1	24787	
5,20	86	52	1	73529	
5,50	93	57	1	24788	
5,80	93	57	1	79612	
6,00	93	57	1	24789	
6,50	101	63	1	24790	
6,80	109	69	1	39915	
7,00	109	69	1	24791	
7,50	109	69	1	24792	
8,00	117	75	1	24793	
8,50	117	75	1	24794	
9,00	125	81	1	24795	
9,50	125	81	1	74946	
10,00	133	87	1	24796	
10,20	133	87	1	39916	
10,50	133	87	1	74949	
11,00	142	94	1	24797	
11,50	142	94	1	74950	
12,00	151	101	1	24798	
12,50	151	101	1	79613	
13,00	151	101	1	24799	
14,00	160	108	1	79614	



* € = 2 uds.





Línea 1 m - Ref. 1002



∅	1	1,5	2	2,5	3	3,25	3,5	4	4,25	4,5	5	5,5	6	6,5	7	7,5	8	9	10	
Packs	10	10	10	10	10	10	10	10	10	10	10	10	10	10	10	10	10	10	10	10

Ref. 4995 - Nº Art. 70947: €

Display 17 - Ref. 1002



∅	7,5	8	8,5	9	10	11	12	13		
Packs	8	8	5	5	3	3	3	3		
∅	4	4,25	4,5	5	5	5,5	6	6	6,5	7
Packs	5	10	10	5	5	10	5	5	10	8
∅	1	1,5	2	2,5	3	3	3,25	3,5	3,5	4
Packs	10	10	10	10	5	5	10	5	5	5

Ref. 4995 - Nº Art. 22492: €



Display 47 - Ref. 1002 + PREVIOS ROSCADO + Before Threading Ж Прэ-Тараудаже



∅	8	8,5	9	10	10,2	11	12	13		
Pcs	5	5	5	3	3	3	3	3	3	
∅	4,25	4,5	5	5	5,5	6	6,5	6,8	7	7,5
Pcs	10	5	5	5	5	10	5	5	5	5
∅	1	1,5	2	2,5	3	3,25	3,3	3,5	4	4,2
Pcs	10	10	10	5	10	10	5	10	10	5

Ref. 4995 - N° Art. 55620: €

Display 59 - Refs. 1880 - 1640 - 1002

BROCAS SPEED POINT + PARED + MADERA

Speed Point + Masonry + Wood Drill Bits

Forets Speed Point + Maçonnerie + Bois



Ref. 1880	∅	3	4	5	6	7	8	9	10	12	14
	Pcs	10	10	10	10	10	10	5	5	5	5
Ref. 1640	∅	3	4	5	6	8	9	10	12	14	16
	Pcs	10	10	10	10	10	5	5	5	5	5
Ref. 1002	∅	2	3	3,5	4	4,5	5	6	7	8	10
	Pcs	10	10	10	10	10	10	5	5	5	3

Ref. 4995 - N° Art. 70099: €



Set 1462

6 Pcs

Cont. Ø	Nº Art.	€
2 - 3 - 4 - 5 - 6 - 8 mm	25365	



New!

Set 1459

29 Pcs

Cont. Ø	Nº Art.	€
1 - 13 x 0,5 mm *	15088	

* + Previos Roscado / Before Threading
Pré-Taroudage (3,3 - 4,2 - 6,8 - 10,2 mm)

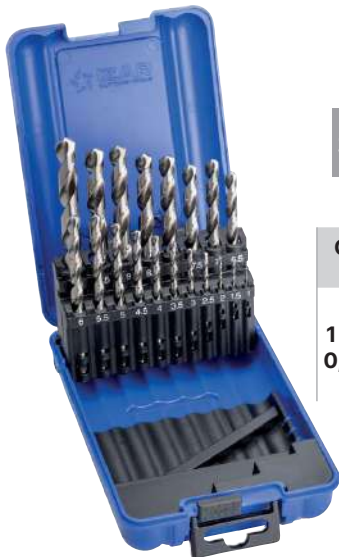

Set 1466

19 Pcs

Cont. Ø	Nº Art.	€
1 - 10 x 0,5 mm	18808	



Set 1456

25 Pcs

Cont. Ø	Nº Art.	€
1 - 13 x 0,5 mm	18807	



Box-Pallet
1013

5 Sets 1466

Cont. Set	Nº Art.	€
1 - 10 x 0,5 mm	80659	



Box-Pallet
1013

5 Sets 1456

Cont. Set	Nº Art.	€
1 - 13 x 0,5 mm	80675	





Set **1406**
91 Pcs

Cont. Ø	Nº Art.	€
1-10 x 0,10 mm	60624	

New! Set **1404**
99 Pcs

Cont. Ø	Nº Art.	€
1-10x0,1mm + 10-13x0,5mm *	48818	

* + Previos Roscado / Before Threading
 Pré-Taraudage (10-13 mm)

Set **1410** **NOVABOX**
New!

55 Pcs

Cont. Ø	Nº Art.	€
1 - 13 x 0,5 mm Ø1,0 - 4,0 mm: 3 pcs Ø4,2 - 8,0 mm: 2 pcs Ø8,50 - 13,0 mm: 1 pcs	19536	

Sets **1470**
170 Pcs

Cont. Ø	Nº Art.	€
1-10 x 0,5 mm Ø 1-8: 10 pcs/Ø Ø 8,5-10: 5 pcs/Ø	56677	

220 Pcs

Cont. Ø	Nº Art.	€
1-13 x 0,5 + 3,3 + 4,2 mm Ø 1-8: 10 pcs/Ø Ø 8,5-13: 5 pcs/Ø	56679	





Sets - Ref. 1013



TIALSIN Set **1466**

19 Pcs

Cont. Ø	N° Art. TIALSIN	€
1 - 10 x 0,5 mm	38833	

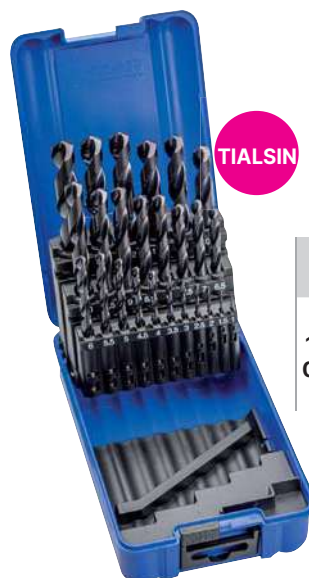

TIALSIN Set **1456**

25 Pcs

Cont. Ø	N° Art. TIALSIN	€
1 - 13 x 0,5 mm	38832	



Ref. **1007**

BROCA MANGO REBAJADO HSS

HSS Reduced Shank Drill Bit
Foret queue reduite HSS



Aceros
<850 N/mm²
Steel / Aciers

Fundición
Cast Iron
Fonte

Aluminio
Aluminium

D mm	d mm	L mm	l mm		Nº Art.	€
10,50	10,00	133	87	1	15976	
11,00	10,00	142	94	1	15977	
11,50	10,00	142	94	1	15978	
12,00	10,00	151	101	1	15979	
12,50	10,00	151	101	1	15980	
13,00	10,00	151	101	1	15981	
13,50	12,70	160	108	1	15982	
14,00	12,70	160	108	1	15984	
14,50	12,70	169	114	1	15985	
15,00	12,70	169	114	1	15987	
15,50	12,70	178	120	1	15988	
16,00	12,70	178	120	1	15989	
16,50	12,70	184	125	1	15990	
17,00	12,70	184	125	1	15991	
17,50	12,70	191	130	1	15992	

D mm	d mm	L mm	l mm		Nº Art.	€
18,00	12,70	191	130	1	15993	
18,50	12,70	198	135	1	15994	
19,00	12,70	198	135	1	15995	
19,50	12,70	205	140	1	15996	
20,00	12,70	205	140	1	15997	
20,50	12,70	205	145	1	66932	
21,00	12,70	205	145	1	17071	
21,50	12,70	210	150	1	66933	
22,00	12,70	210	150	1	17072	
22,50	12,70	210	150	1	66934	
23,00	12,70	210	150	1	36364	
23,50	12,70	220	160	1	66935	
24,00	12,70	220	160	1	36365	
24,50	12,70	220	160	1	66936	
25,00	12,70	220	160	1	36366	



Línea 1 m - Ref. 1007



∅	12	12,5	13	13,5	14	15	15,5	16	16,5	17	17,5	18	18,5	19	19,5	20
Pcs	2	2	2	2	2	2	2	2	2	2	2	2	2	2	2	2

Ref. 4995 - Nº Art. 70951: €

Display 18 - Ref. 1007



∅	17	17,5	18	18	18,5	19	19,5	20
Pcs	2	2	1	1	1	1	1	1
∅	14	14	14,5	15	15,5	16	16	16,5
Pcs	2	1	2	2	2	1	1	2
∅	10,5	11	11,5	12	12	12,5	13	13,5
Pcs	2	2	2	2	1	2	2	2

Ref. 4995 - Nº Art. 22352: €



Ref. **1012**

BROCA MANGO CILÍNDRICO HSS

HSS Straight Shank Drill Bit
Foret queue cylindrique HSS



D mm	L mm	I mm		Nº Art.	€	D mm	L mm	I mm		Nº Art.	€
1,00	34	12	10	10586		7,50	109	69	10	10625	
1,25	38	16	10	27590		7,75	117	75	10	19022	
1,50	40	18	10	10589		8,00	117	75	10	10628	
2,00	49	24	10	10592		8,25	117	75	10	19031	
2,25	53	27	10	18908		8,50	117	75	10	10631	
2,50	57	30	10	10595		9,00	125	81	10	10634	
2,75	61	33	10	18917		9,50	125	81	10	10637	
3,00	61	33	10	10598		9,75	133	87	10	19040	
3,25	65	36	10	18932		10,00	133	87	10	10640	
3,50	70	39	10	10601		10,50	133	87	5	10643	
*3,75	70	39	10	18941		11,00	142	94	5	10646	
4,00	75	43	10	10604		11,50	142	94	5	10649	
4,25	75	43	10	18953		12,00	151	101	5	10652	
4,50	80	47	10	10607		12,50	151	101	5	10655	
4,75	80	47	10	18968		13,00	151	101	5	10658	
5,00	86	52	10	10610		14,00	160	108	1	18863	
5,20	86	52	10	18974		14,50	169	114	1	46846	
5,25	86	52	10	18977		15,00	169	114	1	54158	
5,50	93	57	10	10613		16,00	178	120	1	46847	
*5,75	93	57	10	18980		16,50	184	125	1	46848	
6,00	93	57	10	10616		17,00	184	125	1	46849	
6,25	101	63	10	18986		18,00	191	130	1	54159	
6,50	101	63	10	10619		18,50	198	135	1	46851	
6,75	109	69	10	18998		19,00	198	135	1	46852	
7,00	109	69	10	10622		20,00	205	140	1	46850	
7,25	109	69	10	19013							



* Diam. hasta fin de existencias / while stock lasts / jusqu'à la fin de stock



Ref. **1025**

BROCA MANGO CILÍNDRICO CORTE IZQUIERDA

Left Hand Straight Shank Drill Bit

Foret queue cylindrique coupe à gauche



Aceros
 <850 N/mm²
 Steel / Aciers

Fundición
 Cast Iron
 Fonte

Aluminio
 Aluminium

D mm	L mm	I mm		Nº Art.	€
1,00	34	12	10	10554	
1,50	40	18	10	10560	
2,00	49	24	10	10562	
2,50	57	30	10	10564	
3,00	61	33	10	10569	
3,50	70	39	10	11121	
4,00	75	43	10	11566	
4,50	80	47	10	11811	
5,00	86	52	10	11817	
5,50	93	57	10	11820	
6,00	93	57	10	12001	

D mm	L mm	I mm		Nº Art.	€
6,50	101	63	10	12330	
7,00	109	69	10	12336	
7,50	109	69	10	12339	
8,00	117	75	10	12345	
8,50	117	75	10	12348	
9,00	125	81	10	12399	
9,50	125	81	10	12408	
10,00	133	87	10	12417	
11,00	142	94	5	70015	
12,00	151	101	5	70016	
13,00	151	101	5	70017	



Sets - Ref. 1025



Set **1462**

6 Pcs

Cont. Ø	Nº Art.	€
2 - 3 - 4 - 5 - 6 - 8 mm	67380	



Set **1466**

19 Pcs

Cont. Ø	Nº Art.	€
1 - 10 x 0,5 mm	66659	



Ref. **1660**

BROCA MANGO CILÍNDRICO HSS DOBLE

Double HSS Straight Shank Drill Bit
Foret queue cylindrique HSS double



Aceros
<850 N/mm²
Steel / Aciers

D mm	L mm	I mm		Nº Art.	€	D mm	L mm	I mm		Nº Art.	€
2,00	38	9	10	16028		4,25	58	16	10	16085	
2,20	40	9	10	27607		4,50	58	16	10	16088	
New! 2,25	43	10	10	16031		4,75	62	18	10	16094	
2,30	43	10	10	25604		4,80	62	18	10	16097	
New! 2,40	43	10	10	25607		4,90	62	18	10	16100	
2,50	43	10	10	16034		5,00	62	18	10	16103	
New! 2,75	46	13	10	16037		5,10	66	19	10	16106	
2,80	46	13	10	16040		5,20	66	19	10	16109	
2,90	46	13	10	16043		5,25	66	19	10	16112	
3,00	46	13	10	16046		5,50	66	19	10	16115	
3,10	52	14	10	16049		5,70	66	19	10	25634	
3,20	52	14	10	16052		5,75	66	19	10	16121	
3,25	52	14	10	16055		6,00	66	19	10	16127	
3,30	52	14	10	16058		New! 6,10	70	21	10	25640	
3,40	52	14	10	16061		New! 6,20	70	21	10	25643	
3,50	52	14	10	16064		6,50	70	21	10	16133	
3,70	55	15	10	16067		7,00	74	24	10	16136	
3,75	55	15	10	16070		7,40	74	24	10	25664	
3,80	55	15	10	16073		7,50	74	24	10	16139	
4,00	55	15	10	16076		8,00	79	25	10	16142	
4,10	58	16	10	16079		9,00	84	25	10	16148	
4,20	58	16	10	16082		10,00	89	27	10	16154	



Ref. **1052** New!

BROCA MANGO CILÍNDRICO HSS ZIRKONIO. SERIE EXTRA CORTA

HSS Zirkonio Straight Shank Drill Bit. Stub Series

Foret queue cylindrique HSS Zirkonio. Série extra-courte

Ref. **1052**

BROCA MANGO CILÍNDRICO HSS ZIRKONIO. SERIE EXTRA CORTA

HSS Zirkonio Straight Shank Drill Bit. Stub Series

Foret queue cylindrique HSS Zirkonio. Série extra-courte

New!



ZIRKONIO

HSS	Zirkonio	DIN 1897 N	135°	DIN 1412 C ≥ 2 mm				Rectificado Ground Taillé meulé	Toi. D h8
-----	----------	------------	------	----------------------	--	--	--	---------------------------------------	--------------

Aceros <850 N/mm ² Steel / Aciers	Fundición Cast Iron Fonte	Aluminio Aluminium
---	--	------------------------------



D mm	L mm	I mm		N° Art.	€	D mm	L mm	I mm		N° Art.	€	D mm	L mm	I mm		N° Art.	€
1,00	26	6	10	44999		5,00	62	26	10	25064		9,10	84	40	10	45386	
1,10	28	7	10	48470		5,10	62	26	10	45212		9,20	84	40	10	48563	
1,20	30	8	10	48476		5,20	62	26	10	25066		9,25	84	40	10	45545	
1,25	30	8	10	45458		5,25	62	26	10	45512		9,30	84	40	10	48566	
1,30	30	8	10	48479		5,30	62	26	10	45218		9,40	84	40	10	48569	
1,40	32	9	10	48482		5,40	66	28	10	45221		9,50	84	40	10	25132	
1,50	32	9	10	45002		5,50	66	28	10	25072		9,60	89	43	10	48572	
1,60	34	10	10	45005		5,60	66	28	10	45224		9,70	89	43	10	48575	
1,70	34	10	10	48488		5,70	66	28	10	45227		9,75	89	43	10	45548	
1,75	36	11	10	45464		5,75	66	28	10	45515		9,80	89	43	10	48578	
1,80	36	11	10	45026		5,80	66	28	10	45230		9,90	89	43	10	48581	
1,90	36	11	10	45028		5,90	66	28	10	45341		10,00	89	43	10	25135	
2,00	38	12	10	24853		6,00	66	28	10	25075		10,10	89	43	1	48584	
2,10	40	13	10	45065		6,10	70	31	10	45353		10,20	89	43	1	25137	
2,20	40	13	10	45068		6,20	70	31	10	45356		10,25	89	43	1	45551	
2,25	40	13	10	48785		6,25	70	31	10	45524		10,30	89	43	1	48587	
2,30	40	13	10	45071		6,30	70	31	10	45359		10,50	89	43	1	25138	
2,40	43	14	10	45074		6,40	70	31	10	45362		10,80	95	47	1	48590	
2,50	43	14	10	24898		6,50	70	31	10	25078		11,00	95	47	1	25139	
2,60	43	14	10	24899		6,60	70	31	10	45365		11,10	95	47	1	48788	
2,70	46	16	10	45078		6,70	70	31	10	45368		11,20	95	47	1	48593	
2,75	46	16	10	45470		6,75	74	34	10	45527		11,25	95	47	1	45557	
2,80	46	16	10	45080		6,80	74	34	10	25081		11,50	95	47	1	45389	
2,90	46	16	10	45083		6,90	74	34	10	48494		11,80	95	47	1	48602	
3,00	46	16	10	24900		7,00	74	34	10	25085		12,00	102	51	1	25141	
3,10	49	18	10	45128		7,10	74	34	10	48497		12,10	102	51	1	48605	
3,20	49	18	10	24901		7,20	74	34	10	45374		12,20	102	51	1	48608	
3,25	49	18	10	24902		7,25	74	34	10	45530		12,25	102	51	1	45560	
3,30	49	18	10	24903		7,30	74	34	10	48503		12,50	102	51	1	25142	
3,40	52	20	10	45134		7,40	74	34	10	45377		12,70	102	51	1	45563	
3,50	52	20	10	24905		7,50	74	34	10	25091		13,00	102	51	1	25143	
3,60	52	20	10	45153		7,60	79	37	10	48506		13,50	107	54	1	45392	
3,70	52	20	10	45154		7,70	79	37	10	48533		14,00	107	54	1	45398	
3,75	52	20	10	45473		7,75	79	37	10	45536		14,50	111	56	1	45419	
3,80	55	22	10	45163		7,80	79	37	10	45380		15,00	111	56	1	45422	
3,90	55	22	10	45165		7,90	79	37	10	48539		15,25	115	58	1	48800	
4,00	55	22	10	24906		8,00	79	37	10	25102		15,50	115	58	1	45425	
4,10	55	22	10	24913		8,10	79	37	10	48542		15,75	115	58	1	48791	
4,20	55	22	10	24943		8,20	79	37	10	48548		16,00	115	58	1	45428	
4,25	55	22	10	45491		8,25	79	37	10	45539		16,50	119	60	1	45572	
4,30	58	24	10	25027		8,30	79	37	10	48551		17,00	119	60	1	45575	
4,40	58	24	10	45197		8,40	79	37	10	48554		17,50	123	62	1	45577	
4,50	58	24	10	25028		8,50	79	37	10	25106		18,00	123	62	1	45578	
4,60	58	24	10	45200		8,70	84	40	10	45383		18,50	127	64	1	45585	
4,70	58	24	10	45203		8,75	84	40	10	45542		19,00	127	64	1	45588	
4,75	58	24	10	45500		8,80	84	40	10	48557		19,50	131	66	1	45597	
4,80	62	26	10	45206		8,90	84	40	10	48560		20,00	131	66	1	45614	
4,90	62	26	10	25061		9,00	84	40	10	25130							



Ref. **1050**

BROCA MANGO CILÍNDRICO HSS EXTRA CORTA

HSS Straight Shank Stub Drill Bit
Foret queue cylindrique HSS extra-courte



HSS	DIN 1897 N				Serie Extra Corta Stub Series Série extra-courte	Aceros <850 N/mm ² Steel / Aciers	Fundición Cast Iron Fonte	Aluminio Aluminium
-----	------------	--	--	--	--	--	---------------------------------	-----------------------

D	L	I	N°	€	D	L	I	N°	€	D	L	I	N°	€
mm	mm	mm	Art.		mm	mm	mm	Art.		mm	mm	mm	Art.	
1,00	26	6	10 20606		5,80	66	28	10 12452		11,10	95	47	1 30593	
New! 1,10	28	7	10 48338		5,90	66	28	10 12455		New! 11,20	95	47	1 48437	
New! 1,20	30	8	10 48341		6,00	66	28	10 12458		11,25	95	47	1 12515	
1,25	30	8	10 20615		6,10	70	31	10 20651		11,50	95	47	1 12518	
New! 1,30	30	8	10 48344		6,20	70	31	10 20654		New! 11,80	95	47	1 48449	
New! 1,40	32	9	10 48347		6,25	70	31	10 12461		12,00	102	51	1 12527	
1,50	32	9	10 12302		6,30	70	31	10 20657		New! 12,10	102	51	1 48452	
1,60	34	10	10 12305		6,40	70	31	10 20663		New! 12,20	102	51	1 48455	
New! 1,70	34	10	10 48350		6,50	70	31	10 12464		12,25	102	51	1 12530	
1,75	36	11	10 12311		6,60	70	31	10 20666		12,50	102	51	1 12533	
1,80	36	11	10 12314		6,70	70	31	10 20669		12,70	102	51	1 20813	
1,90	36	11	10 12317		6,75	74	34	10 12467		13,00	102	51	1 12539	
2,00	38	12	10 12320		6,80	74	34	10 20672		13,50	107	54	1 12545	
2,10	40	13	10 12323		New! 6,90	74	34	10 48353		14,00	107	54	1 12551	
2,20	40	13	10 12326		7,00	74	34	10 12470		14,50	111	56	1 12554	
2,25	40	13	10 12329		New! 7,10	74	34	10 48362		15,00	111	56	1 12557	
2,30	40	13	10 12332		7,20	74	34	10 20681		New! 15,25	115	58	1 48797	
2,40	43	14	10 12335		7,25	74	34	10 27317		15,50	115	58	1 12560	
2,50	43	14	10 12338		New! 7,30	74	34	10 48365		New! 15,75	115	58	1 20834	
2,60	43	14	10 12341		7,40	74	34	10 30591		16,00	115	58	1 12563	
2,70	46	16	10 12344		7,50	74	34	10 12473		16,50	119	60	1 12566	
2,75	46	16	10 12347		New! 7,60	79	37	10 48368		17,00	119	60	1 12569	
2,80	46	16	10 12350		New! 7,70	79	37	10 48383		17,50	123	62	1 12572	
2,90	46	16	10 12353		7,75	79	37	10 12476		18,00	123	62	1 12575	
3,00	46	16	10 12356		7,80	79	37	10 20696		18,50	127	64	1 12578	
3,10	49	18	10 12359		New! 7,90	79	37	10 48386		19,00	127	64	1 12581	
3,20	49	18	10 12362		8,00	79	37	10 12479		19,50	131	66	1 12584	
3,25	49	18	10 12365		New! 8,10	79	37	10 48389		20,00	131	66	1 12587	
3,30	49	18	10 12368		New! 8,20	79	37	10 48392						
3,40	52	20	10 12371		8,25	79	37	10 12482						
3,50	52	20	10 12374		New! 8,30	79	37	10 48395						
3,60	52	20	10 12377		New! 8,40	79	37	10 48398						
3,70	52	20	10 12380		8,50	79	37	10 12485						
3,75	52	20	10 12383		New! 8,70	84	40	10 20720						
3,80	55	22	10 12386		8,75	84	40	10 12488						
3,90	55	22	10 12389		New! 8,80	84	40	10 48401						
4,00	55	22	10 12392		New! 8,90	84	40	10 48404						
4,10	55	22	10 12395		9,00	84	40	10 12491						
4,20	55	22	10 12398		9,10	84	40	10 30592						
4,25	55	22	10 12401		New! 9,20	84	40	10 48407						
4,30	58	24	10 12404		9,25	84	40	10 12494						
4,40	58	24	10 12407		New! 9,30	84	40	10 48410						
4,50	58	24	10 12410		New! 9,40	84	40	10 48413						
4,60	58	24	10 20636		9,50	84	40	10 12497						
4,70	58	24	10 20639		New! 9,60	89	43	10 48416						
4,75	58	24	10 12413		New! 9,70	89	43	10 48419						
4,80	62	26	10 12416		9,75	89	43	10 27334						
4,90	62	26	10 12419		New! 9,80	89	43	10 48422						
5,00	62	26	10 12422		New! 9,90	89	43	10 48335						
5,10	62	26	10 12425		10,00	89	43	10 12500						
5,20	62	26	10 12428		New! 10,10	89	43	1 48428						
5,25	62	26	10 12431		New! 10,15	89	43	1 16195						
5,30	62	26	10 12434		10,20	89	43	1 20756						
5,40	66	28	10 12437		10,25	89	43	1 12503						
5,50	66	28	10 12440		New! 10,30	89	43	1 48431						
5,60	66	28	10 12443		10,50	89	43	1 12506						
5,70	66	28	10 12446		New! 10,80	95	47	1 48434						
5,75	66	28	10 12449		11,00	95	47	1 12512						

Set **1476**



19 Pcs

Cont. Ø	N° Art.	€
1 - 10 x 0,5 mm	11935	



Ref. **1030**

BROCA MANGO CILÍNDRICO HSS LARGA

HSS Straight Shank Long Drill Bit

Foret queue cylindrique HSS longue



HSS	DIN 340 N	118°		Serie Larga Long Series Série longue
------------	--------------	------	--	---

Aceros <850 N/mm ² Steel / Aciers	Fundición Cast Iron Fonte	Aluminio Aluminium
---	--	------------------------------

D mm	L mm	I mm		Nº Art.	€	D mm	L mm	I mm		Nº Art.	€
0,50	32	12	10	26656		4,20	119	78	10	11687	
0,60	35	15	10	26658		4,25	119	78	10	11690	
0,70	42	21	10	19467		4,30	126	82	10	11693	
0,80	46	25	10	24592		4,40	126	82	10	11696	
0,90	51	29	10	26659		4,50	126	82	10	11699	
1,00	56	33	10	11573		4,60	126	82	10	11702	
1,10	60	37	10	11576		4,70	126	82	10	19955	
1,20	65	41	10	11579		4,75	126	82	10	11705	
1,25	65	41	10	11582		4,80	132	87	10	11708	
1,30	65	41	10	11585		4,90	132	87	10	11711	
1,40	70	45	10	11588		5,00	132	87	10	11714	
New! 1,45	70	45	10	31704		5,10	132	87	10	11717	
1,50	70	45	10	11591		5,20	132	87	10	11720	
1,60	76	50	10	11594		5,25	132	87	10	11723	
1,70	76	50	10	11597		5,30	132	87	10	11726	
1,75	80	53	10	11600		5,40	139	91	10	11729	
1,80	80	53	10	11603		5,50	139	91	10	11732	
1,90	80	53	10	11606		5,60	139	91	10	11735	
2,00	85	56	10	11609		5,70	139	91	10	11738	
2,10	85	56	10	11612		5,75	139	91	10	11741	
2,20	90	59	10	11615		5,80	139	91	10	11744	
2,25	90	59	10	11618		5,90	139	91	10	11747	
2,30	90	59	10	11621		6,00	139	91	10	11750	
2,40	95	62	10	11624		6,10	148	97	10	11753	
2,50	95	62	10	11627		6,20	148	97	10	11756	
2,60	95	62	10	11630		6,25	148	97	10	11759	
2,70	100	66	10	11633		6,30	148	97	10	11762	
2,75	100	66	10	11636		6,40	148	97	10	11765	
2,80	100	66	10	11639		6,50	148	97	10	11768	
2,90	100	66	10	11642		6,60	148	97	10	11771	
3,00	100	66	10	11645		6,70	148	97	10	11774	
3,10	106	69	10	11648		6,75	156	102	10	11777	
3,20	106	69	10	11651		6,80	156	102	10	11780	
3,25	106	69	10	11654		6,90	156	102	10	11783	
3,30	106	69	10	11657		7,00	156	102	10	11786	
3,40	112	73	10	11660		7,10	156	102	10	11789	
3,50	112	73	10	11663		7,20	156	102	10	11792	
3,60	112	73	10	11666		7,25	156	102	10	11795	
3,70	112	73	10	11669		7,30	156	102	10	11798	
3,75	112	73	10	11672		7,40	156	102	10	11801	
3,80	119	78	10	11675		7,50	156	102	10	11804	
3,90	119	78	10	11678		7,60	165	109	10	11807	
4,00	119	78	10	11681		7,70	165	109	10	11810	
4,10	119	78	10	11684		7,75	165	109	10	11813	





Ref. **1030**

BROCA MANGO CILÍNDRICO HSS LARGA

HSS Straight Shank Long Drill Bit
Foret queue cylindrique HSS longue



D mm	L mm	I mm		Nº Art.	€	D mm	L mm	I mm		Nº Art.	€
7,80	165	109	10	11816		11,80	195	128	1	11960	
7,90	165	109	10	11819		11,90	205	134	1	11963	
8,00	165	109	10	11822		12,00	205	134	1	11966	
8,10	165	109	5	11825		12,20	205	134	1	11972	
8,20	165	109	5	11828		12,25	205	134	1	11975	
8,25	165	109	5	11831		12,30	205	134	1	11978	
8,30	165	109	5	11834		12,50	205	134	1	11984	
8,40	165	109	5	11837		12,75	205	134	1	11993	
8,50	165	109	5	11840		13,00	205	134	1	12002	
8,60	175	115	5	11843		13,25	214	140	1	12005	
8,70	175	115	5	11846		13,50	214	140	1	12008	
8,75	175	115	5	11849		13,75	214	140	1	12011	
8,80	175	115	5	11852		14,00	214	140	1	12014	
8,90	175	115	5	11855		14,25	220	144	1	12017	
9,00	175	115	5	11858		14,50	220	144	1	12020	
9,10	175	115	5	11861		14,75	220	144	1	12023	
9,20	175	115	5	11864		15,00	220	144	1	12026	
9,25	175	115	5	11867		15,25	227	149	1	12029	
9,30	175	115	5	11870		15,50	227	149	1	12032	
9,40	175	115	5	11873		15,75	227	149	1	12035	
9,50	175	115	5	11876		16,00	227	149	1	12038	
9,60	184	121	5	11879		16,25	235	154	1	12041	
9,70	184	121	5	11882		16,50	235	154	1	12044	
9,75	184	121	5	11885		16,75	235	154	1	12047	
9,80	184	121	5	11888		17,00	235	154	1	12050	
9,90	184	121	5	11891		17,25	241	158	1	12053	
10,00	184	121	5	11894		17,50	241	158	1	12056	
10,20	184	121	1	11900		17,75	241	158	1	12059	
10,25	184	121	1	11903		18,00	241	158	1	12062	
10,50	184	121	1	11912		18,25	247	162	1	12065	
10,75	195	128	1	11921		18,50	247	162	1	12068	
10,80	195	128	1	11924		New! 18,75	247	162	1	12071	
11,00	195	128	1	11930		19,00	247	162	1	12074	
11,10	195	128	1	30588		New! 19,25	254	166	1	12077	
11,25	195	128	1	11939		19,50	254	166	1	12080	
11,50	195	128	1	11948		19,75	254	166	1	12083	
11,75	195	128	1	11957		20,00	254	166	1	12086	



Ref. **1003**

BROCA MANGO CILÍNDRICO HSS LARGA

HSS Straight Shank Long Drill Bit
Foret queue cylindrique HSS longue



HSS	DIN 340 N	118°		Serie Larga Long Series Série longue
------------	--------------	------	--	---

Aceros <850 N/mm ² Steel / Aciers	Fundición Cast Iron Fonte	Aluminio Aluminium
---	--	------------------------------

D mm	L mm	I mm		Nº Art.	€
2,00	85	56	1	10572	
2,50	95	62	1	10573	
3,00	100	66	1	10581	
3,25	106	69	1	10582	
3,50	112	73	1	10584	
4,00	119	78	1	10585	
4,25	119	78	1	10591	
4,50	126	82	1	10593	
5,00	132	87	1	10596	
5,50	139	91	1	10599	
6,00	139	91	1	10602	
6,50	148	97	1	10605	
7,00	156	102	1	10608	
7,50	156	102	1	10611	
8,00	165	109	1	10614	
8,50	165	109	1	10617	
9,00	175	115	1	10620	
10,00	184	121	1	10623	
11,00	195	128	1	10629	
12,00	205	134	1	10632	
13,00	205	134	1	10635	



Línea 1 m - Ref. 1003



∅	2	2,5	3	3,25	3,5	4	4,25	4,5	5	5,5	6	6,5	7	7,5	8	8,5	9	10	12
Pcs	5	5	5	5	5	5	5	5	5	5	5	5	5	3	5	3	3	5	2

Ref. 4995 - N° Art. 71682: €

Display 15 - Ref. 1003



∅	7,5	8	8,5	9	10	11	12	13		
Pcs	5	5	3	3	3	2	2	2		
∅	4,25	4,25	4,5	5	5	5,5	6	6	6,5	7
Pcs	3	2	5	3	2	3	3	2	5	5
∅	2	2,5	3	3	3,25	3,25	3,5	3,5	4	4
Pcs	5	5	3	2	3	2	3	2	3	2

Ref. 4995 - N° Art. 22328: €

Ref. **1040**

BROCA MANGO CILÍNDRICO HSS EXTRA LARGA

HSS Straight Shank Extra Long Drill Bit
Foret queue cylindrique HSS extra-longue



HSS	DIN 1869 N	118°		Serie Extra Larga Extra Long Series Série extra-longue
------------	---------------	------	--	---

Aceros <850 N/mm ² Steel / Aciers	Fundición Cast Iron Fonte	Aluminio Aluminium
---	--	------------------------------

D mm	L mm	I mm		Nº Art.	€
2,00	125	85	1	12158	
2,50	140	95	1	12161	
3,00	150	100	1	12164	
3,00	190	136	1	12167	
3,50	165	115	1	12170	
3,50	210	145	1	12173	
3,50	265	180	1	12176	
4,00	175	120	1	12179	
4,00	220	150	1	12182	
4,00	280	190	1	12185	
4,50	185	125	1	12188	
4,50	235	160	1	12191	
4,50	295	200	1	12194	
5,00	195	135	1	12197	
5,00	245	170	1	12200	
5,00	315	210	1	12203	
5,50	205	140	1	12206	
5,50	260	180	1	12209	
5,50	330	225	1	12212	
6,00	205	140	1	12215	
6,00	260	180	1	12218	
6,00	330	225	1	12221	
6,50	215	150	1	12224	
6,50	275	190	1	12227	

D mm	L mm	I mm		Nº Art.	€
6,50	350	235	1	12230	
7,00	225	155	1	12233	
7,00	290	200	1	12236	
7,00	370	250	1	12239	
7,50	225	155	1	12242	
7,50	290	200	1	12245	
7,50	370	250	1	12248	
8,00	240	165	1	12251	
8,00	305	210	1	12254	
8,00	390	265	1	12257	
8,50	240	165	1	12260	
8,50	305	210	1	12263	
8,50	390	265	1	12266	
9,00	250	175	1	12269	
9,00	320	220	1	12272	
9,00	410	280	1	12275	
9,50	250	175	1	12278	
9,50	320	220	1	12281	
9,50	410	280	1	12284	
10,00	265	185	1	12287	
10,00	340	235	1	12290	
10,00	430	295	1	12293	
11,00	280	195	1	28866	
12,00	295	205	1	28867	



Ref. **1090**

BROCA MANGO CILÍNDRICO HSS LAMINADA

HSS Straight Shank Rolled Drill Bit
Foret queue cylindrique HSS laminé



HSS

Laminada
Rolled
Laminé

D mm	L mm	I mm		Nº Art.	€	D mm	L mm	I mm		Nº Art.	€	D mm	L mm	I mm		Nº Art.	€
1,00	34	12	10	21440		4,25	75	43	10	21485		8,00	117	75	10	21542	
1,50	40	18	10	21446		4,50	80	47	10	21488		8,50	117	75	10	21548	
2,00	49	24	10	21452		5,00	86	52	10	21494		9,00	125	81	10	21554	
2,50	57	30	10	21458		5,50	93	57	10	21503		10,00	133	87	10	21566	
3,00	61	33	10	21464		6,00	93	57	10	21509		11,00	142	94	5	21581	
3,25	65	36	10	21470		6,50	101	63	10	21518		12,00	151	101	5	21593	
3,50	70	39	10	21473		7,00	109	69	10	21527		13,00	151	101	5	21608	
4,00	75	43	10	21482		7,50	109	69	10	21533							

Ref. **1009**

BROCA MANGO CILÍNDRICO HSS LAMINADA

HSS Straight Shank Rolled Drill Bit
Foret queue cylindrique HSS laminé



HSS

Laminada
Rolled
Laminé

D mm	L mm	I mm		Nº Art.	€	D mm	L mm	I mm		Nº Art.	€	D mm	L mm	I mm		Nº Art.	€
1,00	34	12	2	30173	*	4,25	75	43	1	30186		8,00	117	75	1	30201	
1,50	40	18	2	30175	*	4,50	80	47	1	30187		8,50	117	75	1	30203	
2,00	49	24	2	30177	*	5,00	86	52	1	30189		9,00	125	81	1	30205	
2,50	57	30	2	30179	*	5,50	93	57	1	30191		10,00	133	87	1	30209	
3,00	61	33	2	30181	*	6,00	93	57	1	30193		11,00	142	94	1	30213	
3,25	65	36	2	30182	*	6,50	101	63	1	30195		12,00	151	101	1	30217	
3,50	70	39	2	30183	*	7,00	109	69	1	30197		13,00	151	101	1	30221	
4,00	75	43	2	30185	*	7,50	109	69	1	30199							

* € = 2 uds.



Set **1490**
6 Pcs

Cont. Ø	Nº Art.	€
2 - 3 - 4 - 5 - 6 - 8 mm	30204	



Set **1491**
19 Pcs

Cont. Ø	Nº Art.	€
1 - 10 x 0,5 mm	30206	



Set **1492**
25 Pcs

Cont. Ø	Nº Art.	€
1 - 13 x 0,5 mm	30210	



Set **1499**
170 Pcs

Cont. Ø	Nº Art.	€
1-10 × 0,5 mm Ø 1-8: 10 pcs/Ø Ø 8,5-10: 5 pcs/Ø	69084	



Ref. **1637**

TOPE PROFUNDIDAD DE BROCA

Drill Bit Depth Stop
Butées de perçage



C45

D mm		Nº Art.	€
3,00	1	13762	
4,00	1	13763	
5,00	1	13764	
6,00	1	13765	
8,00	1	13766	
10,00	1	13767	



6 Sets

Nº Art.	€
13768	



Set 6 Pcs

Cont. Ø	Nº Art.	€
3-4-5-6-8-10 mm	81689	

Ref. **1461**

SET TOPES DE PROFUNDIDAD DE BROCAS

Drill Bit Depth Stop Set
Jeu butées de perçage



13
pcs

Brocas Metal
Metal Drill Bits
Forets métal
3-4-5-6-8-10 mm

Topes de profundidad
Depth Stops
Butées de perçage



Nº Art.	€
79876	

Llave Allen / Allen Wrench / Clé Allen 1 pc



Ref. **1110**

BROCA MANGO CÓNICO HSS

HSS Morse Taper Shank Drill Bit
Foret queue cône morse HSS

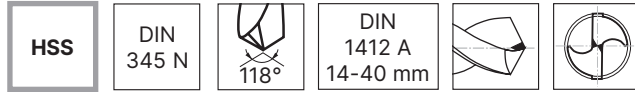

Aceros <850 N/mm ² Steel / Aciers	Aceros <1000 N/mm ² Steel / Aciers	Fundición Cast Iron Fonte	Cobre Copper Cuivre
---	--	--	----------------------------------



D	L	I	CM	N°	€	D	L	I	CM	N°	€	D	L	I	CM	N°	€
mm	mm	mm		Art.		mm	mm	mm		Art.		mm	mm	mm		Art.	
5,00	133	52	1	14426		16,50	223	125	2	14564		28,00	291	170	3	14702	
5,25	133	52	1	14429		16,75	223	125	2	14567		28,25	296	175	3	14705	
5,50	138	57	1	14432		17,00	223	125	2	14570		28,50	296	175	3	14708	
5,75	138	57	1	14435		17,25	228	130	2	14573		28,75	296	175	3	14711	
6,00	138	57	1	14438		17,50	228	130	2	14576		29,00	296	175	3	14714	
6,25	144	63	1	14441		17,75	228	130	2	14579		29,25	296	175	3	14717	
6,50	144	63	1	14444		18,00	228	130	2	14582		29,50	296	175	3	14720	
6,75	150	69	1	14447		18,25	233	135	2	14585		29,75	296	175	3	14723	
7,00	150	69	1	14450		18,50	233	135	2	14588		30,00	296	175	3	14726	
7,25	150	69	1	14453		18,75	233	135	2	14591		30,25	301	180	3	14729	
7,50	150	69	1	14456		19,00	233	135	2	14594		30,50	301	180	3	14732	
7,75	156	75	1	14459		19,25	238	140	2	14597		30,75	301	180	3	14735	
8,00	156	75	1	14462		19,50	238	140	2	14600		31,00	301	180	3	14738	
8,25	156	75	1	14465		19,75	238	140	2	14603		31,25	301	180	3	14741	
8,50	156	75	1	14468		20,00	238	140	2	14606		31,50	301	180	3	14744	
8,75	162	81	1	14471		20,25	243	145	2	14609		31,75	306	185	3	14747	
9,00	162	81	1	14474		20,50	243	145	2	14612		32,00	334	185	4	14750	
9,25	162	81	1	14477		20,75	243	145	2	14615		32,50	334	185	4	14753	
9,50	162	81	1	14480		21,00	243	145	2	14618		33,00	334	185	4	14756	
9,75	168	87	1	14483		21,25	248	150	2	14621		33,50	334	185	4	14759	
10,00	168	87	1	14486		21,50	248	150	2	14624		34,00	339	190	4	14762	
10,25	168	87	1	14489		21,75	248	150	2	14627		34,50	339	190	4	14765	
10,50	168	87	1	14492		22,00	248	150	2	14630		35,00	339	190	4	14768	
10,75	175	94	1	14495		22,25	248	150	2	14633		35,50	339	190	4	14771	
11,00	175	94	1	14498		22,50	253	155	2	14636		36,00	344	195	4	14774	
11,25	175	94	1	14501		22,75	253	155	2	14639		36,50	344	195	4	14777	
11,50	175	94	1	14504		23,00	253	155	2	14642		37,00	344	195	4	14780	
11,75	175	94	1	14507		23,25	276	155	3	14645		37,50	344	195	4	14783	
12,00	182	101	1	14510		23,50	276	155	3	14648		38,00	349	200	4	14786	
12,25	182	101	1	14513		23,75	281	160	3	14651		38,50	349	200	4	14789	
12,50	182	101	1	14516		24,00	281	160	3	14654		39,00	349	200	4	14792	
12,75	182	101	1	14519		24,25	281	160	3	14657		39,50	349	200	4	14795	
13,00	182	101	1	14522		24,50	281	160	3	14660		40,00	349	200	4	14798	
13,25	189	108	1	14525		24,75	281	160	3	14663		40,50	354	205	4	14801	
13,50	189	108	1	14528		25,00	281	160	3	14666		41,00	354	205	4	14804	
13,75	189	108	1	14531		25,25	286	165	3	14669		41,50	354	205	4	14807	
14,00	189	108	1	14534		25,50	286	165	3	14672		42,00	354	205	4	14810	
14,25	212	114	2	14537		25,75	286	165	3	14675		42,50	354	205	4	14813	
14,50	212	114	2	14540		26,00	286	165	3	14678		43,00	359	210	4	14816	
14,75	212	114	2	14543		26,25	286	165	3	14681		43,50	359	210	4	14819	
15,00	212	114	2	14546		26,50	286	165	3	14684		44,00	359	210	4	14822	
15,25	218	120	2	14549		26,75	291	170	3	14687		44,50	359	210	4	14825	
15,50	218	120	2	14552		27,00	291	170	3	14690		45,00	359	210	4	14828	
15,75	218	120	2	14555		27,25	291	170	3	14693		45,50	364	215	4	14831	
16,00	218	120	2	14558		27,50	291	170	3	14696		46,00	364	215	4	14834	
16,25	223	125	2	14561		27,75	291	170	3	14699		46,50	364	215	4	14837	





Ref. **1110**

BROCA MANGO CÓNICO HSS

HSS Morse Taper Shank Drill Bit
Foret queue cône morse HSS

D mm	L mm	I mm	CM	Nº Art.	€	D mm	L mm	I mm	CM	Nº Art.	€	D mm	L mm	I mm	CM	Nº Art.	€
47,00	364	215	4	14840		64,00	432	245	5	14903		81,00	519	265	6	14954	
47,50	364	215	4	14843		65,00	432	245	5	14906		82,00	519	265	6	14957	
48,00	369	220	4	14846		66,00	432	245	5	14909		83,00	519	265	6	14960	
48,50	369	220	4	14849		67,00	432	245	5	14912		84,00	519	265	6	14963	
49,00	369	220	4	14852		68,00	437	250	5	14915		85,00	519	265	6	14966	
49,50	369	220	4	14855		69,00	437	250	5	14918		86,00	524	270	6	14969	
50,00	369	220	4	14858		70,00	437	250	5	14921		87,00	524	270	6	14972	
51,00	412	225	5	14864		>70 mm bajo demanda						88,00	524	270	6	14975	
52,00	412	225	5	14867		upon request / sur demande						89,00	524	270	6	14978	
53,00	412	225	5	14870		71,00	437	250	5	14924		90,00	524	270	6	14981	
54,00	417	230	5	14873		72,00	442	255	5	14927		91,00	529	275	6	14984	
55,00	417	230	5	14876		73,00	442	255	5	14930		92,00	529	275	6	14987	
56,00	417	230	5	14879		74,00	442	255	5	14933		93,00	529	275	6	14990	
57,00	422	235	5	14882		75,00	442	255	5	14936		94,00	529	275	6	14993	
58,00	422	235	5	14885		76,00	447	260	5	14939		95,00	529	275	6	14996	
59,00	422	235	5	14888		77,00	514	260	6	14942		96,00	534	280	6	14999	
60,00	422	235	5	14891		78,00	514	260	6	14945		97,00	534	280	6	15002	
61,00	427	240	5	14894		79,00	514	260	6	14948		98,00	534	280	6	15005	
62,00	427	240	5	14897		80,00	514	260	6	14951		99,00	534	280	6	15008	
63,00	427	240	5	14900								100,00	534	280	6	15011	



Set 25 Pcs

Cont. Ø	Nº Art.	€
14-14,5-15-15,5-16-16,5-17-17,5-18-18,5-19-19,5-20-20,5-21-21,5-22-22,5-23-24-25-26-27-28-30 mm	14263	



Set 10 Pcs

Cont. Ø	Nº Art.	€
14-15-16-17-18-19-20-21-22-25 mm	19346	





Fabricando soluciones desde 1910

izartool.com

PORTABROCAS Y ACCESORIOS

Drill Chucks & Accessories

Mandrins et accessoires

Ref. **1802**

PORTABROCAS TALADROS PORTÁTILES CON LLAVE

Portable Drilling Machine Metal Drill-Chucks with Key

Mandrins métal perceuses portables avec clé



Mod. Monoblock

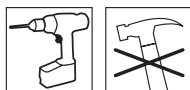

- | | | |
|------------------------------|-------------------------|-------------------------|
| - 1 única pieza | - Only one piece | - 1 Seule pièce |
| - Elimina roturas de dientes | - No teeth breaking | - Pas de casse de dents |
| - Ideal taladro portátil | - Ideal portable drills | - Perceuses à main |
| - Cierre con llave | - Key-lock | - Fermeture à clé |
| - Cuerpo metal | - Metal body | - Corps Métal |
| - Agujero interior | - Internal hole | - Trou intérieur |

Monoblock

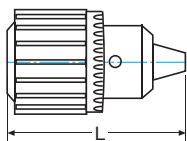

Mod.	Cap. mm	Fijación Fix.	L mm	Peso Weight Poids gr.	Nº Art.	€
00102	1-10	1/2X20 UNF	60	299	47491	
00131	1,5-13	3/8X24 UNF	77	501	47493	



2 Pcs.

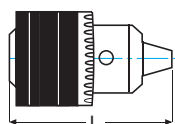

Mod.	Cap. mm	Fijación Fix.	L mm	Peso Weight Poids gr.	Nº Art.	€
00101	1-10	3/8X24 UNF	60	311	47490	
00132	1,5-13	1/2X20 UNF	77	492	47494	

Ref. **1807**

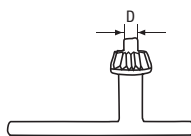

D mm	Mod.	Nº Art.	€
6	00102	16362	
	00101		
	00132		
6,3	00131	69316	





Ref. **1806**

PORTABROCAS TALADROS PORTÁTILES - AUTOMÁTICO METAL

Portable Drilling Machine Drill-Chucks - Metal Automatic
Mandrins perceuses portables – automatique métal

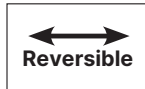

- | | | |
|---------------------------------|-----------------------------|--------------------------------|
| - Cierre seguridad | - Security lock | - Fermeture sureté |
| - Capacidad 13: Garras MD | - Capacity 13: carbide jaws | - Capacité 13: pinces carbure |
| - Ideal atornilladores | - Ideal screwdrivers | - Idéal Tournevis |
| - Taladros percusión de batería | - Battery percussion drills | - Perceuses percusion batterie |
| - Reversible | - Reversible | - Reversible |
| - Cuerpo metal ligero | - Light metal body | - Corps métal léger |
| - Agujero interior | - Internal hole | - Trou intérieur |
| - No apto martillos SDS | - Not suitable SDS | - Non apte pour SDS |

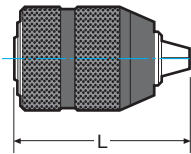

Mod.	Cap. mm	Fijación Fix.	L mm	Peso Weight Poids gr.	Nº Art.	€
00101	1-10	3/8X24 UNF	64,5	311	14706	
00102	1-10	1/2x20 UNF	64,5	313	14712	
00131	2-13	3/8X24 UNF	74,5	397	14718	
00132	2-13	1/2X20 UNF	74,5	328	14736	



Ref. **1804**

PORTABROCAS TALADROS PORTATILES Y ESTACIONARIOS

Portable & Stationary Drilling Machine Drill-Chucks
Mandrins perceuses portables et fixes



- | | | |
|--|---|--|
| - Cierre seguridad | - Security lock | - Fermeture sureté |
| - Taladros industriales y percusión (aptos martillos alta frecuencia SDS plus) | - Industrial & percussion drills (suitable high frequency hammers SDS plus) | - Perceuses industrielles et précisions (aptos pour marteaux haute fréquence SDS plus) |
| - Autoapriete automático | - Automatic self-tightening | - Auto-attachement |

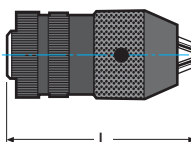

Mod.	Cap. mm	Fijación Fix.	L mm	Peso Weight Poids gr.	Nº Art.	€
00101	0-10	3/8X24 UNF	74	350	16358	
00102	0-10	1/2x20 UNF	77	593	16359	
00132	1-13	1/2X20 UNF	96	670	16361	



Ref. **1803**

PORTABROCAS PRECISIÓN TALADROS PORTATILES Y ESTACIONARIOS

Portable & Stationary Drilling Machine Precision Drill-Chucks

Mandrins précision perceuses portables et fixes



→
Derecha
Right - Droite



- Uso Taladros industriales y profesionales
- Fijaciones: Rosca taladro portátil y Cónica taladro fijo
- Autoapriete automático
- Giro a derechas

- Use for Industrial & professional drills
- Fixing: Threaded portable drills & Tapered for fixed drills
- Automatic self-tightening
- Right turning

- Usage perceuses industrielles et professionnelles
- Fixations: Filet perceuse portable et conique perceuse à colonne
- Amenchement automatique
- Tour à droite

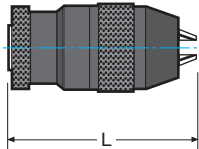

Mod.	Cap. mm	Fijación Fix.	L mm	Peso Weight Poids gr.	Nº Art.	€	Garras Jaws Pincas Art.
00101	0,8-10	B12 *	86	619	16349		56894
00102	0,8-10	3/8X24 UNF	78	451	16350		56894
00103	0,8-10	1/2X20UNF	78	452	16351		56894
00131	1-13	B16 *	103	800	16352		24565
00132	2-13	3/8X24 UNF	83	764	16353		56894
00133	2-13	1/2X20 UNF	83	583	16354		56894
00161	3-16	B16	105	1.180	16355		24565
00162	3-16	B18 *	105	1.152	16356		24565
00163	3-16	1/2X20 UNF	105	1.185	16357		24565
00164	5-20	B18 *	131	2.165	19957		24566



* RECOMENDACIONES:

1. Limpiar muy bien la espiga y el agujero del portabrocas antes de introducir la espiga.
2. Cogiendo el porta-brocas en una mano, insertar la espiga con la otra mano.
3. Dar un pequeño golpe seco con una maza de Nylon.

* RECOMMENDATIONS:

1. Thoroughly clean the spindle and the chuck-hole before inserting the spindle.
2. Holding the chuck in one hand, insert the spike with the other hand.
3. Give a small heavy thud with a Nylon mace.

* RECOMMANDATIONS :

1. Nettoyez soigneusement l'arbre d'attachement et le trou du mandrin avant d'insérer l'arbre.
2. En tenant le mandrin d'une main, insérez l'arbre avec l'autre main.
3. Donnez un petit coup sec avec un mace en nylon.

Ref. **1800**

PORTABROCAS MANUAL

Hand Drill-Chucks

Mandrin à main

New!



CAP.	Nº Art.	€
0,3 - 3,5	45431	



- Portabrocas fabricado en aleación de aluminio

- Aluminium alloyed body

- Mandrin fabriqué en alliage d'aluminium



Ref. 1809

ACCESORIOS

Accessories
Accessoires

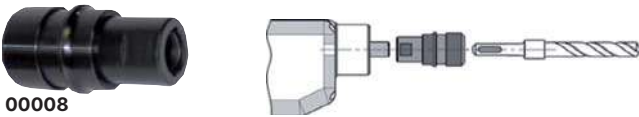
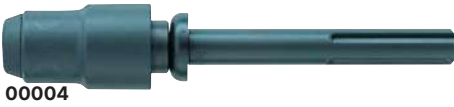



Conversores / Converters / Convertisseurs

Mod.	Entrada Inlet Entrée	Fijación Fix	Nº Art.	€
00001	3/8X24h	3/8X24h	16363	
00002	3/8X24h	1/2X20h	16364	
00003	SDS plus	1/2X20h	16365	
00004	SDS max	SDS plus	17258	
00005	Hex. 13 mm	SDS plus	17259	
00008	1/2x20h	SDS plus	20485	
New! 00021	Hexagonal	M14	24273	

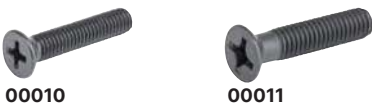

Tornillos / Screws / Vis



Mod.	Entrada Inlet Entrée	Fijación Fix		Nº Art.	€
00010	M5x18 mm	3/8x24	1	25321	
00011	M6x25 mm	1/2x20	1	25323	

Ref. 1819

GARRAS

Jaws
Pinces

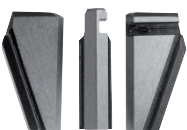

Mod.	Garras Jaws Pinces	Nº Art.	€
1013ROS	10/13 mm ROSCA (Ref. 1803)	56894	
13DIN16	13DIN / 16 mm (Ref. 1803)	24565	
16	16 mm	24566	



Línea 1 m 18PB - Refs. 1802 - 1803 - 1804 - 1806 - 1807 - 1809

PORTABROCAS TALADROS PORTATILES Y ESTACIONARIOS

Portable & Stationary Drilling Machine Drill-Chucks

Mandrins perceuses portables et fixes



	Ref. 1802 Cap. 1-10 Fix 1/2 x 20h	Ref. 1802 Cap. 1,5-13 Fix 1/2 x 20h	Ref. 1803 Cap. 0,8-10 Fix 1/2 x 20h	Ref. 1803 Cap. 2-13 Fix 1/2 x 20h	Ref. 1804 Cap. 1-13 Fix 1/2 x 20h	Ref. 1804 Cap. 1-13 Fix 1/2 x 20h	Ref. 1806 Cap. 1-10 Fix 1/2 x 20h	Ref. 1806 Cap. 2-13 Fix 1/2 x 20h	Ref. 1807 Llave Key - Clé D 6 mm	Ref. 1809 SDS plus Fix 1/2 x 20h
∅										
Pcs	2	2	2	2	1	1	2	2	3	5

Ref. 4995 - N° Art. 72080: €

Línea 33 cm 18PB - Refs. 1802 - 1803 - 1806

PORTABROCAS TALADROS PORTATILES Y ESTACIONARIOS

Portable & Stationary Drilling Machine Drill-Chucks

Mandrins perceuses portables et fixes



	Ref. 1802 Cap. 1,5-13 Fix 1/2 x 20h	Ref. 1803 Cap. 0,8-10 Fix 1/2 x 20h	Ref. 1803 Cap. 2-13 Fix 1/2 x 20h	Ref. 1806 Cap. 1-10 Fix. 1/2 x 20h	Ref. 1806 Cap. 2-13 Fix 1/2 x 20h
∅					
Pcs	2	2	2	2	2

Ref. 4995 - N° Art. 72081: €

Display 12 - Refs. 1802 - 1803 - 1804 - 1806 - 1807 - 1809

PORTABROCAS TALADROS PORTATILES Y ESTACIONARIOS

Portable & Stationary Drilling Machine Drill-Chucks

Mandrins perceuses portables et fixes



	Ref. 1802 Cap. 1-10 Fix. 1/2 x 20h	Ref. 1802 Cap. 1,5-13 Fix. 1/2 x 20h	Ref. 1806 Cap. 1-10 Fix. 1/2 x 20h	Ref. 1806 Cap. 1-10 Fix. 1/2 x 20h	Ref. 1806 Cap. 2-13 Fix. 1/2 x 20h	Ref. 1806 Cap. 2-13 Fix. 1/2 x 20h
∅						
Pcs	2	2	1	1	1	1
	Ref. 1803 Cap. 0,8-10 Fix. 1/2 x 20h	Ref. 1803 Cap. 2-13 Fix. 1/2 x 20h	Ref. 1804 Cap. 1-13 Fix. 1/2 x 20h	Ref. 1804 Cap. 1-13 Fix. 1/2 x 20h	Ref. 1809 SDS plus Mod. 00003	Ref. 1807 Llave Key - Clé D 6 mm
∅						
Pcs	2	2	1	1	5	5

Ref. 4995 - N° Art. 22334: €



Ref. **1101**

CONO REDUCTOR

Reduction Sleeve
Douille de réduction



HSS

DIN
2185

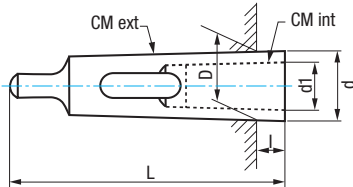

CM EXT.	CM INT.	L mm	I mm	D mm	d1 mm	d mm	N° Art.	€
2	1	92	17,00	17,780	12,065	18,60	16415	
3	1	99	5,00	23,825	12,065	24,10	16416	
3	2	112	18,00	23,825	17,780	24,70	16417	
4	1	124	6,50	31,267	12,065	31,60	16418	
4	2	124	6,50	31,267	17,780	31,60	16419	
4	3	140	22,50	31,267	23,825	32,40	16420	
5	3	156	6,50	44,399	23,825	44,70	16421	
5	4	171	21,50	44,399	31,267	45,50	16422	



Ref. **1102**

ALARGADOR CONOS

Extension Socket
Douille d'augmentation



HSS

DIN
2187

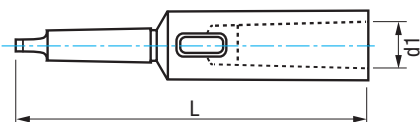

CM EXT.	CM INT.	L mm	d1 mm	N° Art.	€
1	2	160	17,78	16423	
2	1	159	12,07	16427	
2	2	176	17,78	16433	
2	3	195	23,83	16424	
3	1	176	12,07	16428	
3	2	194	17,78	16429	
3	3	215	23,83	16434	
3	4	239	31,27	16425	
4	1	200	12,07	16430	
4	2	215	17,78	16431	
4	3	240	23,83	16432	
4	4	265	31,27	16435	
4	5	299	44,39	16426	



Ref. **1103**

ESPIGA SUJECIÓN

Spike CM Taper
Arbre d'attachement



HSS

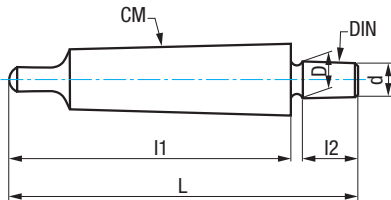

CM	DIN	L mm	I1 mm	D mm	d mm	I2 mm		Nº Art.	€
1	B12	89,00	62,00	12,065	11,10	18,50	1	16440	
2	B12	106,00	75,00	12,065	11,10	18,50	1	16441	
2	B16	111,00	75,00	15,733	14,50	24,00	1	16442	
2	B18	118,00	75,00	17,780	16,20	32,00	1	16443	
3	B12	126,00	94,00	12,065	11,10	18,50	1	16444	
3	B16	134,00	94,00	15,733	14,50	24,00	1	16445	
3	B18	140,00	94,00	17,780	16,20	32,00	1	21873	
4	B16	158,00	117,50	15,733	14,50	24,00	1	16446	
4	B18	166,50	117,50	17,780	16,20	32,00	1	16447	
5	B16	194	149,50	15,733	14,50	24,00	1	66764	
5	B18	202	149,50	17,780	16,20	32,00	1	66765	



Ref. **1104**

CUÑA EXPULSORA

Drill Drift
Chasse cône standard



HSS

CM Ext. min.	CM Ext. max.	L mm		Nº Art.	€
1	2	116	1	16436	
2	3	150	1	16437	
3	4	199	1	16438	
4	5	251	1	16439	



Ref. **9994**

MÁQUINA AFILADORA BROCAS

Drill Bit Sharpening Machine
Machine affûteuse forets



Mod. **XP**



Cap. mm	Punta Point Pointe	Uso Use Usage	Nº Art.	€
2,5-13	118°	HSS, TIN, HSSE, MD / HM / Carbure, Pared / Masonry / Béton + Split Point	38416	

Incluida Muela y medidor de ángulos
Wheel & Angle Meter included
Compris meule et compteur d'angle



Mod. **500**



Cap. mm	Punta Point Pointe	Uso Use Usage	Nº Art.	€
2,5-13	118°-135°	HSS, TIN, HSSE, MD / HM / Carbure, Pared / Masonry / Béton + Split Point	45121	

Incluida Muela K180 y medidor de ángulos
Wheel K180 & Angle Meter included
Compris meule K180 et compteur d'angle



Mod. **750**



Cap. mm	Punta Point Pointe	Uso Use Usage	Nº Art.	€
2,5-19	115°-140°	HSS, TIN, HSSE, MD / HM / Carbure, Pared / Masonry / Béton + Split Point	38418	

Incluida Muela K180 y medidor de ángulos
Wheel K180 & Angle Meter included
Compris meule K180 et compteur d'angle



* INSTRUCCIONES USO / Directions for use / Instructions d'emploi

PIEZAS RECAMBIO - Spare Parts - Pieces rechange

Porta Brocas - Drill Chucks - Mandrins

Mod.	Cap. mm	Punta Point Pointe	Nº Art.	€
XP	2,5-13	118°	39712	
500	2,5-13	118°-135°	47218	
500-750	2,5-19	115°-140°	40343	

Muela - Wheel - Meule

Mod.	Grano Grain	Máquina Machine	Cap. mm	Nº Art.	€
K180	Fino Fine Fin	XP-500-750	2,5-19	40344	
K100	Grueso Coarse Gros	750	13-19	43414	



BROCAS ESPECIALES

Special Drill Bits

Forets spéciaux

Ref. **1602**

BROCA ESCALONADA HSS

HSS Step Drill Bit
Foret étagé HSS



- Nueva punta robusta autocentrante
- Avellanado especial 45°
- Menor desgaste y esfuerzo de corte
- Mayor rendimiento y vida útil de la herramienta
- Mejor evacuación de viruta
- Acabado sin rebabas

- New autocentering robust point
- Special 45° Countersinking
- Lower wear and cutting effort
- Better performance & longer tool life
- Better chipping-off
- No-burr finishing

- Nouvelle pointe plus robuste autocentrante
- Ébavurage spécial à 45°
- Réduction de l'usure et de l'effort de coupe
- Augmentation de la performance et vie utile de l'outil
- Meilleure évacuation des copeaux
- Finition sans bavures



Chapa
Sheets
Tôle

Materiales ferrosos
Ferrous Materials
Matériaux ferreux

Aceros
<850 N/mm²
Steel / Aciers

Plásticos
Plastics
Plastiques

Cap. mm	Nº Pasos Steps / Étages	d mm	L mm	Nº Art.	€
4-12	9 (4-5-6-7-8-9-10-11-12)	6	79	12048	
4-20	9 (4-6-8-10-12-14-16-18-20)	9	67	12054	
4-30	14 (4-6-8-10-12-14-16-18-20-22-24-26-28-30)	10	100	66484	
6-30	13 (6-8-10-12-14-16-18-20-22-24-26-28-30)	10	100	12060	
7-37	8 (7-12,5-15,2-18,6-20,4-22,5-28,3-37)	12	90	67619	
9-36	10 (9-12-15-18-21-24-27-30-33-36)	12	82	12066	
12-20	9 (12-13-14-15-16-17-18-19-20)	9	75	56798	
20-30	11 (20-21-22-23-24-25-26-27-28-29-30)	12	88	56799	
30-40	11 (30-31-32-33-34-35-36-37-38-39-40)	13	98	60715	
40-50	11 (40-41-42-43-44-45-46-47-48-49-50)	13	112	60716	
50-60	11 (50-51-52-53-54-55-56-57-58-59-60)	13	120	60717	



Set 3 Pcs

Cont.	Nº Art.	€
4-12, 4-20, 6-30 mm	43518	



Ref. **1622**

New!



Pag. 333



BROCA ESCALONADA ESPIRAL MANGO E6.3

E6.3 Shank Spiral Step Drill Bit
Foret étagé spirale queue E6.3



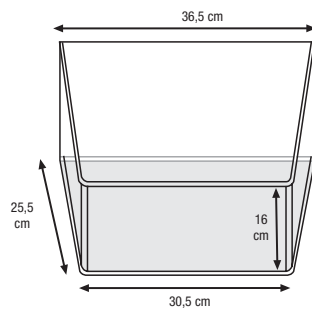

15 Pcs

N° Art.	€
65184	

Cap. mm	N° Art.	Uds.
4-12	12048	2
4-20	12054	2
6-30	12060	2
9-36	12066	2
12-20	56798	2
20-30	56799	2
30-40	60715	1
40-50	60716	1
50-60	60717	1

Línea 33 cm - Ref. 1602



∅	4-12	4-20	4-30	6-30	9-36	12-20
Pcs	1	1	1	1	1	1

Ref. 4995 - N° Art. 70954: €

Ref. **1612**

BROCA ESCALONADA **ESPIRAL** HSS

HSS **Spiral** Step Drill Bit
Foret étagé **spirale** HSS



- Canal optimizado para virutas largas y complejas
- Avellanado especial 45°
- Filos de corte protegidos y muy afilados
- Sin rebabas
- Mayor vida útil en materiales muy duros
- Autocentrado en chapas finas
- Optimized channel for long and complex chips
- Special 45° Countersinking
- Very sharpened & protected cutting edges
- No burrs
- Longer tool life in very hard materials
- Autocentering in fine sheets
- Goujure optimisée pour copeaux longs et complexes
- Ébavurage spécial à 45°
- Filets des arêtes de coupe protégés et plus affûtés
- Sans bavures
- Vie utile plus longue pour aciers plus durs
- Autocentrage sur toles minces

HSS						Chapa Sheets Tôle	Materiales ferrosos Ferrous Materials Matériaux ferreux
-----	--	--	--	--	--	-------------------------	---

Aceros <850 N/mm ² Steel / Aciers	Plásticos Plastics Plastiques
--	-------------------------------------

Cap. mm	Nº Pasos Steps / Étages	d mm	L mm	Nº Art.	€
4-12	9 (4-5-6-7-8-9-10-11-12)	6	80	67360	
4-20	9 (4-6-8-10-12-14-16-18-20)	9	69	67366	
6-30	13 (6-8-10-12-14-16-18-20-22-24-26-28-30)	10	99	67368	
6-38	12 (6-9-13-16-19-21-23-26-29-32-35-38)	12	97	69557	



Set 3 Pcs

Cont.	Nº Art.	€
4-12, 4-20, 6-30 mm	67357	

Línea 33 cm - Ref. 1612



∅	4-12	4-20	6-30	6-38
Pcs	1	1	1	1

Ref. 4995 - Nº Art. 70958: €





Ref. **1607**

BROCA ESCALONADA HSSE INOX

Stainless HSSE Step Drill Bit
Foret étagé HSSE Inox



- Nueva punta robusta autocentrante
- Avellanado especial 45°
- Menor desgaste y esfuerzo de corte
- Mayor rendimiento y vida útil de la herramienta
- Mejor evacuación de viruta
- Acabado sin rebabas

- New autocentering robust point
- Special 45° Countersinking
- Lower wear and cutting effort
- Better performance & longer tool life
- Better chipping-off
- No-burr finishing

- Nouvelle pointe plus robuste autocentrante
- Ébavurage spécial à 45°
- Réduction de l'usure et de l'effort de coupe
- Augmentation de la performance et vie utile de l'outil
- Meilleure évacuation des copeaux
- Finition sans bavures

HSSE
5% Co



Chapa
Sheets
Tôle

Materiales ferrosos
Ferrous Materials
Matériaux ferreux

Aceros
<850 N/mm²
Steel / Aciers

INOX
Stainless Steel
Acier INOX

Cobre
Copper
Cuivre

Aluminio
Aluminium

Plásticos
Plastics
Plastiques

Cap. mm	Nº Pasos Steps / Étages	d mm	L mm	Nº Art.	€
4-12	9 (4-5-6-7-8-9-10-11-12)	6	79	12072	
4-20	9 (4-6-8-10-12-14-16-18-20)	8	67	12078	
6-30	13 (6-8-10-12-14-16-18-20-22-24-26-28-30)	10	100	12084	
9-36	10 (9-12-15-18-21-24-27-30-33-36)	12	82	67299	
12-20	9 (12-13-14-15-16-17-18-19-20)	9	75	60835	
20-30	11 (20-21-22-23-24-25-26-27-28-29-30)	12	88	60837	
30-40	11 (30-31-32-33-34-35-36-37-38-39-40)	13	98	60838	
40-50	11 (40-41-42-43-44-45-46-47-48-49-50)	13	112	60839	
50-60	11 (50-51-52-53-54-55-56-57-58-59-60)	13	120	60840	



Set 3 Pcs

Cont.	Nº Art.	€
4-12, 4-20, 6-30 mm	43519	

Línea 33 cm - Ref. 1607



Ø	4-12	4-20	6-30	9-36	12-20
Pcs	1	1	1	1	1
Ref. 4995 - Nº Art. 70961:					€



Ref. **1617**

BROCA ESCALONADA **ESPIRAL** HSSE INOX

Stainless HSSE Spiral Step Drill Bit
Foret étagé spirale HSSE Inox



- Canal optimizado para virutas largas y complejas
- Avellanado especial 45°
- Filos de corte protegidos y muy afilados
- Sin rebabas
- Mayor vida útil en materiales muy duros
- Autocentrado en chapas finas
- Optimized channel for long and complex chips
- Special 45° Countersinking
- Very sharpened & protected cutting edges
- No burrs
- Longer tool life in very hard materials
- Autocentering in fine sheets
- Goujüre optimisée pour copeaux longs et complexes
- Ébavurage spécial à 45°
- Filets des arêtes de coupe protégés et plus affûtés
- Sans bavures
- Vie utile plus longue pour aciers plus durs
- Auto-centrage sur toles minces

HSSE
5% Co



Chapa
Sheets
Tôle
< 4 mm

Materiales ferrosos
Ferrous Materials
Matériaux ferreux

Aceros
<850 N/mm²
Steel / Aciers

INOX
Stainless Steel
Acier INOX

Cobre
Copper
Cuivre

Aluminio
Aluminium

Plásticos
Plastics
Plastiques

Cap. mm	Nº Pasos* Steps* / Étages*	d mm	L mm	Nº Art.	€
4-12	9 (4-5-6-7-8-9-10-11-12)	6	80	67314	
4-20	9 (4-6-8-10-12-14-16-18-20)	9	69	67316	
6-30	13 (6-8-10-12-14-16-18-20-22-24-26-28-30)	10	99	67318	



Set 3 Pcs

Cont.	Nº Art.	€
4-12, 4-20, 6-30 mm	67317	

Línea 33 cm - Ref. 1617



∅	4-12	4-20	6-30
Pcs	1	1	1

Ref. 4995 - Nº Art. 70964: €





Ref. **1603**

BROCA TUBO/CHAPA

Tube-Sheet Drill Bit
Foret ampli-trou



- Nueva geometría
- Menor desgaste, mayor vida útil de la herramienta
- Mayor velocidad de corte
- Materia prima de última generación

- New geometry
- Lower wear and longer tool life
- Higher cutting speed
- Last generation raw material

- Nouvelle Géométrie
- Réduction de l'usure, vie plus longue de l'outil
- Augmentation de la vitesse de coupe
- Matière première dernière génération



Chapa
Sheets
Tôle

Metal no ferroso
Non-Ferrous Metal
Métal non ferreux

Aceros
<850 N/mm²
Steel / Aciers

Plásticos
Plastics
Plastiques

Cap. mm	d mm	L mm	Nº Art. HSS	€	Cap. mm	d mm	L mm	Nº Art. HSS	€
3-14	6	60	12090		26-40	12	85	69922	
4-25,4	10	90	69921		36-50	12	97	12100	
5-20	8	66	69920		40-61*	13	103	12102	
8-20	8	62	69924		46-60	13	96	69923	
16-30,5	10	72	12096						



* Cap. hasta fin de existencias / while stock lasts / jusqu'à la fin de stock

Línea 33 cm - Ref. 1603



∅	3-14	4-25,4	5-20	16-30,5	36-50
Pcs	1	1	1	1	1

Ref. 4995 - Nº Art. 72084: €



Ref. **1609**

BROCA TUBO/CHAPA

Tube-Sheet Drill Bit
Foret ampli-trou



- Nueva geometría
- Menor desgaste, mayor vida útil de la herramienta
- Mayor velocidad de corte
- Materia prima de última generación

- New geometry
- Lower wear and longer tool life
- Higher cutting speed
- Last generation raw material

- Nouvelle Géométrie
- Réduction de l'usure, vie plus longue de l'outil
- Augmentation de la vitesse de coupe
- Matière Première dernière génération

HSSE 5% Co				Chapa Sheets Tôle	Metal no ferroso Non-Ferrous Metal Métal non ferreux
----------------------	--	--	--	--------------------------------	---

Aceros <850 N/mm ² Steel / Aciers	INOX Stainless Steel Acier INOX	Plásticos Plastics Plastiques
---	--	--

Cap. mm	d mm	L mm	Nº Art.	€
3-14	6	60	12108	
4-30,5	10	102	69926	
8-20	8	62	69925	
16-30,5	10	72	12111	



Línea 33 cm - Ref. 1609



∅	3-14	4-30,5	8-20	16-30,5
Pcs	1	1	1	1

Ref. 4995 - Nº Art. 72087: €



Ref. **1604**

BROCA CORTA PUNTOS SOLDADURA

Welding Point Jobber Drill Bit
Foret courte points soudure



HSSE
5% Co

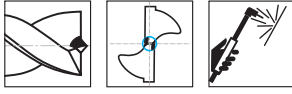

Serie Corta
Jobber Series
Série courte

D mm	L mm	I mm	N° Art.	€
6,00	66	28	16326	
8,00	80	37	16327	
10,00	89	43	66909	



Ref. 1604 zirkonio bajo demanda
upon request
sur demande



Ref. **1605**

BROCA CORTA PUNTOS SOLDADURA

Welding Point Jobber Drill Bit
Foret courte points soudure



HSSE
8% Co

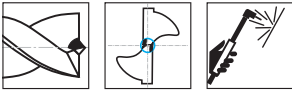

S. Extra-Corta
Stub Series
Série extra-courte

D mm	L mm	I mm	N° Art.	€
8,00	38	15	16328	
8,00	45	15	16329	
10,00	45	15	70687	



Ref. 1605 zirkonio bajo demanda
upon request
sur demande



Ref. **1606**

BROCA FRESA

Milling Drill
Foret à découper la tôle



HSS



D mm	L mm	N° Art.	€
6,00	90	16330	
8,00	95	16331	





Ref. **1610**

BROCA-MACHO-AVELLANADOR

Combi Tap With Countersink
Outil multi-fonction

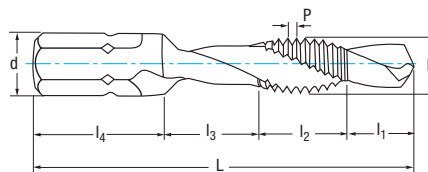

new packaging!

HSS

DIN 3126



Aceros <850 N/mm²
Steel / Aciers

D mm	L mm	l1 mm	l2 mm	l3 mm	l4 mm	d mm	P	Avellanado Countersinking Fraisage mm	Nº Art.	€
M3	36	5	8	7	12	6,35	0,50	7,00	1	12567
M4	39	5	11	8	12	6,35	0,70	7,00	1	12571
M5	41	7	11	9	12	6,35	0,80	7,00	1	12577
M6	44	8	11	10	12	6,35	1,00	7,00	1	10971
M8	50	11	15	10	12	6,35	1,25	9,00	1	12582
M10	59	12	21	10	12	6,35	1,50	11,00	1	12583



Set 7 Pcs

Cont. Ø	Nº Art.	€
M3-M4-M5-M6-M8-M10-Adapt.	11025	



Ref. **1614**

New!



Pag. 336



BROCA-MACHO-AVELLANADOR MANGO E6.3
E6.3 Shank Combi Tap with Countersink
Outil multi-fonction queue E6.3

Línea 33 cm - Ref. 1610



ø	M3	M4	M5	M6	M8
Pcs	2	2	2	2	2

Ref. 4995 - Nº Art. 72199: €



FRESAS HUECAS M. ELECTROMAGNÉTICAS
Annular Cutter Core Drills
Fraises à carotter UP électromagnétiques

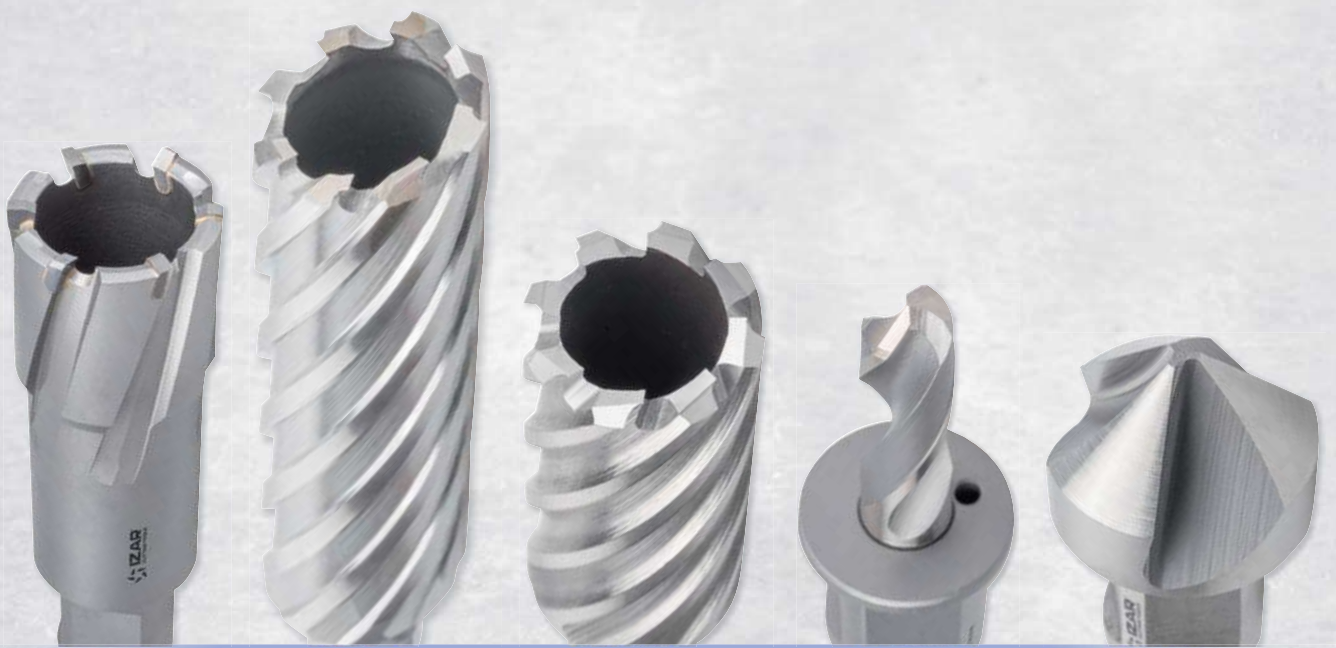

Ref. 4078

FRESA HUECA MÁQUINAS ELECTROMAGNÉTICAS TCT CORTA

Short TCT Annular Cutter Core Drill

Fraise à carotter pour unité de perçage électromagnétique TCT courte

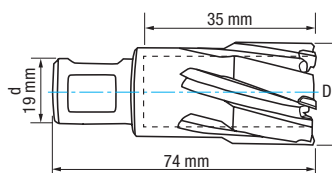

MD/HM
TCT

Serie Corta
Jobber Series
Série courte

Apto con Poca Lubricación
Suitable with Minimal Cooling
Apte avec lubrification minimale

DOBLE
WELDON

Aceros
<850 N/mm²
Steel / Aciers

INOX
Stainless Steel
Acier INOX

Fundición
Cast Iron
Fonte

Cobre
Copper
Cuivre

Latón
Brass
Laiton

Madera
Wood
Bois



D mm	d mm	L mm	I mm	Nº Art.	€	D mm	d mm	L mm	I mm	Nº Art.	€	D mm	d mm	L mm	I mm	Nº Art.	€
14	19	74	35	61963		30	19	74	35	61980		46	19	74	35	61996	
15	19	74	35	61964		31	19	74	35	61981		47	19	74	35	61997	
16	19	74	35	61965		32	19	74	35	61982		48	19	74	35	61998	
17	19	74	35	61966		33	19	74	35	61983		49	19	74	35	61999	
18	19	74	35	61967		34	19	74	35	61984		50	19	74	35	62000	
19	19	74	35	61968		35	19	74	35	61985		51	19	74	35	62001	
20	19	74	35	61969		36	19	74	35	61986		52	19	74	35	62002	
21	19	74	35	61970		37	19	74	35	61987		53	19	74	35	62003	
22	19	74	35	61971		38	19	74	35	61988		54	19	74	35	62004	
23	19	74	35	61973		39	19	74	35	61989		55	19	74	35	62005	
24	19	74	35	61974		40	19	74	35	61990		56	19	74	35	62006	
25	19	74	35	61975		41	19	74	35	61991		57	19	74	35	62007	
26	19	74	35	61976		42	19	74	35	61992		58	19	74	35	62008	
27	19	74	35	61977		43	19	74	35	61993		59	19	74	35	62009	
28	19	74	35	61978		44	19	74	35	61994		60	19	74	35	62010	
29	19	74	35	61979		45	19	74	35	61995							

Línea 33 cm - Ref. 4078



∅	14	16	18	20	22
Pcs	2	2	2	2	2

Ref. 4995 - Nº Art. 70967: €

Ref. 4075

EXPULSORES

Pilot Pins

Ejecteurs



D mm	L mm	Cap. mm	Para/For/Pour Ref.	Nº Art.	€
6,34	90	12-17	4078 (35 mm)	65905	
* 6,34	116	12-17	4078 (35 mm)	71750	
7,98	90	18-60	4078 (35 mm)	65907	
* 7,98	118	18-60	4078 (35 mm)	71880	

HSS

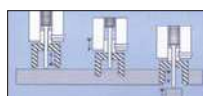

* Para uso con adaptador
When using with adapter / Pour usage avec adaptateur





Ref. **4077**

FRESA HUECA MÁQUINAS ELECTROMAGNÉTICAS TCT LARGA

Long TCT Annular Cutter Core Drill

Fraise à carotter pour unité de perçage électromagnétique TCT longue

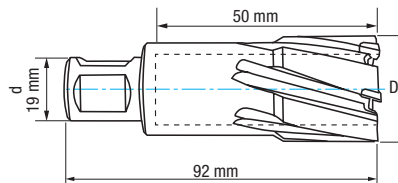

MD/HM
TCT

Serie Larga
Long Length
Série longue

Apto con Poca Lubricación
Suitable with Minimal Cooling
Apte avec lubrification minimale

DOBLE
WELDON

Aceros
<850 N/mm²
Steel / Aciers

INOX
Stainless Steel
Acier INOX

Fundición
Cast Iron
Fonte

Cobre
Copper
Cuivre

Latón
Brass
Laiton

Madera
Wood
Bois



D mm	d mm	L mm	I mm	Nº Art.	€
14	19	92	50	56746	
15	19	92	50	56747	
16	19	92	50	56749	
17	19	92	50	56750	
18	19	92	50	56752	
19	19	92	50	56753	
20	19	92	50	56754	
21	19	92	50	56755	
22	19	92	50	56756	
23	19	92	50	56757	
24	19	92	50	56758	
25	19	92	50	56759	
26	19	92	50	56760	
27	19	92	50	56761	
28	19	92	50	56762	
29	19	92	50	56763	

D mm	d mm	L mm	I mm	Nº Art.	€
30	19	92	50	56764	
31	19	92	50	56765	
32	19	92	50	56766	
33	19	92	50	56767	
34	19	92	50	56768	
35	19	92	50	56769	
36	19	92	50	56770	
37	19	92	50	56771	
38	19	92	50	56772	
39	19	92	50	56773	
40	19	92	50	56774	
41	19	92	50	56775	
42	19	92	50	56776	
43	19	92	50	56777	
44	19	92	50	56778	
45	19	92	50	56779	

D mm	d mm	L mm	I mm	Nº Art.	€
46	19	92	50	56780	
47	19	92	50	56781	
48	19	92	50	56782	
49	19	92	50	56783	
50	19	92	50	56784	
51	19	92	50	56785	
52	19	92	50	56786	
53	19	92	50	56787	
54	19	92	50	56788	
55	19	92	50	56789	
56	19	92	50	56790	
57	19	92	50	56791	
58	19	92	50	56792	
59	19	92	50	56793	
60	19	92	50	56794	

Línea 33 cm - Ref. 4077



Ø	14	16	18	20	22
Pcs	2	2	2	2	2

Ref. 4995 - Nº Art. 70970: €

Ref. **4075**

EXPULSORES

Pilot Pins

Ejecteurs



HSS

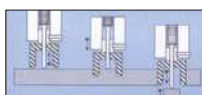

D mm	L mm	Cap. mm	Para/For/Pour Ref.	Nº Art.	€
6,34	106	12-17	4077 (50 mm)	61501	
* 6,34	127	12-17	4077 (50 mm)	71878	
7,98	105	18-60	4077 (50 mm)	61503	
* 7,98	130	18-60	4077 (50 mm)	71883	

* Para uso con adaptador
When using with adapter / Pour usage avec adaptateur



Ref. **4070**

FRESA HUECA MÁQUINAS ELECTROMAGNÉTICAS HSS-XT CORTA

Short HSS-XT Annular Cutter Core Drill

Fraise à carotter pour unité de perçage électromagnétique HSS-XT courte

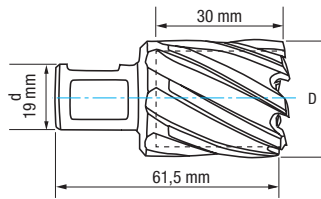

HSS-XT	Serie Corta Jobber Series Série courte	Aceros Construcción Structural Steels Aciers de construction	Apto con Poca Lubricación Suitable with Minimal Cooling Apte avec lubrification minimale	DOBLE WELDON
--------	---	---	---	-----------------

Aceros <850 N/mm ² Steel / Aciers	Aceros <1000 N/mm ² Steel / Aciers	Fundición Cast Iron Fonte
---	--	--



D mm	d mm	L mm	l mm	Nº Art.	€	D mm	d mm	L mm	l mm	Nº Art.	€
12	19	61,5	30	21106		37	19	61,5	30	21131	
13	19	61,5	30	21107		38	19	61,5	30	21132	
14	19	61,5	30	21108		39	19	61,5	30	21133	
15	19	61,5	30	21109		40	19	61,5	30	21134	
16	19	61,5	30	21110		41	19	61,5	30	21135	
17	19	61,5	30	21111		42	19	61,5	30	21136	
18	19	61,5	30	21112		43	19	61,5	30	21137	
19	19	61,5	30	21113		44	19	61,5	30	21138	
20	19	61,5	30	21114		45	19	61,5	30	21139	
21	19	61,5	30	21115		46	19	61,5	30	21140	
22	19	61,5	30	21116		47	19	61,5	30	21141	
23	19	61,5	30	21117		48	19	61,5	30	21142	
24	19	61,5	30	21118		49	19	61,5	30	21143	
25	19	61,5	30	21119		50	19	61,5	30	21144	
26	19	61,5	30	21120		51	19	61,5	30	21145	
27	19	61,5	30	21121		52	19	61,5	30	21146	
28	19	61,5	30	21122		53	19	61,5	30	21147	
29	19	61,5	30	21123		54	19	61,5	30	21148	
30	19	61,5	30	21124		55	19	61,5	30	21149	
31	19	61,5	30	21125		56	19	61,5	30	21150	
32	19	61,5	30	21126		57	19	61,5	30	21151	
33	19	61,5	30	21127		58	19	61,5	30	21152	
34	19	61,5	30	21128		59	19	61,5	30	21153	
35	19	61,5	30	21129		60	19	61,5	30	21154	
36	19	61,5	30	21130							



Set 6 Pcs

Cont. Ø	Nº Art.	€
12-14-16-18-20-22	66858	



Set 5 Pcs

Cont. Ø	Nº Art.	€
24-26-28-30-32	66859	

Línea 33 cm - Ref. 4070



Ø	14	16	18	20	22
Pcs	2	2	2	2	2

Ref. 4995 - Nº Art. 70974: €

Ref. **4075**

EXPULSORES

Pilot Pins
Ejecteurs

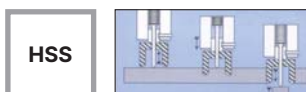

HSS

D mm	L mm	Para/For/Pour Ref.	Nº Art.	€
6,34	77	4070 (30 mm)	61502	
* 6,34	102	4070 (30 mm)	61500	

* Para uso con adaptador
When using with adapter
Pour usage avec adaptateur





Ref. **4071**

FRESA HUECA MÁQUINAS ELECTROMAGNÉTICAS HSS-XT LARGA

Long HSS-XT Annular Cutter Core Drill

Fraise à carotter pour unité de perçage électromagnétique HSS-XT longue

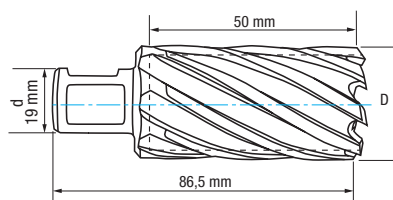

HSS-XT	Serie Larga Long Length Série longue	Aceros Construcción Structural Steels Aciers de construction	Apto con Poca Lubricación Suitable with Minimal Cooling Apte avec lubrification minimale	Rectificado Ground Taillé meulé	DOBLE WELDON
--------	---	---	---	--	-----------------

Aceros <850 N/mm ² Steel / Aciers	Aceros <1000 N/mm ² Steel / Aciers	Fundición Cast Iron Fonte	Aluminio Aluminium
---	--	--	------------------------------



D mm	d mm	L mm	l mm	Nº Art.	€	D mm	d mm	L mm	l mm	Nº Art.	€	D mm	d mm	L mm	l mm	Nº Art.	€
12	19	86,5	50	73338		28	19	86,5	50	21171		45	19	86,5	50	21189	
13	19	86,5	50	73339		29	19	86,5	50	21172		46	19	86,5	50	21190	
14	19	86,5	50	21157		30	19	86,5	50	21173		47	19	86,5	50	21191	
15	19	86,5	50	21158		31	19	86,5	50	21174		48	19	86,5	50	21192	
16	19	86,5	50	21159		32	19	86,5	50	21175		49	19	86,5	50	21193	
17	19	86,5	50	21160		33	19	86,5	50	21177		50	19	86,5	50	21194	
18	19	86,5	50	21161		34	19	86,5	50	21178		51	19	86,5	50	21195	
19	19	86,5	50	21162		35	19	86,5	50	21179		52	19	86,5	50	21196	
20	19	86,5	50	21163		36	19	86,5	50	21180		53	19	86,5	50	21197	
21	19	86,5	50	21164		37	19	86,5	50	21181		54	19	86,5	50	21198	
22	19	86,5	50	21165		38	19	86,5	50	21182		55	19	86,5	50	21199	
23	19	86,5	50	21166		39	19	86,5	50	21183		56	19	86,5	50	21200	
24	19	86,5	50	21167		40	19	86,5	50	21184		57	19	86,5	50	21201	
25	19	86,5	50	21168		41	19	86,5	50	21185		58	19	86,5	50	21202	
26	19	86,5	50	21169		42	19	86,5	50	21186		59	19	86,5	50	21203	
27	19	86,5	50	21170		43	19	86,5	50	21187		60	19	86,5	50	21204	
						44	19	86,5	50	21188							

Línea 33 cm - Ref. 4071



∅	14	16	18	20	22
Pcs	2	2	2	2	2

Ref. 4995 - Nº Art. 70978: €

Ref. **4075**

EXPULSORES

Pilot Pins

Ejecteurs



HSS

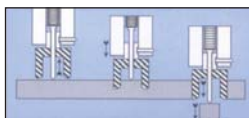

D mm	L mm	Para/For/Pour Ref.	Nº Art.	€
6,34	102	4071 (50 mm)	61500	
* 6,34	127	4071 (50 mm)	71878	

* Para uso con adaptador
When using with adapter / Pour usage avec adaptateur



Ref. **4072**

FRESA HUECA MÁQUINAS ELECTROMAGNÉTICAS HSS-XT EXTRA LARGA

Extra Long HSS-XT Annular Cutter Core Drill

Fraise à carotter pour unité de perçage électromagnétique HSS-XT extra-longue

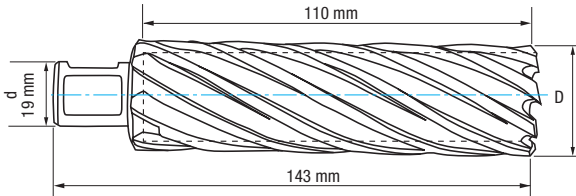

HSS-XT	Serie Extra-Larga Extra-Long Series Série extra-longue	Aceros Construcción Structural Steels Aciers de construction	Apto con Poca Lubricación Suitable with Minimal Cooling Apte avec lubrification minimale	DOBLE WELDON
--------	---	---	---	-----------------

Aceros <850 N/mm ² Steel / Aciers	Aceros <1000 N/mm ² Steel / Aciers	Fundición Cast Iron Fonte	Aluminio Aluminium
---	--	--	------------------------------



D mm	d mm	L mm	I mm	Nº Art.	€	D mm	d mm	L mm	I mm	Nº Art.	€	D mm	d mm	L mm	I mm	Nº Art.	€
20	19	143	110	56694		31	19	143	110	56706		42	19	143	110	56718	
21	19	143	110	56695		32	19	143	110	56707		43	19	143	110	56719	
22	19	143	110	56696		33	19	143	110	56708		44	19	143	110	56721	
23	19	143	110	56697		34	19	143	110	56709		45	19	143	110	56722	
24	19	143	110	56698		35	19	143	110	56710		46	19	143	110	56724	
25	19	143	110	56699		36	19	143	110	56711		47	19	143	110	56725	
26	19	143	110	56700		37	19	143	110	56712		48	19	143	110	56727	
27	19	143	110	56701		38	19	143	110	56714		49	19	143	110	56728	
28	19	143	110	56702		39	19	143	110	56715		50	19	143	110	56730	
29	19	143	110	56703		40	19	143	110	56716							
30	19	143	110	56704		41	19	143	110	56717							

Línea 33 cm - Ref. 4072



∅	20	22	26	32	40
Pcs	1	1	1	1	1

Ref. 4995 - Nº Art. 72090: €

Ref. **4075**

EXPULSORES

Pilot Pins

Ejecteurs



HSS

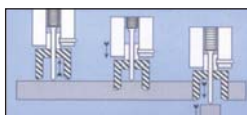

D mm	L mm	Para/For/Pour Ref.	Nº Art.	€
7,98	154	4072 (110 mm)	61504	
* 7,98	180	4072 (110 mm)	71885	

* Para uso con adaptador
When using with adapter
Pour usage avec adaptateur





Ref. **4079**

BROCA MÁQUINAS ELECTROMAGNÉTICAS HSS-XT

HSS-XT Solid Drill

Foret pour unité de perçage électromagnétique HSS-XT

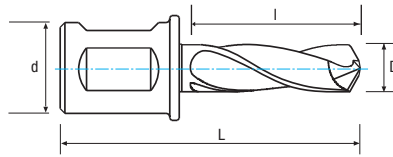

HSS-XT	Serie Corta Jobber Series Série courte	Aceros Construcción Structural Steels Aciers de construction	Apto con Poca Lubricación Suitable with Minimal Cooling Apte avec lubrification minimale	DOBLE WELDON
---------------	---	---	---	---------------------

Aceros <850 N/mm ² Steel / Aciers	Aceros <1000 N/mm ² Steel / Aciers	Fundición Cast Iron Fonte
---	--	--

D mm	d mm	L mm	l mm	Nº Art.	€
6	19	63	25	69758	
8	19	63	25	69761	
10	19	63	25	69763	
12	19	63	25	69768	
14	19	63	25	69769	



Línea 33 cm - Ref. 4079



∅	6	8	10	12	14
Pcs	1	1	1	1	1

Ref. 4995 - Nº Art. 70982: €

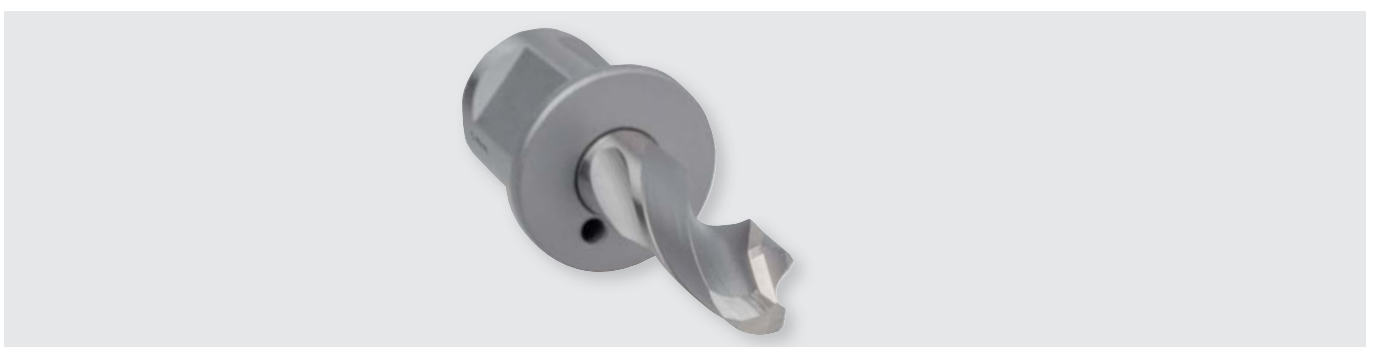

Ref. **4076**

AVELLANADOR MÁQUINA ELECTROMAGNÉTICA HSS-XT

HSS-XT Annular Cutter Core Drill Countersink

Fraise à noyer pour unité de perçage électromagnétique HSS-XT

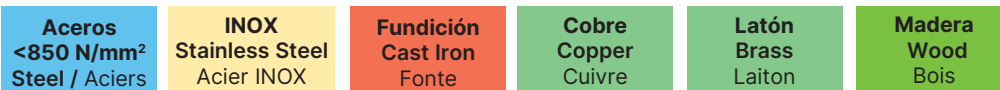
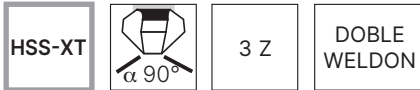

D+ mm	D- mm	d mm	L mm	Nº Art.	€
25	3	19	45	61505	
30	3	19	47	61506	
40	3	19	52	61507	
50	3	19	57	61508	
55	3	19	60	61509	



Línea 33 cm - Ref. 4076



∅	25	30	40	50	55
Pcs	1	1	1	1	1

Ref. 4995 - Nº Art. 72093: €





Ref. **4074**

ADAPTADOR FRESA HUECA MÁQUINA ELECTROMAGNÉTICA

Annular Cutter Core Drill Adaptor

Adaptateur pour fraise à carotter pour unité de perçage électromagnétique



Fresa Cutter Fraise	Máquina Machine	Expulsor mm Pilot Pin Ejecteur	L mm	I mm	Nº Art.	€
Doble Weldon	Fein Quick In	6,35	51,20	28,60	61510	
Doble Weldon	Fein Quick In	7,98	51,20	28,60	61511	



Fresa Cutter Fraise	Máquina Machine	Expulsor mm Pilot Pin Ejecteur	L mm	I mm	Nº Art.	€
Doble Weldon	Universal	6,35	51,20	28,60	61512	
Doble Weldon	Universal	7,98	51,20	28,60	61513	



Entrada In Entrée	Salida Out Sortie	L mm	Nº Art.	€
Doble Weldon	1/2x20h	43	83450	



Entrada In Entrée	Salida Out Sortie	L mm	Nº Art.	€
Doble Weldon	B16	57	83449	

Ref. **4073**

CONO PORTA FRESAS HUECAS

Holder for annular cutters

Cône pour porte-fraise à carotter pour unité de perçage électromagnétique

New!

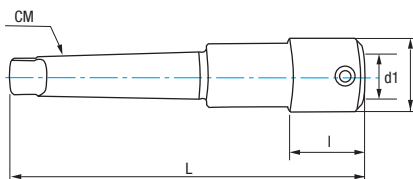

CM	D mm	L mm	I mm	d1 mm	Nº Art.	€
2	37	165	37	19	84115	
3	37	175	37	19	84116	



Llave Allen incluida

Allen key included









Clé Allen incluse



ELECCIÓN ADAPTADORES FRESAS HUECAS DOBLE WELDON

Double Weldon Annular Cutter Core Drill Adaptor Choice

Choix d'adaptateurs pour fraises à carotter Double Weldon

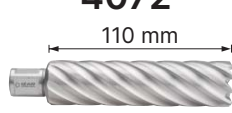
Ref. 4075		Ref. 4074		Ref. 4075	
Fresa Cutter Fraise	Expulsor sin Adaptador Pilot Pin without adapter Ejecteur sans adaptateur	Adaptador Máquina Adaptor Machine Adaptateur machine	FEIN QUICK IN	* Expulsor para uso con adaptador * Pilot Pin when using with Adapter * Ejecteur pour usage avec adaptateur	
4078 	(12-17 mm) 6,34 × 90 mm. Art. 65905	 Art. 61510		(12-17 mm) * 6,34 × 116 mm. Art. 71750	
4077 	(12-17 mm) 6,34 × 106 mm. Art. 61501			(12-17 mm) * 6,34 × 127 mm. Art. 71878	
4070 	6,34 × 77 mm. Art. 61502			* 6,34 × 102 mm. Art. 61500	
4071 	6,34 × 102 mm. Art. 61500			* 6,34 × 127 mm. Art. 71878	
4078 	(18-60 mm) 7,98 × 90 mm. Art. 65907			 Art. 61511	
4077 	(18-60 mm) 7,98 × 105 mm. Art. 61503	(18-60 mm) * 7,98 × 130 mm. Art. 71883			
4072 	7,98 × 154 mm. Art. 61504	* 7,98 × 180 mm. Art. 71885			









ELECCIÓN ADAPTADORES FRESAS HUECAS DOBLE WELDON

Double Weldon Annular Cutter Core Drill Adaptor Choice

Choix d'adaptateurs pour fraises à carotter Double Weldon

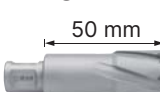
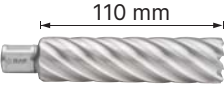

Ref. 4075		Ref. 4074		Ref. 4075			
Fresa Cutter Fraise	Expulsor sin Adaptador Pilot Pin without adapter Ejecteur sans adaptateur	Adaptador Máquina Adaptor Machine Adaptateur machine	UNIVERSAL Nitto + Weldon	* Expulsor para uso con adaptador * Pilot Pin when using with Adapter * Ejecteur pour usage avec adaptateur			
4078 	(12-17 mm) 6,34 × 90 mm. Art. 65905	 Art. 61512		(12-17 mm) * 6,34 × 116 mm. Art. 71750			
4077 	(12-17 mm) 6,34 × 106 mm. Art. 61501			(12-17 mm) * 6,34 × 127 mm. Art. 71878			
4070 	6,34 × 77 mm. Art. 61502			* 6,34 × 102 mm. Art. 61500			
4071 	6,34 × 102 mm. Art. 61500			* 6,34 × 127 mm. Art. 71878			
4078 	(18-60 mm) 7,98 × 90 mm. Art. 65907			 Art. 61513			(18-60 mm) * 7,98 × 118 mm. Art. 71880
4077 	(18-60 mm) 7,98 × 105 mm. Art. 61503						(18-60 mm) * 7,98 × 130 mm. Art. 71883
4072 	7,98 × 154 mm. Art. 61504						* 7,98 × 180 mm. Art. 71885

Ref. **4067**

FRESA HUECA MÁQUINAS ELECTROMAGNÉTICAS TCT LARGA

Long TCT Annular Cutter Core Drill

Fraise à carotter pour unité de perçage électromagnétique TCT longue

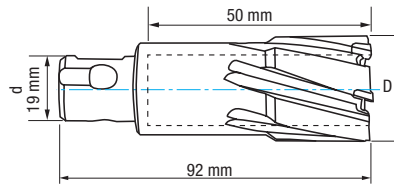

MD/HM
TCT

Serie Larga
Long Length
Série longue

Apto con Poca Lubricación
Suitable with Minimal Cooling
Apte avec lubrification minimale

UNIVERSAL:
NITTO +
WELDON

Aceros
<850 N/mm²
Steel / Aciers

INOX
Stainless Steel
Acier INOX

Fundición
Cast Iron
Fonte

Cobre
Copper
Cuivre

Latón
Brass
Laiton

Madera
Wood
Bois



D mm	d mm	L mm	I mm	Nº Art.	€	D mm	d mm	L mm	I mm	Nº Art.	€	D mm	d mm	L mm	I mm	Nº Art.	€
14	19	92	50	61248		30	19	92	50	61264		46	19	92	50	61280	
15	19	92	50	61249		31	19	92	50	61265		47	19	92	50	61281	
16	19	92	50	61250		32	19	92	50	61266		48	19	92	50	61282	
17	19	92	50	61251		33	19	92	50	61267		49	19	92	50	61283	
18	19	92	50	61252		34	19	92	50	61268		50	19	92	50	61199	
19	19	92	50	61253		35	19	92	50	61269		51	19	92	50	61284	
20	19	92	50	61254		36	19	92	50	61270		52	19	92	50	61285	
21	19	92	50	61255		37	19	92	50	61271		53	19	92	50	61286	
22	19	92	50	61256		38	19	92	50	61272		54	19	92	50	61287	
23	19	92	50	61257		39	19	92	50	61273		55	19	92	50	61288	
24	19	92	50	61258		40	19	92	50	61274		56	19	92	50	61289	
25	19	92	50	61259		41	19	92	50	61275		57	19	92	50	61290	
26	19	92	50	61260		42	19	92	50	61276		58	19	92	50	61291	
27	19	92	50	61261		43	19	92	50	61277		59	19	92	50	61292	
28	19	92	50	61262		44	19	92	50	61278		60	19	92	50	61293	
29	19	92	50	61263		45	19	92	50	61279							

Línea 33 cm - Ref. 4067



∅	14	16	18	20	22
Pcs	2	2	2	2	2
Ref. 4995 - Nº Art. 72096:	€				

Ref. **4075**

EXPULSORES

Pilot Pins

Ejecteurs



HSS

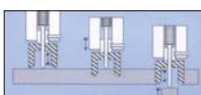

D mm	L mm	Cap. mm	Para/For/Pour Ref.	Nº Art.	€
6,34	106	12-17	4067 (50 mm)	61501	
7,98	105	18-60	4067 (50 mm)	61503	



Ref. **4060**

FRESA HUECA MÁQUINAS ELECTROMAGNÉTICAS HSS-XT CORTA

Short HSS-XT Annular Cutter Core Drill

Fraise à carotter pour unité de perçage électromagnétique HSS-XT courte

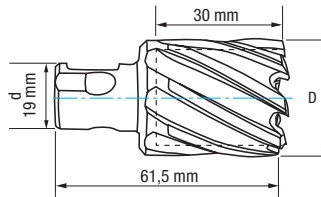

HSS-XT	Serie Corta Jobber Series Série courte	Aceros Construcción Structural Steels Aciers de construction	Apto con Poca Lubricación Suitable with Minimal Cooling Apte avec lubrification minimale	UNIVERSAL: NITTO + WELDON
--------	---	---	---	---------------------------------

Aceros <850 N/mm ² Steel / Aciers	Aceros <1000 N/mm ² Steel / Aciers	Fundición Cast Iron Fonte	Aluminio Aluminium
---	--	--	------------------------------



D mm	d mm	L mm	I mm	Nº Art.	€	D mm	d mm	L mm	I mm	Nº Art.	€
12	19	61,5	30	61120		37	19	61,5	30	61145	
13	19	61,5	30	61121		38	19	61,5	30	61146	
14	19	61,5	30	61122		39	19	61,5	30	61147	
15	19	61,5	30	61123		40	19	61,5	30	61148	
16	19	61,5	30	61124		41	19	61,5	30	61149	
17	19	61,5	30	61125		42	19	61,5	30	61150	
18	19	61,5	30	61126		43	19	61,5	30	61151	
19	19	61,5	30	61127		44	19	61,5	30	61152	
20	19	61,5	30	61128		45	19	61,5	30	61153	
21	19	61,5	30	61129		46	19	61,5	30	61154	
22	19	61,5	30	61130		47	19	61,5	30	61155	
23	19	61,5	30	61131		48	19	61,5	30	61156	
24	19	61,5	30	61132		49	19	61,5	30	61157	
25	19	61,5	30	61133		50	19	61,5	30	61158	
26	19	61,5	30	61134		51	19	61,5	30	61159	
27	19	61,5	30	61135		52	19	61,5	30	61160	
28	19	61,5	30	61136		53	19	61,5	30	61161	
29	19	61,5	30	61137		54	19	61,5	30	61162	
30	19	61,5	30	61138		55	19	61,5	30	61163	
31	19	61,5	30	61139		56	19	61,5	30	61164	
32	19	61,5	30	61140		57	19	61,5	30	61165	
33	19	61,5	30	61141		58	19	61,5	30	61166	
34	19	61,5	30	61142		59	19	61,5	30	61167	
35	19	61,5	30	61143		60	19	61,5	30	61168	
36	19	61,5	30	61144							



Set 6 Pcs

Cont. Ø	Nº Art.	€
12-14-16-18-20-22	66860	



Set 5 Pcs

Cont. Ø	Nº Art.	€
24-26-28-30-32	66861	

Línea 33 cm - Ref. 4060



Ø	14	16	18	20	22
Pcs	2	2	2	2	2
Ref. 4995 - Nº Art. 72099:					€

Ref. **4075**

EXPULSORES

Pilot Pins
Ejecteurs



D mm	L mm	Para/For/Pour Ref.	Nº Art.	€
6,34	77	4060 (30 mm)	61502	





Ref. **4061**

FRESA HUECA MÁQUINAS ELECTROMAGNÉTICAS HSS-XT LARGA

Long HSS-XT Annular Cutter Core Drill

Fraise à carotter pour unité de perçage électromagnétique HSS-XT longue

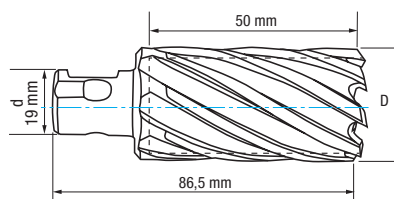

HSS-XT	Serie Larga Long Length Série longue	Aceros Construcción Structural Steels Aciers de construction	Apto con Poca Lubricación Suitable with Minimal Cooling Apte avec lubrification minimale	Rectificado Ground Taillé meulé	UNIVERSAL: NITTO + WELDON
---------------	---	---	---	--	--

Aceros <850 N/mm ² Steel / Aciers	Aceros <1000 N/mm ² Steel / Aciers	Fundición Cast Iron Fonte	Aluminio Aluminium
---	--	--	------------------------------



D mm	d mm	L mm	l mm	Nº Art.	€	D mm	d mm	L mm	l mm	Nº Art.	€	D mm	d mm	L mm	l mm	Nº Art.	€
12	19	86,5	50	73340		28	19	86,5	50	61183		45	19	86,5	50	61201	
13	19	86,5	50	73342		29	19	86,5	50	61184		46	19	86,5	50	61202	
14	19	86,5	50	61169		30	19	86,5	50	61185		47	19	86,5	50	61203	
15	19	86,5	50	61170		31	19	86,5	50	61186		48	19	86,5	50	61204	
16	19	86,5	50	61171		32	19	86,5	50	61187		49	19	86,5	50	61205	
17	19	86,5	50	61172		33	19	86,5	50	61188		50	19	86,5	50	61206	
18	19	86,5	50	61173		34	19	86,5	50	61189		51	19	86,5	50	61207	
19	19	86,5	50	61174		35	19	86,5	50	61190		52	19	86,5	50	61208	
20	19	86,5	50	61175		36	19	86,5	50	61191		53	19	86,5	50	61209	
21	19	86,5	50	61176		37	19	86,5	50	61192		54	19	86,5	50	61210	
22	19	86,5	50	61177		38	19	86,5	50	61193		55	19	86,5	50	61211	
23	19	86,5	50	61178		39	19	86,5	50	61194		56	19	86,5	50	61212	
24	19	86,5	50	61179		40	19	86,5	50	61195		57	19	86,5	50	61213	
25	19	86,5	50	61180		41	19	86,5	50	61196		58	19	86,5	50	61214	
26	19	86,5	50	61181		42	19	86,5	50	61197		59	19	86,5	50	61215	
27	19	86,5	50	61182		43	19	86,5	50	61198		60	19	86,5	50	61216	
						44	19	86,5	50	61200							

Línea 33 cm - Ref. 4061

19 cm

∅	14	16	18	20	22
Pcs	2	2	2	2	2

Ref. 4995 - Nº Art. 72105: €

Ref. **4075**

EXPULSORES

Pilot Pins
Ejecteurs



HSS

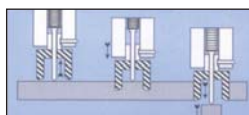

D mm	L mm	Para/For/Pour Ref.	Nº Art.	€
6,34	102	4061 (50 mm)	61500	



Ref. **4062**

FRESA HUECA MÁQUINAS ELECTROMAGNÉTICAS HSS-XT EXTRA LARGA

Extra Long HSS-XT Annular Cutter Core Drill

Fraise à carotter pour unité de perçage électromagnétique HSS-XT extra-longue

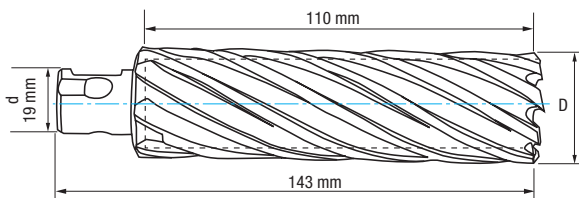

HSS-XT	Serie Extra-Larga Extra-Long Series Série extra-longue	Aceros Construcción Structural Steels Aciers de construction	Apto con Poca Lubricación Suitable with Minimal Cooling Apte avec lubrification minimale	UNIVERSAL: NITTO + WELDON
---------------	---	---	---	--

Aceros <850 N/mm ² Steel / Aciers	Aceros <1000 N/mm ² Steel / Aciers	Fundición Cast Iron Fonte	Aluminio Aluminium
---	--	--	------------------------------



D mm	d mm	L mm	I mm	Nº Art.	€	D mm	d mm	L mm	I mm	Nº Art.	€	D mm	d mm	L mm	I mm	Nº Art.	€
20	19	143	110	61217		31	19	143	110	61228		42	19	143	110	61239	
21	19	143	110	61218		32	19	143	110	61229		43	19	143	110	61240	
22	19	143	110	61219		33	19	143	110	61230		44	19	143	110	61241	
23	19	143	110	61220		34	19	143	110	61231		45	19	143	110	61242	
24	19	143	110	61221		35	19	143	110	61232		46	19	143	110	61243	
25	19	143	110	61222		36	19	143	110	61233		47	19	143	110	61244	
26	19	143	110	61223		37	19	143	110	61234		48	19	143	110	61245	
27	19	143	110	61224		38	19	143	110	61235		49	19	143	110	61246	
28	19	143	110	61225		39	19	143	110	61236		50	19	143	110	61247	
29	19	143	110	61226		40	19	143	110	61237							
30	19	143	110	61227		41	19	143	110	61238							

Línea 33 cm - Ref. 4062



25 cm

Ø	20	22	26	32	40
Pcs	1	1	1	1	1

Ref. 4995 - Nº Art. 72108: €

Ref. **4075**

EXPULSORES

Pilot Pins

Ejecteurs

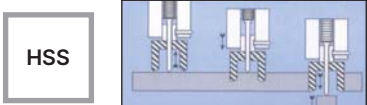

HSS	D mm	L mm	Para/For/Pour Ref.	Nº Art.	€
	7,98	154	4062 (110 mm)	61504	



CORONAS

Hole Saws

Trépan

Ref. **1667**

CORONA REAFILABLE HSS

HSS Resharpenable Hole Saw
Fraise réaffûtable HSS

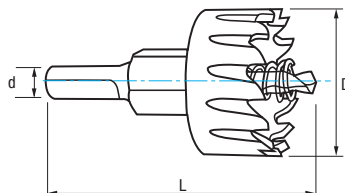

HSS



Aceros
<850 N/mm²
Steel / Aciers

Fundición
Cast Iron
Fonte

Cobre
Copper
Cuivre

Latón
Brass
Laiton

Aluminio
Aluminium

Madera
Wood
Bois



D mm	d mm	L mm	D mm Broca Drill Bit Foret	Nº Art.	€
12	10	75,50	6	56569	
13	10	75,50	6	56570	
14	10	75,50	6	56572	
15	10	75,50	6	56573	
16	10	75,50	6	56152	
17	10	75,50	6	56576	
18	10	75,50	6	56578	
19	10	75,50	6	56579	
20	10	75,50	6	56154	
21	10	75,50	6	56582	
22	10	75,50	6	56155	
23	10	75,50	6	56583	
24	10	75,50	6	56584	
25	10	75,50	6	56156	
26	10	75,50	6	56585	
27	10	75,50	6	56157	
28	10	75,50	6	56587	
29	10	75,50	6	56588	
30	10	75,50	6	56158	
32	10	75,50	6	56159	

D mm	d mm	L mm	D mm Broca Drill Bit Foret	Nº Art.	€
33	10	75,50	6	56590	
35	10	75,50	6	56160	
36	10	75,50	6	56591	
38	10	75,50	6	56593	
39	10	75,50	6	56594	
40	10	75,50	6	56161	
42	10	75,50	6	56596	
45	10	75,50	6	56597	
48	10	75,50	6	56163	
49	10	75,50	6	68602	
50	10	75,50	6	56164	
51	10	75,50	6	68604	
53	10	75,50	6	56599	
55	10	75,50	6	56600	
60	10	75,50	6	56165	
63	10	75,50	6	68605	
65	10	75,50	6	56602	
68	10	75,50	6	68607	
70	10	75,50	6	56166	
75	10	75,50	6	56167	

D mm	d mm	L mm	D mm Broca Drill Bit Foret	Nº Art.	€
76	10	75,50	6	68608	
80	10	75,50	6	56603	
85	10	75,50	6	56605	
90	10	75,50	6	56606	
100	10	75,50	6	56608	

* Broca y muelle incluidos
Drill Bit & Spring included
Foret et ressort inclus



Set 6 Pcs

Cont. Ø	Nº Art.	€
12-14-16-18-20-22	77448	

TIN

Bajo demanda / upon request / sur demande

Ref. **1664**



Broca / Drill Bit / Foret

D mm	L mm	Cap.	Nº Art.	€ 1 ud.
5	48	12-15	83478	
6	48	16-100	60704	



Muelle / Spring / Ressort

D mm	L mm	Box	Nº Art.	€ pack
8,5	20	10	60637	
8,5	35	10	60638	



Expo - Ref. 1667

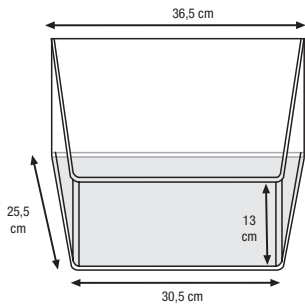

31 Pcs

N° Art. €
66804

Diam.	N° Art.	Uds.	Diam.	N° Art.	Uds.
12	56569	1	28	56587	1
13	56570	1	29	56588	1
14	56572	1	30	56158	1
15	56573	1	32	56159	1
16	56152	1	33	56590	1
17	56576	1	35	56160	1
18	56578	1	36	56591	1
19	56579	1	38	56593	1
20	56154	1	39	56594	1
21	56582	1	40	56161	1
22	56155	1	42	56596	1
23	56583	1	45	56597	1
24	56584	1	48	56163	1
25	56156	1	50	56164	1
26	56585	1	65	56602	1
27	56157	1			

Línea 1 m - Ref. 1667



∅	16	19	20	22	24	25	27	29	30	32	35	51	63	65
Pcs	1	1	1	1	1	1	1	1	1	1	1	1	1	1

Ref. 4995 - N° Art. 72109: €

Display 65 - Ref. 1667



∅	16	18	20	22	24	25	27	32
Pcs	1	1	1	1	1	1	1	1

Ref. 4995 - N° Art. 70083: €

Ref. **1663**

CORONA INOX ALTO RENDIMIENTO

TCT High Performance STAINLESS Hole Saw
Trépan INOX haut rendement

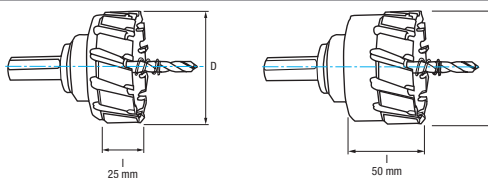

Husillo incluido
Included Spindle
Arbre compris

Broca incluida
Included Center Drill
Foret compris

Cono Morse opcional
Optional Morse Taper
Cône Morse optionel

Diente MD
Carbide Tipped
Dent carbure

PVC

Fibra Vidrio
Fiberglass
Fibre de verre

Aceros
<850 N/mm²
Steel / Aciers

Plásticos
Plastics
Plastiques

INOX
Stainless Steel
Acier INOX

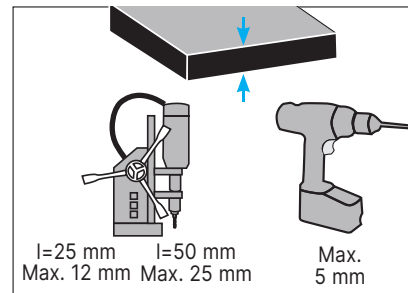
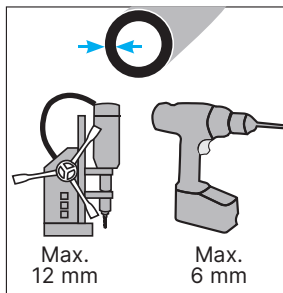

D mm	l mm	d mm	Nº Art.	€
14	25	13	71756	
15	25	13	71758	
16	25	13	71760	
17	25	13	71761	
18	25	13	71762	
19	25	13	71763	
20	25	13	71764	
21	25	13	71765	
22	25	13	71768	
23	25	13	71769	
24	25	13	71770	
25	25	13	71771	
26	25	13	71772	
27	25	13	71773	
28	25	13	71774	
29	25	13	71775	
30	25	13	71776	
31	25	13	71777	
32	25	13	71780	
33	25	13	71781	
34	25	13	71782	
35	25	13	71783	
36	25	13	71784	
37	25	13	71785	

D mm	l mm	d mm	Nº Art.	€
38	25	13	71787	
39	25	13	71788	
40	25	13	71789	
41	25	13	71790	
42	25	13	71791	
43	25	13	71792	
44	25	13	71793	
45	25	13	71794	
46	25	13	71795	
47	25	13	71796	
48	25	13	71797	
49	25	13	71798	
50	25	13	71799	
51	25	13	71800	
52	25	13	71801	
53	25	13	71802	
54	25	13	71803	
55	25	13	71804	
56	25	13	71805	
57	25	13	71806	
58	25	13	71807	
59	25	13	71808	
60	25	13	71809	

D mm	l mm	d mm	Nº Art.	€
18	50	13	71952	
20	50	13	71953	
22	50	13	71955	
25	50	13	71956	
30	50	13	71957	
35	50	13	71958	
40	50	13	71959	
45	50	13	71960	
50	50	13	71961	
55	50	13	71962	
60	50	13	71963	
65	50	13	71810	
68	50	13	71964	
70	50	13	71811	
75	50	13	71812	
80	50	13	71814	
85	50	13	71815	
90	50	13	71817	
95	50	13	71818	
100	50	13	71819	
105	50	13	71965	
110	50	13	71966	
115	50	13	71967	
120	50	13	71968	
125	50	13	71970	

Ref. **1659**

ACCESORIOS / Accessories / Accessoires



Broca Centrar *
Center Drill / Foret à centrer



Para Corona	Cap.	D	L	I	Nº	€
For Hole Saw	mm	mm	mm	mm	Art.	
Pour Trépan						
l mm						
25	14-60	6	80	30	71982	
25	61-125	8	80	30	71983	
50	14-60	6	110	55	71985	
50	61-125	8	110	55	71986	

Husillo 3 Planos *
3-Flat Spindle / Arbre 3 plans



Cap.	L	Nº	€
mm	mm	Art.	
14-60	53	71977	
61-100	53	71979	
101-125	57	71980	

Cono Morse **
Morse Taper / Cône Morse



CM	Cap.	L	Nº	€
	mm	mm	Art.	
2	16-100	108,5	71988	
3	101-125	133	71989	

* Repuesto incluido / Included Spare / Rechange compris

** Accesorio opcional / Optional Accessory / Accessoire optionel



Ref. 1665

CORONA INOX
TCT STAINLESS Hole Saw
Trépan INOX

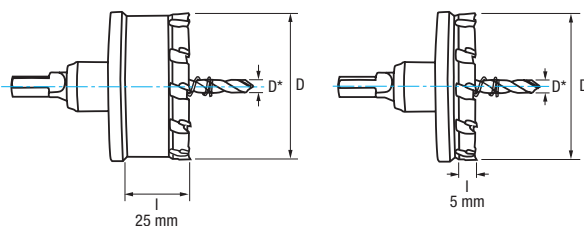

Diente MD Carbide Tipped Dent carbure	PVC	Fibra Vidrio Fiberglass Fibre de verre	l=25 mm Max. 5 mm	l=5 mm Max. 5 mm	Aceros <850 N/mm ² Steel / Aciers	INOX Stainless Steel Acier INOX	Plásticos Plastics Plastiques
--	-----	---	----------------------	---------------------	---	--	--

D mm	l mm	Pulgadas Inches Pouces	D* mm Broca Drill Bit Foret	Nº Art.	€
16	25	5/8	6	60642	
17	25	11/16	6	60643	
18	25	23/32	6	13796	
19	25	3/4	6	60645	
20	25	25/32	6	13798	
21	25	13/16	6	13799	
22	25	7/8	6	13800	
23	25	14/16	6	13801	
24	25	15/16	6	13802	
25	25	1	6	13803	
26	25	1 1/32	6	13804	
27	25	1 1/16	6	13805	
28	25	1 3/32	6	13806	
29	25	1 1/8	6	13807	
30	25	1 3/16	6	13808	
31	25	1 7/32	6	13809	
32	25	1 1/4	6	13810	
33	25	1 5/16	6	13811	
34	25	1 11/32	6	13812	
35	25	1 3/8	6	13813	
36	25	1 13/32	6	60646	
37	25	1 7/16	6	60647	
38	25	1 1/2	6	13816	
39	25	1 17/32	6	60648	
40	25	1 9/16	6	13818	
41	25	1 5/8	6	60649	
42	25	1 21/32	6	13820	
43	25	1 11/16	6	60652	
44	25	1 3/4	6	60650	
45	25	1 25/32	6	13823	
50	25		6	13828	
52	25	2 1/16	6	13830	
53	25	2 3/32	6	13831	
55	25		6	13833	
60	25	2 3/8	6	13838	
63	25		6	13841	
65	25	2 9/16	6	60651	
70	25	2 3/4	6	60653	
75	25		6	60654	
80	25		6	60655	
85	25		6	60656	
90	25		6	60657	
95	25	3 3/4	6	60658	
100	25	3 15/16	6	60659	

D mm	l mm	Pulgadas Inches Pouces	D* mm Broca Drill Bit Foret	Nº Art.	€
14	5	9/16	6	60660	
16	5	5/8	6	60661	
18	5	23/32	6	60662	
20	5	25/32	6	60663	
22	5	7/8	6	60664	
25	5	1	6	60666	
30	5	1 3/16	6	60667	
32	5	1 1/4	6	60668	
35	5	1 3/8	6	60669	
40	5	1 9/16	6	60670	
45	5	1 25/32	6	60671	
50	5		6	60672	
60	5	2 3/8	6	60673	

* Broca y muelle incluidos
Drill Bit & Spring included
Foret et ressort inclus

Display
66

CORONAS INOX
TCT STAINLESS Hole Saws
Trépan INOX



19 cm

∅	16	18	20	22	24	25	27	32
Pcs	1	1	1	1	1	1	1	1

Ref. 4995 - Nº Art. 71094: €

* Broca y muelle incluidos
Drill Bit & Spring included
Foret et ressort inclus



Ref. 1664



Broca / Drill Bit / Foret

D mm	L mm	Cap.	N° Art.	€ 1 ud.
5	48	12-15	83478	
6	48	16-100	60704	



Muelle / Spring / Ressort

D mm	L mm		N° Art.	€ pack
8,5	20	10	60637	
8,5	35	10	60638	

Ref. 1636

PERFORADOR DE CHAPA

Screw Hole Punch
Perforateur de tôle



HSS



Aceros
<850 N/mm²
Steel / Aciers

INOX
Stainless Steel
Acier INOX

D mm	D mm Broca Drill Bit - Foret	N° Art.	€
32,50	12,00	13671	
35,00	12,00	13676	

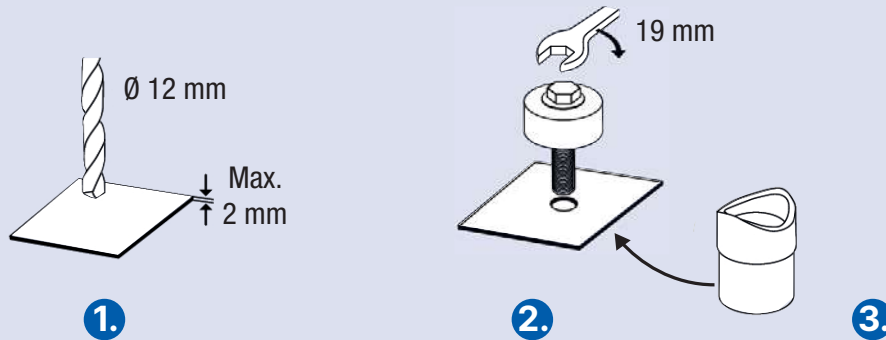

INSTRUCCIONES USO:

1. Taladrar un agujero previo con la broca
2. Introducir el tornillo por el agujero y por el lado contrario enroscar la cuchilla
3. Aplicar un par de apriete hasta seccionar la chapa

DIRECTIONS FOR USE:

1. Drill a pilot hole with the drill bit
2. Insert the screw through the hole and, on the opposite side, screw the blade
3. Apply a tightening torque until the sheet is divided

INSTRUCTIONS D'EMPLOI:

1. Percez un trou de guidage avec le foret
2. Insérez la vis dans le trou et, du côté opposé, vissez la lame
3. Appliquez un couple de serrage jusqu'à ce que la tôle soit divisée



ESCARIADORES

Reamers

Alésoids

Ref. **2010**

ESCARIADOR MANO

Hand Reamer
Alésoid à main

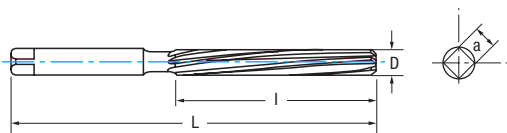

HSS	DIN 206 B	ISO 236	Tol. H7
-----	-----------	---------	---------

Aceros
<850 N/mm²
Steel / Aciers

Aluminio
Aluminium



	D mm	L mm	I mm	a mm	Nº Art.	€		D mm	L mm	I mm	a mm	Nº Art.	€		D mm	L mm	I mm	a mm	Nº Art.	€
(New!)	1,00	37	12		30685			5,80	93	47	4,30	74274			10,20	133	66	8,00	74370	
(New!)	1,50	41	20	1,12	30689			5,90	93	47	4,30	74277			10,30	133	66	8,00	74373	
	1,60	44	21	1,25	74178			6,00	93	47	4,30	40403			10,50	133	66	8,00	40430	
	1,70	44	21	1,25	74181			6,10	100	50	4,90	74280			10,60	142	71	8,00	74379	
	1,80	47	23	1,40	74184			6,20	100	50	4,90	75172			10,70	142	71	9,00	74382	
	1,90	50	25	1,60	74187			6,30	100	50	4,90	74283			10,80	142	71	9,00	74385	
	2,00	50	25	1,60	40379			6,40	100	50	4,90	74286			11,00	142	71	9,00	40433	
	2,10	50	25	1,60	74190			6,50	100	50	4,90	40406			11,10	142	71	9,00	74391	
	2,20	54	27	1,80	74193			6,60	100	50	4,90	75233			11,20	142	71	9,00	74394	
	2,40	58	29	2,10	74199			6,70	100	50	4,90	74289			11,30	142	71	9,00	74397	
	2,50	58	29	2,10	40382			6,80	107	54	5,50	74292			11,40	142	71	9,00	74400	
	2,60	58	29	2,10	75397			6,90	107	54	5,50	74295			11,50	142	71	9,00	40436	
	2,70	62	31	2,10	74202			7,00	107	54	5,50	40409			11,60	142	71	9,00	74403	
(New!)	2,90	62	31	2,10	74208			7,10	107	54	5,50	74298			11,70	142	71	9,00	74406	
	2,80	62	31	2,10	74205			7,20	107	54	5,50	74301			11,80	152	76	9,00	74409	
	3,00	62	31	2,10	40385			7,30	107	54	5,50	74947			11,90	152	76	10,00	74412	
	3,10	66	33	2,40	74211		(New!)	7,40	107	54	5,50	74304			12,00	152	76	10,00	40439	
	3,20	66	33	2,40	74214			7,50	107	54	5,50	40412			12,50	152	76	10,00	40442	
	3,30	66	33	2,40	74217			7,60	115	58	6,20	74307			13,00	152	76	10,00	40445	
	3,40	71	35	2,70	74220			7,80	115	58	6,20	74313			13,50	163	81	11,00	40448	
	3,50	71	35	2,70	40388			7,90	115	58	6,20	74316			14,00	163	81	11,00	40451	
	3,60	71	35	2,70	74223			8,00	115	58	6,20	40415			14,50	163	81	11,00	40454	
	3,70	71	35	2,70	74226			8,10	115	58	6,20	74319			15,00	163	81	11,00	40457	
	3,80	76	38	3,00	75398			8,20	115	58	6,20	74322			15,50	175	87	12,00	40460	
	3,90	76	38	3,00	74229			8,30	115	58	6,20	74325			16,00	175	87	12,00	40463	
	4,00	76	38	3,00	40391			8,50	115	58	6,20	40418			16,50	175	87	12,00	40466	
	4,10	76	38	3,00	74232			8,60	124	62	7,00	74331			17,00	175	87	12,00	40469	
	4,20	76	38	3,00	74235			8,80	124	62	7,00	74337			17,50	188	93	14,50	40472	
	4,30	81	41	3,40	74238			8,90	124	62	7,00	74340			18,00	188	93	14,50	40475	
	4,40	81	41	3,40	74241			9,00	124	62	7,00	40421			18,50	188	93	14,50	40478	
	4,50	81	41	3,40	40394			9,10	124	62	7,00	74343			19,00	188	93	14,50	40481	
	4,70	81	41	3,40	74247			9,20	124	62	7,00	74346			20,00	201	100	16,00	40487	
	4,80	87	44	3,80	74250			9,30	124	62	7,00	74349			21,00	201	100	16,00	40493	
	4,90	87	44	3,80	74253			9,40	124	62	7,00	74352			22,00	215	107	18,00	40499	
	5,00	87	44	3,80	40397			9,50	124	62	7,00	40424			23,00	215	107	18,00	40505	
	5,10	87	44	3,80	74256			9,60	133	66	8,00	74355			24,00	231	115	20,00	40511	
	5,20	87	44	3,80	74259			9,70	133	66	8,00	74358			25,00	231	115	20,00	40517	
	5,30	87	44	3,80	74262			9,80	133	66	8,00	74361			26,00	231	115	20,00	40523	
	5,40	93	47	4,30	74265			9,90	133	66	8,00	74364			27,00	247	124	22,40	40529	
	5,50	93	47	4,30	40400			10,00	133	66	8,00	40427			28,00	247	124	22,40	40535	
	5,60	93	47	4,30	74268			10,10	133	66	8,00	74367			30,00	247	124	22,40	40547	
	5,70	93	47	4,30	74271															



AVELLANADORES

Countersinks / Counterbores

Outils

Ref. **2575**

AVELLANADOR MANGO CILÍNDRICO 90°
90° Straight Shank Countersink
Fraise à noyer 90°

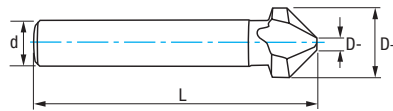

HSSE 5% Co	DIN 335 C	α 90°	3 Z	Tol. D (±0,05)	Tol. d (h9)	Tol. L (± 1)	Tol. α -1
----------------------	--------------	--------------	-----	-------------------	----------------	-----------------	---------------------

Aceros <850 N/mm ² Steel / Aciers	INOX Stainless Steel Acier INOX	Cobre Copper Cuivre	Aluminio Aluminium	Termoplásticos Thermoplastics Thermoplastiques
---	--	----------------------------------	------------------------------	---

D+ mm	D- mm	d mm	L mm	Nº Art.	€
4,30	1,30	4,00	40	74653	
5,00	1,50	4,00	40	74654	
5,30	1,50	4,00	40	74655	
5,80	1,50	5,00	45	74656	
6,00	1,50	5,00	45	74657	
6,30	1,50	5,00	45	74658	
7,00	1,80	6,00	50	74659	
7,30	1,80	6,00	50	74660	
8,00	2,00	6,00	50	74661	
8,30	2,00	6,00	50	74662	
9,40	2,20	6,00	50	74663	
10,00	2,50	6,00	50	74664	
10,40	2,50	6,00	50	74665	
11,50	2,80	8,00	56	74666	
12,40	2,80	8,00	56	74667	
13,40	2,90	8,00	56	74668	
15,00	3,20	10,00	60	74669	
16,50	3,20	10,00	60	74670	
19,00	3,50	10,00	63	74671	
20,50	3,50	10,00	63	74672	
23,00	3,80	10,00	67	74673	
25,00	3,80	10,00	67	74674	
28,00	4,00	12,00	71	42714	
30,00	4,20	12,00	71	12588	
31,00	4,20	12,00	71	42715	
40,00	5,00	15,00	80	11061	



Set 6 Pcs

Cont. Ø	Nº Art.	€
6,3-8,3-10,4-12,4-16,5-20,5	40515	

Recubrimiento bajo demanda / Coating upon request / Revêtement sur demande

Línea 33 cm - Ref. 2575



Ø	5	6	7	10	12,4	15
Pcs	2	2	2	2	2	2

Ref. 4995 - Nº Art. 70987: €



Ref. **2530**

AVELLANADOR MANGO CILÍNDRICO ALLEN

Allen Straight Shank Counterbore
Fraise à lamer et chambrer

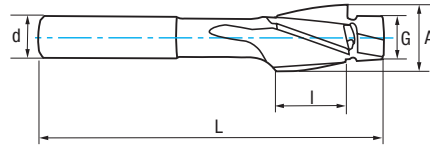

HSS	DIN 373	ISO 4206	Allen		Tol. A z9	Tol. G e8	Tol. d h9	Aluminio Aluminium >10% Si
------------	---------	----------	-------	--	-----------	-----------	-----------	--

Aceros <850 N/mm² Steel / Aciers	Aceros <1000 N/mm² Steel / Aciers	INOX Ferríticos-Martensíticos Ferritic-Martensitic Stainless INOX Ferritiques-Martensitiques	Fundición Cast Iron Fonte	Titanio Titanium Titane	Cobre Copper Cuivre
---	--	---	--	--	------------------------------------

M	A mm	G mm	d mm	L mm	l mm	Z	Nº Art.	€
M3	6,50	3,40	5,00	71	14	3	42029	
M4	8,00	4,50	5,00	71	14	3	42032	
M5	10,00	5,50	8,00	80	18	3	42035	
M6	11,00	6,60	8,00	80	18	3	42038	
M8	15,00	9,00	12,50	100	22	3	42041	
M10	18,00	11,00	12,50	100	22	3	42044	
M12	20,00	13,50	12,50	100	22	3	42047	
M14	24,00	15,50	16,00	100	22	4	42050	
M16	26,00	17,50	16,00	100	22	4	42053	



Set 6 Pcs

Cont.	Nº Art.	€
M3-M4-M5- M6-M8-M10	40512	

Línea 33 cm - Ref. 2530



∅	M5	M6	M8	M10	M12
Pcs	1	1	1	1	1

Ref. 4995 - Nº Art. 72112: €



Ref. 2572

AVELLANADOR MANGO CILÍNDRICO 90°

90° Straight Shank Countersink
Fraise à ebavurer 90°

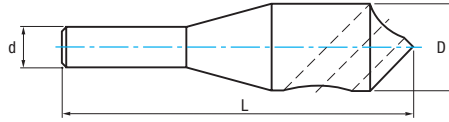

HSSE 5% Co	IZAR Std.	α 90°	Tol. D +0 +0,3	Tol. d (h9)	Tol. L (\pm 1)	Tol. α 0 -1
----------------------	--------------	--------------	----------------------	----------------	----------------------	--------------------------

Aceros <850 N/mm ² Steel / Aciers	INOX Ferríticos-Martensíticos Ferritic-Martensitic Stainless INOX Ferritiques-Martensitiques	Aluminio Aluminium
---	---	------------------------------

Aplic. mm	D mm	d mm	L mm	N° Art.	€
2-5	10,00	6,00	46	69183	
5-10	14,00	8,00	55	69181	
10-15	20,00	10,00	65	69184	
15-20	28,00	12,00	85	69187	
20-25	30,00	15,00	95	69186	



Set 4 Pcs

Aplic. mm	N° Art.	€
2-5, 5-10, 10-15, 15-20	40513	

Línea 33 cm - Ref. 2572



∅	2-5	5-10	10-15	15-20	20-25
Pcs	1	1	1	1	1

Ref. 4995 - N° Art. 72115: €



MACHOS Y COJINETES

Taps & Dies

Tarauts et Filières

Ref. **3030**

JUEGO MACHOS MANO MÉTRICA

Metric Hand Tap Set

Jeu de tarauds à main métrique

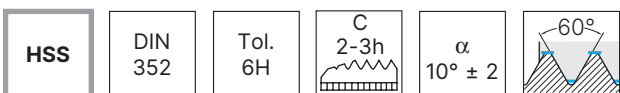
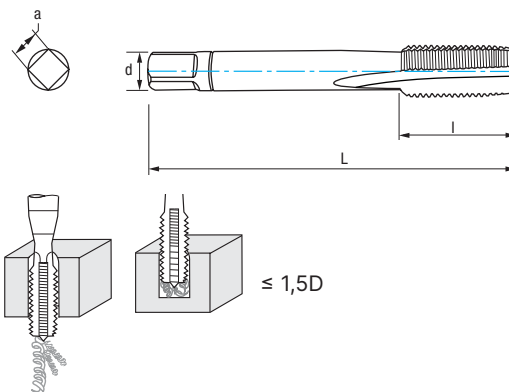

M	P	L mm	l mm	d mm	a mm	Z	Nº Art.	€
M2	0,40	36	8	2,80	2,10	3	62531	
M2,5	0,45	40	9	2,80	2,10	3	62534	
M3	0,50	40	11	3,50	2,70	3	62537	
M3,5	0,60	45	13	4,00	3,00	3	62540	
M4	0,70	45	13	4,50	3,40	3	62543	
M4	0,75	45	14	4,50	3,40	3	76377	
M4,5	0,75	50	16	6,00	4,90	3	62546	
M5	0,80	50	16	6,00	4,90	3	62549	
M6	1,00	56	19	6,00	4,90	3	62552	
M7	1,00	56	19	6,00	4,90	3	62555	
M8	1,25	56	22	6,00	4,90	4	62561	
M9	1,25	63	22	7,00	5,50	4	62567	
M10	1,50	70	24	7,00	5,50	4	62573	
M11	1,50	70	24	8,00	6,20	4	62576	
M12	1,75	75	28	9,00	7,00	4	62579	
M13	1,75	75	28	9,00	7,00	4	62582	
M14	2,00	80	30	11,00	9,00	4	62585	

M	P	L mm	l mm	d mm	a mm	Z	Nº Art.	€
M15	2,00	80	32	12,00	9,00	4	62588	
M16	2,00	80	32	12,00	9,00	4	62591	
M18	2,50	95	34	14,00	11,00	4	62594	
M20	2,50	95	34	16,00	12,00	4	62597	
M22	2,50	100	34	18,00	14,50	4	62603	
M24	3,00	110	50	18,00	14,50	4	62606	
M27	3,00	110	50	20,00	16,00	4	62609	
M30	3,50	125	50	22,00	18,00	4	62612	
M33	3,50	125	50	25,00	20,00	4	62615	
M36	4,00	150	56	28,00	22,00	4	62618	
M39	4,00	150	60	32,00	24,00	4	62621	
M42	4,50	150	60	32,00	24,00	4	62624	
M45	4,50	160	65	36,00	29,00	6	73760	
M48	5,00	180	70	36,00	29,00	6	62627	
M52	5,00	180	70	40,00	32,00	6	76382	
M56	5,50	180	70	40,00	32,00	6	76383	
M60	5,50	200	85	45,00	35,00	6	76384	

Macho único Ref. 3010 disponible en [pag. 140](#)

Single Tap Ref. 3010 available in [page 140](#)

Taraut unique Ref. 3010 disponible [pag. 140](#)



Ref. **3003**

JUEGO MACHOS MANO MÉTRICA

Metric Hand Tap Set
Jeu de tarauds à main métrique

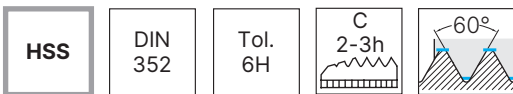
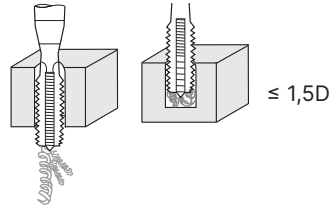
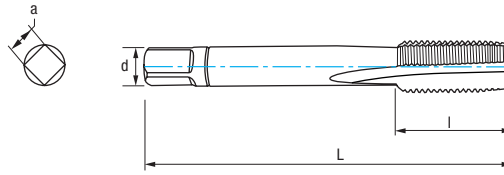

M	P	L mm	l mm	d mm	a mm	Z	Nº Art.	€
M3	0,50	40	11	3,50	2,70	3	42876	
M4	0,70	45	13	4,50	3,40	3	42879	
M5	0,80	50	16	6,00	4,90	3	42882	
M6	1,00	56	19	6,00	4,90	3	42884	
M7	1,00	56	19	6,00	4,90	3	42885	
M8	1,25	63	22	6,00	4,90	4	42886	
M10	1,50	70	24	7,00	5,50	4	42887	
M12	1,75	75	28	9,00	7,00	3	42888	
M14	2,00	80	30	11,00	9,00	4	42889	
M16	2,00	80	32	12,00	9,00	4	42890	
M18	2,50	95	34	14,00	11,00	4	42891	
M20	2,50	95	34	16,00	12,00	4	42892	



Macho único Ref. 3001 disponible en [pag. 143](#)

Single Tap Ref. 3001 available in [page 143](#)

Taraud unique Ref. 3001 disponible [pag. 143](#)

Línea 33 cm - Ref. 3003



∅	M3	M5	M6	M10	M12
Pcs	3	3	3	3	3

Ref. 4995 - Nº Art. 70990: €



Display 22 - Ref. 3003



∅	M20	Mod. 01	Mod. 02	Mod. 10	Mod. 20		
Pcs	1	1	1	1	1		
∅	M12	M14	M16	M18			
Pcs	2	1	1	1			
∅	M-3	M-4	M-5	M-6	M-7	M-8	M10
Pcs	2	2	2	2	2	2	2

Ref. 4995 - N° Art. 22298: €

Display 44 - Ref. 3003



∅	M-4	M-5	M-6	M-8	M-10	O1
Pcs	2	2	2	2	2	2

Ref. 4995 - N° Art. 42490: €

Ref. **3036**

JUEGO MACHOS MANO MÉTRICA/ MÉTRICA FINA COBALTO INOX

STAINLESS Cobalt Metric / Metric Fine Hand Tap Set

Jeu de tarauds à main métrique / métrique pas fin Cobalt INOX

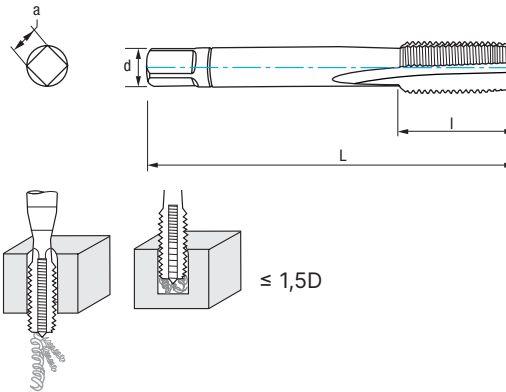

HSSE 5% Co	M DIN 352	MF DIN 2181	Tol. 6H	Vaporiz.	C 2-3h	α 6-8°	60°	Vaporizado Vaporized Vaporisée
Grupo Group-Gruppe P	Subgrup. P.5	INOX Stainless Steel Acier INOX	Fundición Cast Iron Fonte	Nº1 Desbaste Roughing Ébauche	Nº2 Semidesbaste Semiroughing Semi-ébauche	Nº3 Acabado Finishing Finition	Nº1-Nº2 Con guía Guided Avec guide	

M	P	L mm	l mm	d mm	a mm	Z	Nº Art.	€
M2	0,40	36	8	2,80	2,10	3	69229	
M3	0,50	40	11	3,50	2,70	3	16404	
M4	0,70	45	13	4,50	3,40	3	16405	
M5	0,80	50	16	6,00	4,90	3	16406	
MF6	0,75	56	14	6,00	4,90	3	82254	
M6	1,00	56	19	6,00	4,90	3	16407	
MF8	1,00	63	18	6,00	4,90	3	82255	
M8	1,25	63	22	6,00	4,90	3	16408	
MF10	1,00	63	18	7,00	5,50	3	82256	
M10	1,50	70	24	7,00	5,50	3	16409	
MF12	1,00	70	18	9,00	7,00	3	82257	
MF12	1,50	70	22	9,00	7,00	3	82258	
M12	1,75	75	29	9,00	7,00	3	16410	
MF14	1,50	70	22	11,00	9,00	4	82259	
M14	2,00	80	30	11,00	9,00	4	16411	
MF16	1,50	70	22	12,00	9,00	4	82290	
M16	2,00	80	32	12,00	9,00	4	16412	
MF18	1,50	80	22	14,00	11,00	4	82260	
M18	2,50	95	40	14,00	11,00	4	16413	
MF20	1,50	80	22	16,00	12,00	4	82261	
M20	2,50	95	40	16,00	12,00	4	16414	



Ref. **3037**

MACHO ÚNICO MÉTRICA/ MÉTRICA FINA COBALTO INOX

STAINLESS Cobalt Metric / Metric Fine Hand **Single** Tap

Taroud à main **unique** métrique / métrique pas fin Cobalt INOX

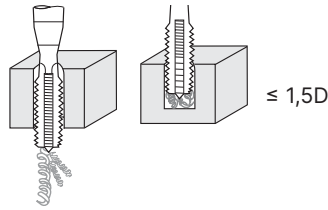
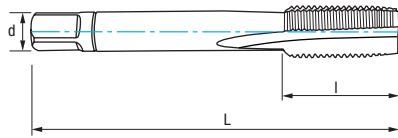

HSSE 5% Co	M DIN 352	MF DIN 2181	Tol. 6H	Vaporiz.	C 2-3h	α 6-8°	60°
----------------------	-----------------	-------------------	------------	----------	-----------	------------------	-----

Grupo Group-Grp P	Subgrup. P.5	INOX Stainless Steel Acier INOX	Fundición Cast Iron Fonte	N°1 Desbaste Roughing Ébauche	N°2 Semidesbaste Semiroughing Semi-ébauche	N°3 Acabado Finishing Finition	N°1-N°2 Con guía Guided Avec guide
--------------------------------	------------------------	--	--	--	---	---	---

M	P	L mm	I mm	d mm	a mm	Z	N° 3	N° 1	N° 2	€
							Acabado Finishing Finition	Desbaste Roughing Ébauche	Semidesbaste Semiroughing Semi-Ébauche	
M2	0,40	36	8	2,80	2,10	3	83127	83125	83126	
M3	0,50	40	11	3,50	2,70	3	74981	74979	74980	
M4	0,70	45	13	4,50	3,40	3	75010	74982	74983	
M5	0,80	50	16	6,00	4,90	3	74986	74984	74985	
MF6	0,75	56	14	6,00	4,90	3	82264	82262		
M6	1,00	56	19	6,00	4,90	3	74990	74988	74989	
MF8	1,00	63	18	6,00	4,90	3	82267	82265		
M8	1,25	63	22	6,00	4,90	3	74993	74991	74992	
MF10	1,00	63	18	7,00	5,50	3	82270	82268		
M10	1,50	70	24	7,00	5,50	3	74998	74994	74997	
MF12	1,00	70	18	9,00	7,00	3	82273	82271		
MF12	1,50	70	22	9,00	7,00	3	82276	82274		
M12	1,75	75	29	9,00	7,00	3	75003	74999	75000	
MF14	1,50	70	22	11,00	9,00	4	82279	82277		
M14	2,00	80	30	11,00	9,00	4	75006	75004	75005	
MF16	1,50	70	22	12,00	9,00	4	82283	82280		
M16	2,00	80	32	12,00	9,00	4	74974	72865	72864	
MF18	1,50	80	22	14,00	11,00	4	82286	82284		
M18	2,50	95	40	14,00	11,00	4	75009	75007	75008	
MF20	1,50	80	22	16,00	12,00	4	82289	82287		
M20	2,50	95	40	16,00	12,00	4	59960	74131	74977	



Ref. **3020**

JUEGO MACHOS MANO MÉTRICA FINA

Metric Fine Hand Tap Set

Jeu de tarauds à main métrique pas fin

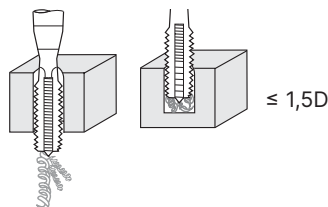
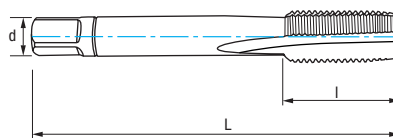

HSS

DIN 2181

Tol. 6H

C 2-3h

α $10^\circ \pm 2$

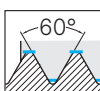

Nº1 Desbaste
Roughing
Ébauche

Nº3 Acabado
Finishing
Finition

Aceros
<math><850 \text{ N/mm}^2</math>
Steel / Aciers

Fundición
Cast Iron
Fonte

Cobre
Copper
Cuivre

Aluminio
Aluminium



MF	P	L mm	l mm	d mm	a mm	Z	Nº Art.	€
MF4	0,50	45	10	4,50	3,40	3	62336	
MF5	0,50	50	12	6,00	4,90	3	62342	
MF5	0,75	50	12	6,00	4,90	3	62345	
MF6	0,50	50	14	6,00	4,90	3	62351	
MF6	0,75	50	14	6,00	4,90	3	62354	
MF7	0,75	50	14	6,00	4,90	3	62360	
MF8	0,50	50	19	6,00	4,90	4	62366	
MF8	0,75	50	19	6,00	4,90	4	62369	
MF8	1,00	56	20	6,00	4,90	4	62372	
MF9	1,00	63	20	7,00	5,50	4	75090	
MF10	0,50	63	20	7,00	5,50	4	21727	
MF10	0,75	63	20	7,00	5,50	4	76309	
MF10	1,00	63	20	7,00	5,50	4	62378	
MF10	1,25	70	24	7,00	5,50	4	62381	
MF11	0,75	63	20	8,00	6,20	4	16118	
MF11	1,00	63	20	8,00	6,20	4	76311	
MF11	1,25	63	20	8,00	6,20	4	75298	
MF12	0,75	70	22	9,00	7,00	4	76312	
MF12	1,00	70	20	9,00	7,00	4	62387	
MF12	1,25	70	22	9,00	7,00	4	62390	
MF12	1,50	70	22	9,00	7,00	4	62393	
MF13	0,75	70	22	11,00	9,00	4	56832	
MF13	1,00	70	20	11,00	9,00	4	76314	
MF13	1,25	70	22	11,00	9,00	4	76315	
MF13	1,50	70	22	11,00	9,00	4	62399	
MF14	0,75	70	22	11,00	9,00	4	56833	
MF14	1,00	70	20	11,00	9,00	4	62402	
MF14	1,25	70	20	11,00	9,00	4	62405	
MF14	1,50	70	20	11,00	9,00	4	62408	
MF14	1,75	70	30	11,00	9,00	4	10875	
MF15	1,00	70	20	12,00	9,00	4	76318	
MF15	1,25	70	22	12,00	9,00	4	76319	
MF15	1,50	70	20	12,00	9,00	4	75299	
MF16	1,00	70	20	12,00	9,00	4	62414	
MF16	1,25	70	20	12,00	9,00	4	76320	
MF16	1,50	70	20	12,00	9,00	4	62417	

MF	P	L mm	l mm	d mm	a mm	Z	Nº Art.	€
MF17	1,00	70	22	12,00	9,00	4	76321	
MF17	1,25	70	22	12,00	9,00	4	56834	
MF17	1,50	70	22	12,00	9,00	4	62420	
MF18	1,00	80	22	14,00	11,00	4	62423	
MF18	1,25	80	22	14,00	11,00	4	76323	
MF18	1,50	80	22	14,00	11,00	4	62426	
MF18	2,00	80	22	14,00	11,00	4	62429	
MF19	1,00	80	22	14,00	11,00	4	10831	
MF19	1,25	80	22	14,00	11,00	4	56835	
MF19	1,50	80	22	14,00	11,00	4	76326	
MF19	2,00	80	22	14,00	11,00	4	56837	
MF20	1,00	80	22	16,00	12,00	4	76327	
MF20	1,25	80	22	16,00	12,00	4	74816	
MF20	1,50	80	22	16,00	12,00	4	62435	
MF20	2,00	80	22	16,00	12,00	4	62438	
MF21	1,00	80	22	16,00	12,00	4	56838	
MF21	1,25	80	22	16,00	12,00	4	56840	
MF21	1,50	80	22	16,00	12,00	4	75300	
MF22	1,00	80	22	18,00	14,50	4	76330	
MF22	1,25	80	22	18,00	14,50	4	74601	
MF22	1,50	80	22	18,00	14,50	4	62441	
MF22	2,00	80	22	18,00	14,50	4	62444	
MF23	1,00	80	22	18,00	14,50	4	56841	
MF23	1,50	80	22	18,00	14,50	4	56842	
MF24	1,00	90	22	18,00	14,50	4	76333	
MF24	1,25	90	22	18,00	14,50	4	62447	
MF24	1,50	90	22	18,00	14,50	4	62450	
MF24	2,00	90	22	18,00	14,50	4	62453	
MF25	1,00	90	22	18,00	14,50	4	76334	
MF25	1,25	90	22	18,00	14,50	4	56843	
MF25	1,50	90	22	18,00	14,50	4	75301	
MF25	2,00	90	22	18,00	14,50	4	56844	
MF26	1,00	90	22	18,00	14,50	4	56846	
MF26	1,50	90	22	18,00	14,50	4	75302	
MF26	2,00	90	22	18,00	14,50	4	56847	
MF27	1,00	90	22	20,00	16,00	4	76338	

Cont.



Cont.

MF	P	L mm	l mm	d mm	a mm	Z	Nº Art.	€
MF27	1,50	90	22	20,00	16,00	4	76339	
MF27	2,00	90	22	20,00	16,00	4	75303	
MF28	1,00	90	22	20,00	16,00	4	76340	
MF28	1,50	90	22	20,00	16,00	4	76341	
MF30	1,00	90	22	22,00	18,00	4	76342	
MF30	1,50	90	22	22,00	18,00	4	76343	
MF30	2,00	90	22	22,00	18,00	4	75304	
New! MF30	3,00	90	22	22,00	18,00	4	14421	
MF32	1,50	90	22	22,00	18,00	4	76345	
MF33	1,50	100	25	25,00	20,00	4	76348	
MF33	2,00	100	25	25,00	20,00	4	75305	
MF34	1,50	100	25	28,00	22,00	4	76349	
MF35	1,50	100	25	28,00	22,00	4	76350	
MF36	1,50	100	25	28,00	22,00	4	76351	
MF36	2,00	125	33	28,00	22,00	4	76140	
MF36	3,00	125	33	28,00	22,00	4	76352	
MF38	1,50	100	25	28,00	22,00	4	76353	
MF38	2,00	125	40	28,00	22,00	4	75306	
MF39	1,50	110	25	32,00	24,00	4	76354	
MF39	2,00	125	33	32,00	24,00	4	76355	
MF39	3,00	125	33	32,00	24,00	4	76356	
MF40	1,50	110	25	32,00	24,00	6	76357	
MF40	2,00	110	25	32,00	24,00	6	76358	
MF40	3,00	125	40	32,00	24,00	6	76359	
MF42	2,00	125	33	32,00	24,00	6	76361	
MF42	3,00	125	33	32,00	24,00	6	76362	
MF45	1,50	110	25	36,00	29,00	6	76363	
MF45	2,00	125	33	36,00	29,00	6	76364	
MF45	3,00	125	33	36,00	29,00	6	76365	
MF48	1,50	140	33	36,00	29,00	6	76366	
MF48	2,00	140	33	36,00	29,00	6	76367	
MF48	3,00	140	33	36,00	29,00	6	76368	
MF50	1,50	140	40	36,00	29,00	6	76369	
MF52	1,50	140	40	40,00	32,00	6	76370	
MF52	2,00	140	40	40,00	32,00	6	77643	
MF52	3,00	140	40	40,00	32,00	6	76372	



Ref. **3010**

MACHO ÚNICO MANO MÉTRICA/ MÉTRICA FINA

Metric / Metric Fine Hand **Single Tap**

Taroud à main **unique** métrique / métrique pas fin

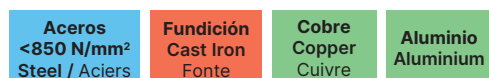
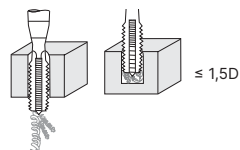
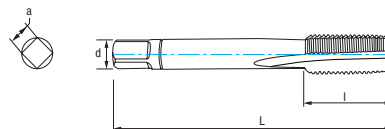

M/MF	P	L mm	l mm	d mm	a mm	Z	N°3 Acabado Finishing Finition (M Ref. 3030 / MF Ref. 3020)		N° 1 Desbaste M Roughing Ébauche (Ref. 3030)		N° 2 Semidesbaste M Semiroughing Semi-ébauche (Ref. 3030)	
							N° Art.	€	N° Art.	€	N° Art.	€
M2	0,40	36	8	2,80	2,10	3	76385		22710		33368	
M2	0,45	41	8	2,50	2,00	3	16451					
M2,5	0,45	40	9	2,80	2,10	3	76387					
M3	0,50	40	11	3,50	2,70	3	76389		11158		12723	
M3,5	0,60	45	13	4,00	3,00	3	76391		66186		20538	
MF4	0,50	45	10	4,50	3,40	3	76393					
M4	0,70	45	13	4,50	3,40	3	76394		18943		11263	
M4,5	0,75	50	16	6,00	4,90	3	76397		66187		66192	
MF5	0,50	50	12	6,00	4,90	3	59484					
MF5	0,75	50	12	6,00	4,90	3	59485					
M5	0,80	50	16	6,00	4,90	3	76400		11262		26620	
MF6	0,50	50	14	6,00	4,90	3	59486					
MF6	0,75	50	14	6,00	4,90	3	76405					
M6	1,00	50	19	6,00	4,90	3	75383		10630		10833	
MF7	0,75	50	14	6,00	4,90	3	46217					
M7	1,00	50	19	6,00	4,90	3	76408		66201		32812	
MF8	0,50	50	19	6,00	4,90	4	59487					
MF8	0,75	50	19	6,00	4,90	4	59488					
MF8	1,00	56	20	6,00	4,90	4	76411					
M8	1,25	56	22	6,00	4,90	4	75449		10938		26629	
MF9	1,00	63	20	7,00	5,50	4	34577					
M9	1,25	63	22	7,00	5,50	4	76414		66208		20543	
MF10	0,50	63	20	7,00	5,50	4	59489					
MF10	0,75	63	20	7,00	5,50	4	59490					
MF10	1,00	63	20	7,00	5,50	4	76417					
MF10	1,25	70	24	7,00	5,50	4	76418					
M10	1,50	70	24	7,00	5,50	4	74995		11148		15086	
MF11	0,75	63	20	8,00	6,20	4	59491					
MF11	1,00	63	20	8,00	6,20	4	59492					
MF11	1,25	63	22	8,00	6,20	4	59493					
M11	1,50	70	24	8,00	6,20	4	76422		25211		21282	
MF12	0,75	70	22	9,00	7,00	4	59494					
MF12	1,00	70	20	9,00	7,00	4	22221					
MF12	1,25	70	22	9,00	7,00	4	76425					
MF12	1,50	70	22	9,00	7,00	4	76426					
M12	1,75	75	29	9,00	7,00	4	74996		10834		28407	

MF N°1 bajo demanda upon request sur demande

Cont.





Ref. **3010**

MACHO ÚNICO MANO MÉTRICA/ MÉTRICA FINA

Metric / Metric Fine Hand **Single Tap**

Taraud à main **unique** métrique / métrique pas fin



Cont.

M/MF	P	L mm	I mm	d mm	 a mm	 Z	Nº3 Acabado Finishing Finition (M Ref. 3030 / MF Ref. 3020)		Nº 1 Desbaste M Roughing Ébauche (Ref. 3030)		Nº 2 Semidesbaste M Semiroughing Semi-ébauche (Ref. 3030)	
							Nº Art.	€	Nº Art.	€	Nº Art.	€
MF13	0,75	70	22	11,00	9,00	4	59495					
MF13	1,00	70	20	11,00	9,00	4	59496					
MF13	1,25	70	22	11,00	9,00	4	59497					
MF13	1,50	70	22	11,00	9,00	4	59498					
MF14	0,75	70	22	11,00	9,00	4	59499					
MF14	1,00	70	20	11,00	9,00	4	76433					
MF14	1,25	70	20	11,00	9,00	4	45040					
MF14	1,50	70	20	11,00	9,00	4	76435					
MF14	1,75	70	30	11,00	9,00	4	59500					
M14	2,00	80	30	11,00	9,00	4	76436		11772		20529	
MF15	1,00	70	20	12,00	9,00	4	59501					
MF15	1,25	70	22	12,00	9,00	4	59503					
MF15	1,50	70	20	12,00	9,00	4	76439					
MF16	1,00	70	22	12,00	9,00	4	59504					
MF16	1,25	70	22	12,00	9,00	4	59505					
MF16	1,50	70	20	12,00	9,00	4	76443					
M16	2,00	80	32	12,00	9,00	4	76444		17461		16312	
MF17	1,00	70	22	12,00	9,00	4	59506					
MF17	1,25	70	22	12,00	9,00	4	59507					
MF17	1,50	70	22	12,00	9,00	4	59562					
MF18	1,00	80	22	14,00	11,00	4	59508					
MF18	1,25	80	22	14,00	11,00	4	59509					
MF18	1,50	80	22	14,00	11,00	4	45039					
MF18	2,00	80	22	14,00	11,00	4	59510					
M18	2,50	95	40	14,00	11,00	4	76452		11916		66249	
MF19	1,25	80	22	14,00	11,00	4	59511					
MF19	1,50	80	22	14,00	11,00	4	59512					
MF19	2,00	80	22	14,00	11,00	4	59513					
MF20	1,00	80	22	16,00	12,00	4	59514					
MF20	1,25	80	22	16,00	12,00	4	59515					
MF20	1,50	80	22	16,00	12,00	4	76476					
MF20	2,00	80	22	16,00	12,00	4	59516					
M20	2,50	95	40	16,00	12,00	4	76478		11917		17261	
MF21	1,00	80	22	16,00	12,00	4	59517					
MF21	1,25	80	22	16,00	12,00	4	59518					
MF21	1,50	80	22	16,00	12,00	4	59519					
MF22	1,00	80	22	18,00	14,50	4	59521					
MF22	1,25	80	22	18,00	14,50	4	59522					
MF22	1,50	80	22	18,00	14,50	4	76484					
MF22	2,00	80	22	18,00	14,50	4	76485					
M22	2,50	100	40	18,00	14,50	4	76486		65789		15241	
MF23	1,00	80	22	18,00	14,50	4	59523					
MF23	1,50	80	22	18,00	14,50	4	59524					
MF24	1,25	90	22	18,00	14,50	4	59525					
MF24	2,00	90	22	18,00	14,50	4	59526					
M24	3,00	110	50	18,00	14,50	4	76493		58475		12505	
MF25	1,00	90	22	18,00	14,50	4	59527					
MF25	1,25	90	22	18,00	14,50	4	59528					
MF25	2,00	90	22	18,00	14,50	4	59561					
MF26	1,00	90	22	18,00	14,50	4	59529					
MF26	1,50	90	22	18,00	14,50	4	59530					
MF26	2,00	90	22	18,00	14,50	4	59531					
MF27	1,00	90	22	20,00	16,00	4	59532					
MF27	1,50	90	22	20,00	16,00	4	59533					
M27	3,00	110	50	20,00	16,00	4	76505		10836		66294	
MF28	1,00	90	22	20,00	16,00	4	59534					

Cont.



Cont.

M/MF	P	L mm	I mm	d mm	 a mm	 Z	Nº3 Acabado Finishing Finition (M Ref. 3030 / MF Ref. 3020)		Nº1 Desbaste M Roughing Ébauche (Ref. 3030)		Nº2 Semidesbaste M Semiroughing Semi-ébauche (Ref. 3030)	
							Nº Art.	€	Nº Art.	€	Nº Art.	€
MF28	1,50	90	22	20,00	16,00	4	59535					
MF30	1,00	90	22	22,00	18,00	4	16388					
MF30	1,50	90	22	22,00	18,00	4	59536					
M30	3,50	125	50	22,00	18,00	4	76512		26582		13046	
New! MF32	1,50	90	22	22,00	18,00	4	25967					
MF33	1,50	100	25	25,00	20,00	4	59537					
MF33	2,00	100	25	25,00	20,00	4	59538					
M33	3,50	125	56	25,00	20,00	4	76519		66307		66308	
MF34	1,50	100	25	28,00	22,00	4	59539					
MF35	1,50	100	25	28,00	22,00	4	59540					
MF36	1,50	100	25	28,00	22,00	4	59541					
MF36	3,00	125	40	28,00	22,00	4	59542					
M36	4,00	150	63	28,00	22,00	4	76525		66317		38036	
MF38	1,50	100	25	28,00	22,00	4	59543					
MF38	2,00	125	40	28,00	22,00	4	59544					
MF39	1,50	110	25	32,00	24,00	4	59545					
MF39	2,00	125	40	32,00	24,00	4	59546					
MF39	3,00	125	40	28,00	22,00	4	59547					
M39	4,00	150	63	32,00	24,00	4	76531		66328		66329	
MF40	1,50	110	25	32,00	24,00	4	59548					
MF40	2,00	125	40	32,00	24,00	4	59549					
MF40	3,00	125	40	32,00	24,00	4	59550					
MF42	1,50	110	25	32,00	24,00	4	14781					
MF42	2,00	125	40	32,00	24,00	4	59551					
MF42	3,00	125	40	32,00	24,00	4	59552					
M42	4,50	150	63	32,00	24,00	4	76538		66342		61071	
MF45	1,50	110	25	36,00	29,00	6	16389					
MF45	2,00	125	40	36,00	29,00	6	59553					
MF45	3,00	125	40	36,00	29,00	6	59554					
M45	4,50	160	70	36,00	29,00	6	76542		32663		32664	
MF48	1,50	140	40	36,00	29,00	6	16390					
MF48	2,00	140	40	36,00	29,00	6	59555					
MF48	3,00	140	40	36,00	29,00	6	59556					
M48	5,00	180	75	36,00	29,00	6	76546		66355		66356	
MF50	1,50	140	40	36,00	29,00	6	59557					
MF52	1,50	140	40	40,00	32,00	6	59558					
MF52	2,00	140	40	40,00	32,00	6	59559					
MF52	3,00	140	40	40,00	32,00	6	59560					
M52	5,00	180	75	40,00	32,00	6	76551		66367		66368	



Ref. **3001**

MACHO ÚNICO MANO MÉTRICA

Metric Hand **Single** Tap
Taraud à main **unique** métrique

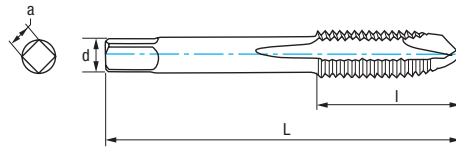

HSS	DIN 352	Tol. 6H	GUN	60°	N°3 Acabado Finishing Finition
------------	---------	---------	-----	-----	---

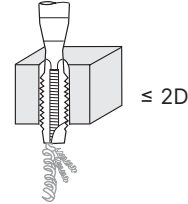

Aceros <math><850 \text{ N/mm}^2</math> Steel / Aciers	Fundición Cast Iron Fonte	Cobre Copper Cuivre	Aluminio Aluminium
---	--	----------------------------------	------------------------------

M	P	L mm	l mm	d mm	a mm	Z	Nº Art.	€
M3	0,50	40	11	3,50	2,70	3	25217	
M4	0,70	45	13	4,00	3,00	3	25218	
M5	0,80	50	16	6,00	4,90	3	25219	
M6	1,00	56	19	6,00	4,90	3	25220	
M8	1,25	56	22	6,00	4,90	4	25222	
M10	1,50	70	24	7,00	5,50	4	25224	
M12	1,75	75	29	9,00	7,00	3	25374	



Línea 33 cm - Ref. 3001



ø	M3	M5	M6	M8	M10
Pcs	3	3	3	3	3

Ref. 4995 - Nº Art. 72118: €



Ref. **3023**

MACHO MANO PERFIL ROSCA COMPLETA

Whole Thread Profile Hand Tap
Taraud à main profil filetage complet

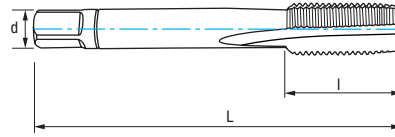

HSS	DIN 352	Tol. 6H	α $10^\circ \pm 2$	4-6h	60°
Aceros <850 N/mm² Steel / Aciers	Fundición Cast Iron Fonte	Cobre Copper Cuivre	Aluminio Aluminium		

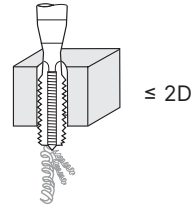

Macho único que **finaliza la rosca completa** en agujeros pasantes. Espesor material <1,5 mm. Viruta media/larga.

Single tap for **whole thread finishing** in through holes. Material thickness <1,5 mm. Medium/long chip removal.

Guidage et filetage complet sur trous débouchants. Épaisseur matériel <1,5 mm. Copeaux moyens/longs.

M	P	L mm	l mm	d mm	a mm	Z	N° Art.	€
M3	0,50	40	11	3,50	2,70	3	46263	
M4	0,70	45	13	4,50	3,40	3	46264	
M5	0,80	50	16	6,00	4,90	3	46265	
M6	1,00	50	19	6,00	4,90	3	46266	
M8	1,25	56	22	6,00	4,90	4	46267	
M10	1,50	70	24	7,00	5,50	4	46268	
M12	1,75	75	29	9,00	7,00	4	46269	
M16	2,00	80	32	12,00	9,00	4	46270	
M20	2,50	95	40	16,00	12,00	4	46271	



Línea 33 cm - Ref. 3023



∅	M3	M4	M5	M6	M8	M10
Pcs	5	5	5	5	5	5
Ref. 4995 - N° Art. 72121:						€



Ref. **3040**



JUEGO MACHOS ÚNICOS MANO MÉTRICA NORMA ISO

ISO Standard Metric Hand Single Tap Set

Jeu de tarauds **uniques** à main métrique **norme ISO**

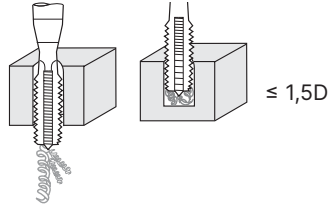
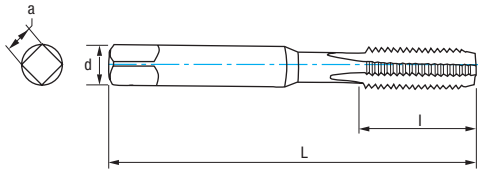
- Nº3  **C 2-3h**
- Nº3  **B 3,5-5h**
- Nº3  **A 6-8h**



HSS	ISO 529	Tol. 6H	A 6-8h	B 3,5-5h	C 2-3h		α $10^\circ \pm 2$		Nº3 Acabado Finishing Finition
------------	----------------	---------	--------	----------	--------	---	------------------------------	--	---

Aceros <math><850 \text{ N/mm}^2</math> Steel / Acciai	Fundición Cast Iron Ghisa	Cobre Copper Rame	Aluminio Aluminium Alluminio
---	--	--------------------------------	---

M	P	L mm	l mm	d mm	a mm	Z	Nº Art.	€
M2	0,40	41	8	2,50	2,00	3	83527	
M3	0,50	48	11	3,15	2,50	3	68870	
M4	0,70	53	13	4,00	3,15	3	68871	
M5	0,80	58	16	5,00	4,00	3	68872	
M6	1,00	66	19	6,30	5,00	3	68873	
M8	1,25	72	22	8,00	6,30	4	68874	
M10	1,50	80	24	10,00	8,00	4	68875	
M12	1,75	89	29	9,00	7,10	4	68876	
M14	2,00	95	30	11,20	9,00	4	68877	
M16	2,00	102	32	12,50	10,00	4	68878	



Ref. 3039

MACHO ÚNICO MANO MÉTRICA / MÉTRICA FINA NORMA ISO

ISO Standard Metric / Metric Fine Hand Single Tap

Taroud à main **únique** métrique / métrique pas fin **norme ISO**

New!

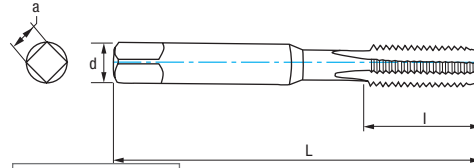

HSS	ISO 529	Tol. 6H		α 10° ± 2		Nº3 Acabado Finishing Finition
-----	---------	---------	--	------------------	--	--------------------------------

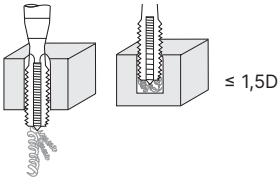

Grupo Group-Groupe	Subgrup. P.1	Grupo Group-Groupe	Grupo Group-Groupe	Subgrup. N.1 - N.3 N.4 - N.5
P		K	N	



M	P	L mm	l mm	d mm	a mm	Z	Nº Art.	€	Nº Art.	€	Nº Art.	€
M1	0,25	38,50	5,50	2,50	2,00	3	29121		29122		29123	
M1,2	0,25	38,50	5,50	2,50	2,00	3	29124		29125		29126	
M1,4	0,30	40,00	7,00	2,50	2,00	3	29127		29128		29129	
M1,6	0,35	41,00	8,00	2,50	2,00	3	29130		29131		29132	
M1,7	0,35	41,00	8,00	2,50	2,00	3	29133		29134		29159	
M1,8	0,35	41,00	8,00	2,50	2,00	3	29160		29162		29164	
M2	0,40	41,00	8,00	2,50	2,00	3	29171		29172		29175	
M2	0,45	41,00	8,00	2,50	2,00	3	29176		29177		29193	
M2,2	0,45	44,50	9,50	2,80	2,24	3	29195		29196		29197	
M2,3	0,45	44,50	9,50	2,80	2,24	3	29199		29211		29212	
M2,5	0,45	44,50	9,50	2,80	2,24	3	29214		29216		29217	
M2,6	0,45	44,50	9,50	2,80	2,24	3	29218		29234		29277	
MF3	0,35	48,00	11,00	3,15	2,50	3	45629		45644		45647	
M3	0,50	48,00	11,00	3,15	2,50	3	29475		29477		29484	
M3	0,60	48,00	11,00	3,15	2,50	3	29494		29633		29846	
MF3,5	0,35	48,00	11,00	3,15	2,50	3					45650	
M3,5	0,60	50,00	13,00	3,55	2,80	3	29861		29862		29865	
MF4	0,50	53,00	13,00	4,00	3,15	3	45659		45662		45665	
M4	0,70	53,00	13,00	4,00	3,15	3	29866		29867		29872	
M4	0,75	53,00	13,00	4,00	3,15	3	29879		29886		29887	
M4,5	0,75	53,00	13,00	4,00	3,15	3	29889		29890		29892	
MF5	0,50	58,00	16,00	5,00	4,00	3	45668		45671		45698	
MF5	0,75	58,00	16,00	5,00	4,00	3	45701		45705		45744	
M5	0,80	58,00	16,00	5,00	4,00	3	29943		29948		29956	
M5	0,90	58,00	16,00	5,00	4,00	3	29957		29966		29973	
M5,5	0,90	62,00	12,00	5,60	4,50	3	29982		29983		29984	
MF6	0,50	66,00	19,00	6,30	5,00	3	45819		45822		45845	
MF6	0,75	66,00	19,00	6,30	5,00	3	45854		45856		45859	
M6	1,00	66,00	19,00	6,30	5,00	3	29986		29987		30006	
MF7	0,75	66,00	19,00	7,10	5,60	3	45869		45875		45878	
M7	1,00	66,00	19,00	7,10	5,60	3	30007		30009		30010	
MF8	0,50	66,00	19,00	8,00	6,30	3	45884		45890		45893	
MF8	0,75	66,00	19,00	8,00	6,30	3	45902		45904		45917	
MF8	1,00	66,00	19,00	8,00	6,30	3	45931		45934		45935	
M8	1,25	66,00	19,00	8,00	6,30	3	30011		30013		30016	
MF9	0,75	66,00	19,00	9,00	7,10	3					45936	
MF9	1,00	72,00	22,00	9,00	7,10	3	45938		45939		45940	
M9	1,25	72,00	22,00	9,00	7,10	3	30017		30018		30020	
MF10	0,50	73,00	20,00	10,00	8,00	3					45942	
MF10	0,75	73,00	20,00	10,00	8,00	3	46031		46034		46037	
MF10	1,00	80,00	24,00	10,00	8,00	3	46040		46043		46046	
MF10	1,25	80,00	24,00	10,00	8,00	3	46049		46052		46055	
M10	1,50	80,00	24,00	10,00	8,00	3	30021		30063		30064	
MF11	0,75	80,00	22,00	8,00	6,30	4	46058		46061		46067	
MF11	1,00	80,00	22,00	8,00	6,30	4	46070		46075		46078	
MF11	1,25	80,00	22,00	8,00	6,30	4					46089	





M	P	L mm	I mm	d mm	a mm	Z	N° Art.	€	N° Art.	€	N° Art.	€
M11	1,50	80,00	22,00	8,00	6,30	4	30065		30066		30067	
MF12	0,75	80,00	22,00	9,00	7,10	4					46091	
MF12	1,00	80,00	22,00	9,00	7,10	4	46093		46095		46098	
MF12	1,25	89,00	29,00	9,00	7,10	4	46101		46103		46104	
MF12	1,50	89,00	29,00	9,00	7,10	4	46105		46155		46156	
M12	1,75	89,00	29,00	9,00	7,10	4	30068		30069		30070	
MF13	1,50	89,00	29,00	9,00	7,10	4					46158	
MF14	1,00	87,00	22,00	11,20	9,00	4	46159		46161		46162	
MF14	1,25	95,00	30,00	11,20	9,00	4	46164		46165		46167	
MF14	1,50	95,00	30,00	11,20	9,00	4	46168		46169		46170	
M14	2,00	95,00	30,00	11,20	9,00	4	30071		30072		30073	
MF15	1,50	95,00	30,00	11,20	9,00	4			46171		46173	
MF16	1,00	92,00	22,00	12,50	10,00	4	46176		46177		46178	
MF16	1,25	102,00	32,00	12,50	10,00	4					46179	
MF16	1,50	102,00	32,00	12,50	10,00	4	46180		46181		46182	
M16	2,00	102,00	32,00	12,50	10,00	4	30074		30075		30076	
MF18	1,00	97,00	22,00	14,00	11,20	4	46183		46184		46315	
MF18	1,50	112,00	37,00	14,00	11,20	4	46327		46348		46525	
MF18	2,00	112,00	37,00	14,00	11,20	4	46531		46540		46631	
M18	2,50	112,00	37,00	14,00	11,20	4	30077		30078		30080	
MF20	1,00	102,00	22,00	14,00	11,20	4	46901		46823		46898	
MF20	1,50	112,00	37,00	14,00	11,20	4	46919		46925		46931	
MF20	2,00	112,00	37,00	14,00	11,20	4	46940		46967		46976	
M20	2,50	112,00	37,00	14,00	11,20	4	30082		30083		30085	
MF22	1,00	118,00	38,00	16,00	12,50	4			46979		46982	
MF22	1,50	118,00	38,00	16,00	12,50	4	46985		46988		46994	
MF22	2,00	118,00	38,00	16,00	12,50	4	46997		47000		47006	
M22	2,50	118,00	38,00	16,00	12,50	4	30086		30087		30088	
MF24	1,00	130,00	45,00	18,00	14,00	4			47012		47015	
MF24	1,50	130,00	45,00	18,00	14,00	4	47018		47021		47024	
MF24	2,00	130,00	45,00	18,00	14,00	4	47027		47033		47036	
M24	3,00	130,00	45,00	18,00	14,00	4	30089		30090		30091	
MF25	1,50	130,00	45,00	18,00	14,00	4	47198		47273		47276	
MF26	1,50	120,00	35,00	18,00	14,00	4			47279		47282	
MF27	1,50	127,00	37,00	20,00	16,00	4			47288		47300	
MF27	2,00	127,00	37,00	20,00	16,00	4					47435	
M27	3,00	127,00	37,00	20,00	16,00	4	30092		30093		30111	
MF28	1,50	127,00	37,00	20,00	16,00	4			47444		47453	
MF30	1,50	127,00	37,00	20,00	16,00	4			47960		47963	
MF30	2,00	127,00	37,00	20,00	16,00	4			47966		47969	
M30	3,50	127,00	37,00	20,00	16,00	4	30112		30113		30115	
MF32	1,50	137,00	37,00	22,40	18,00	4	48092		48095		48098	
MF33	2,00	137,00	37,00	22,40	18,00	4			48104		48107	
M33	3,50	137,00	37,00	22,40	18,00	4	30118		30120		30125	
MF35	1,50	144,00	39,00	25,00	20,00	4			48110		48113	
MF36	1,50	144,00	39,00	25,00	20,00	4					48140	
MF36	2,00	144,00	39,00	25,00	20,00	4			48149		48152	
MF36	3,00	144,00	39,00	25,00	20,00	4			48161		48164	
M36	4,00	144,00	39,00	25,00	20,00	4	30126		30138		30145	
MF39	3,00	170,00	60,00	28,00	22,40	4			48176		48188	
M39	4,00	170,00	60,00	28,00	22,40	4	30146		30147		30148	
MF40	1,50	149,00	39,00	28,00	22,40	4			48191		48194	
MF42	1,50	149,00	39,00	28,00	22,40	4			48197		48200	
MF42	3,00	149,00	39,00	28,00	22,40	4					48203	
M42	4,50	149,00	39,00	28,00	22,40	4	30149		30150		30151	
MF45	1,50	165,00	45,00	31,50	25,00	4			48206		48209	
M45	4,50	165,00	45,00	31,50	25,00	4	30152		30430		30459	
MF48	1,50	165,00	45,00	31,50	25,00	4					48212	
MF48	2,00	165,00	45,00	31,50	25,00	4					48218	
MF48	3,00	165,00	45,00	31,50	25,00	4					48224	
M48	5,00	187,00	67,00	31,50	25,00	4	30487		30493		30494	
MF50	1,50	165,00	45,00	31,50	25,00	4			48284		48287	
M52	5,00	200,00	70,00	35,50	28,00	4					30495	
M56	5,50	200,00	70,00	35,50	28,00	4					30500	



Ref. **3039**

MACHO ÚNICO MANO MÉTRICA / MÉTRICA FINA NORMA ISO
 ISO Standard Metric / Metric Fine Hand Single Tap
 Taraud à main unique métrique / métrique pas fin norme ISO

New!

Ref. 3039 + 1015 Zirkonio



14 Pcs

Cont.	Nº Art. Zirkonio	€
Machos / Taps / Tarauds ISO 529: M3-M4-M5-M6-M8-M10-M12 Brocas / Drill Bits / Forets Zirkonio: 2,5-3,3-4,2-5,0-6,8-8,5-10,2	 26020	



Ref. **3032**

JUEGO MACHOS MANO BSW (WHITWORTH)

BSW (Whitworth) Hand Tap Set
Jeu de tarauds à main BSW (Whitworth)

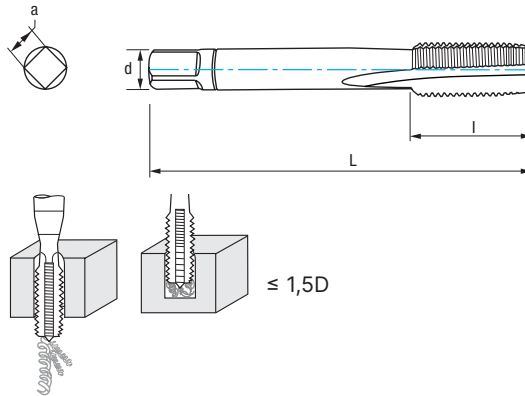

HSS	DIN 352	C 2-3h	α $10^\circ \pm 2$		Rosca Whitworth cilíndrica Straight Whitworth Thread Filetage Whitworth cylindrique
------------	---------	-----------	------------------------------	--	--

Aceros <math><850 \text{ N/mm}^2</math> Steel / Aciers	Fundición Cast Iron Fonte	Cobre Copper Cuivre	Aluminio Aluminium
---	--	----------------------------------	------------------------------

W	Hilos Threads Filets	L mm	l mm	d mm	a mm	Z	Nº Art.	€
W3/32	48,00	36	10	2,80	2,10	3	62663	
W1/8	40,00	40	12	3,50	2,70	3	62642	
W5/32	32,00	45	14	4,50	3,40	3	62675	
W3/16	24,00	50	18	6,00	4,90	3	62660	
W7/32	24,00	50	18	6,00	4,90	3	62684	
W1/4	20,00	50	19	6,00	4,90	3	62633	
W5/16	18,00	56	22	6,00	4,90	4	62669	
W3/8	16,00	70	24	7,00	5,50	4	62654	
W7/16	14,00	70	24	8,00	6,20	4	62681	
W1/2	12,00	75	29	9,00	7,00	4	62630	
W9/16	12,00	80	30	11,00	9,00	4	62687	
W5/8	11,00	80	32	12,00	9,00	4	62666	
W3/4	10,00	95	40	14,00	11,00	4	62645	
W7/8	9,00	100	40	18,00	14,50	4	62678	
W1"	8,00	110	50	18,00	14,50	4	62693	
W1"1/8	7,00	132	56	22,00	18,00	4	62702	
W1"1/4	7,00	132	56	22,00	18,00	4	62699	
W1"3/8	6,00	150	63	28,00	22,00	4	42713	
W1"1/2	6,00	150	63	32,00	24,00	4	62696	
W1"5/8	5,00	160	70	32,00	24,00	4	59880	
W1"3/4	5,00	160	70	36,00	29,00	6	59881	
W1"7/8	4,50	190	80	36,00	29,00	6	59882	
W2"	4,50	190	80	40,00	32,00	6	59883	



Ref. **3012**

MACHO ÚNICO MANO BSW (WHITWORTH)

BSW (Whitworth) Hand Tap

Taraud à main BSW (Whitworth)

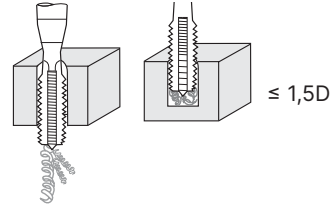
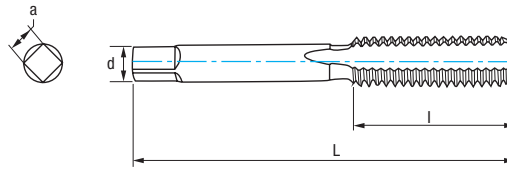

HSS

DIN 352

C
2-3h

α
 $10^\circ \pm 2$



Rosca Whitworth cilíndrica
Straight Whitworth Thread
Filetage Whitworth cylindrique

Nº3 Acabado
Finishing
Finition

Aceros
<850 N/mm²
Steel / Aciers

Fundición
Cast Iron
Fonte

Cobre
Copper
Cuivre

Aluminio
Aluminium

W	Hilos Threads	Filets	L mm	l mm	d mm	a mm	Z	Nº Art.	€
W3/32	48,00		40	9	2,80	2,10	3	75404	
W1/8	40,00		40	14	3,50	2,70	3	75401	
W5/32	32,00		45	17	4,50	3,40	3	75069	
W3/16	24,00		50	19	6,00	4,90	3	74825	
W7/32	24,00		50	19	6,00	4,90	3	75409	
W1/4	20,00		50	20	6,00	4,90	3	75400	
W5/16	18,00		56	20	6,00	4,90	4	75406	
W3/8	16,00		63	22	7,00	5,50	4	75403	
W7/16	14,00		70	22	8,00	6,20	4	75408	
W1/2	12,00		75	25	9,00	7,00	4	75399	
W9/16	12,00		80	26	11,00	9,00	4	75448	
W5/8	11,00		80	27	12,00	9,00	4	75405	
W3/4	10,00		95	32	14,00	11,00	4	75402	
W7/8	9,00		100	32	18,00	14,50	4	75407	
W1"	8,00		110	36	18,00	14,50	4	75410	
W1" 1/8	7,00		125	40	22,00	18,00	4	76255	
W1" 1/4	7,00		125	40	22,00	18,00	4	76259	
W1" 3/8	6,00		150	50	28,00	22,00	4	76264	
W1" 1/2	6,00		150	50	32,00	24,00	4	76269	
W1" 5/8	5,00		150	56	32,00	24,00	4	76274	
W1" 3/4	5,00		160	58	36,00	29,00	4	76280	
W1" 7/8	4,50		180	65	36,00	29,00	4	76286	
W2"	4,50		180	65	40,00	32,00	4	76291	



Ref. **3026**

JUEGO MACHOS MANO BSP (GAS)

BSP (Gas) Hand Tap Set
Jeu tarauds à main BSP (Gaz)

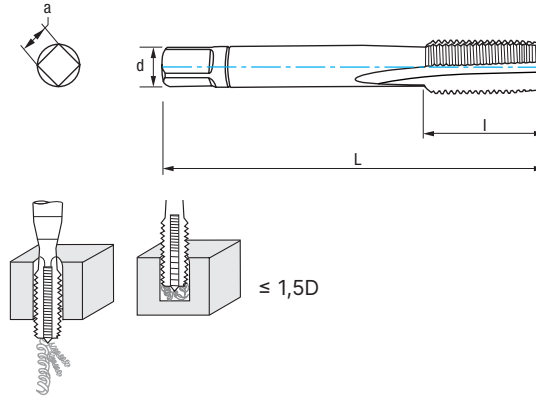

HSS	DIN 5157	ISO 2284	B 3,5-5h	C 2-3h		α $10^\circ \pm 2$		Rosca Whitworth Paralela (BSPP) Whitworth Parallel Thread (BSPP) Filetage Whitworth Parallèle (BSPP)
------------	----------	----------	-------------	-----------	--	------------------------------	--	---

Aceros <850 N/mm ² Steel / Aciers	Fundición Cast Iron Fonte	Cobre Copper Cuivre	Aluminio Aluminium
---	--	----------------------------------	------------------------------



DIN 5157	Nº1 Desbaste Roughing Ébauche	Nº3 Acabado Finishing Finition
----------	--	---

Nº1 **B**
3,5-5h

Nº3 **C**
2-3h

G	Hilos Threads Filets	L mm	l mm	d mm	a mm	Z	Nº Art.	€
G1/8	28	63	20	7,00	5,50	4	62510	
G1/4	19	70	22	11,00	9,00	4	62504	
G3/8	19	70	22	12,00	9,00	4	62516	
G1/2	14	80	22	16,00	12,00	4	62498	
G5/8	14	80	22	18,00	14,50	4	62522	
G3/4	14	90	22	20,00	16,00	4	62513	
G7/8	14	90	22	22,00	18,00	4	62525	
G1"	11	100	25	25,00	20,00	4	62528	
G1" 1/8	11	125	40	28,00	22,00	4	76195	
G1" 1/4	11	125	40	32,00	24,00	4	76203	
G1" 3/8	11	125	40	36,00	29,00	4	76211	
G1" 1/2	11	140	40	36,00	29,00	6	74823	
G1" 3/4	11	140	40	40,00	32,00	6	76225	
G2"	11	160	40	45,00	35,00	8	76231	

New!

ISO 2284	Nº3 Acabado Finishing Finition
----------	---

Nº3 **B**
3,5-5h

Nº3 **C**
2-3h

G	Hilos Threads Filets	L mm	l mm	d mm	a mm	Z	Nº Art.	€
G1/8	28	59	15	8,00	6,30	4	26780	
G1/4	19	67	19	10,00	8,00	4	26789	
G3/8	19	75	21	12,50	10,00	4	26814	
G1/2	14	87	26	16,00	12,50	4	26830	
G5/8	14	91	26	18,00	14,00	4	26845	
G3/4	14	96	28	20,00	16,00	4	26852	
G7/8	14	102	29	22,40	18,00	6	26857	
G1"	11	109	33	25,00	20,00	6	26860	
G1" 1/8	11	116	34	28,00	22,40	6	26891	
G1" 1/4	11	119	36	31,50	25,00	6	26950	
G1" 3/8	11	120	36	31,50	25,00	6	26954	
G1" 1/2	11	125	37	35,50	28,00	6	26973	
G1" 3/4	11	132	39	35,50	28,00	6	26988	
G2"	11	140	41	40,00	31,50	6	27002	



Ref. **3016**

MACHO ÚNICO MANO BSP (GAS)

BSP (Gas) Hand Tap
Taraud à main BSP (Gaz)

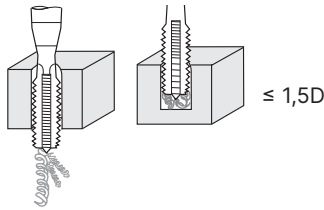
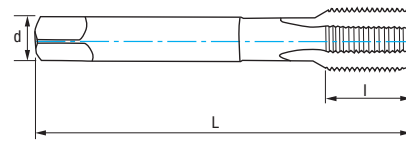

HSS	DIN 5157	ISO 2284		α $10^\circ \pm 2$	 Rosca Whitworth Paralela (BSPP) Whitworth Parallel Thread (BSPP) Filetage Whitworth Parallèle (BSPP)	N°3 Acabado Finishing Finition
------------	----------	----------	--	------------------------------	---	--

Aceros <math><850 \text{ N/mm}^2</math> Steel / Aciers	Fundición Cast Iron Fonte	Cobre Copper Cuivre	Aluminio Aluminium
---	--	----------------------------------	------------------------------



N°3



DIN 5157

G	Entrada Chamfer Entrée	Hilos Threads Filets	L mm	I mm	d mm	a mm	Z	N° Art.	€
G1/8		28	63	20	7,00	5,50	3	75461	
G1/4		19	70	22	11,00	9,00	4	75460	
G3/8		19	70	22	12,00	9,00	4	75462	
G1/2		14	80	22	16,00	12,00	4	75459	
G5/8		14	80	22	18,00	14,50	4	75463	
G3/4		14	90	22	20,00	16,00	4	75106	
G7/8		14	90	22	22,00	18,00	4	76246	
G1"	C	11	100	25	25,00	20,00	4	75464	
G1" 1/8		11	125	40	28,00	22,00	4	76196	
G1" 1/4		11	125	40	32,00	24,00	4	76204	
G1" 3/8		11	140	40	36,00	29,00	4	76212	
G1" 1/2		11	140	40	36,00	29,00	6	76218	
G1" 3/4		11	140	40	40,00	32,00	6	76226	
G2"		11	160	40	45,00	35,00	8	76232	

New!

ISO 2284

G	Entrada Chamfer Entrée	Hilos Threads Filets	L mm	I mm	d mm	a mm	Z	N° Art.	€
G1/8	B	28	59	15	8,00	6,30	4	26759	
	C							26779	
G1/4	B	19	67	19	10,00	8,00	4	26781	
	C							26783	
G3/8	B	19	75	21	12,50	10,00	4	26790	
	C							26791	
G1/2	B	14	87	26	16,00	12,50	4	26823	
	C							26827	
G5/8	B	14	91	26	18,00	14,00	4	26832	
	C							26843	
G3/4	B	14	96	28	20,00	16,00	4	26849	
	C							26850	
G7/8	B	11	102	29	22,40	18,00	6	26853	
	C							26855	
G1"	B	11	109	33	25,00	20,00	6	26858	
	C							26859	
G1" 1/8	B	11	116	34	28,00	22,40	6	26862	
	C							26873	
G1" 1/4	B	11	119	36	31,50	25,00	6	26941	
	C							26948	
G1" 3/8	B	11	120	36	31,50	25,00	6	26951	
	C							26953	
G1" 1/2	B	11	125	37	35,50	28,00	6	26956	
	C							26971	
G1" 3/4	B	11	132	39	35,50	28,00	6	26974	
	C							26976	
G2"	B	11	140	41	40,00	31,50	8	26991	
	C							26997	

N°3



Ref. **3100**

MACHO RECTO MÁQUINA MÉTRICA MANGO REFORZADO

Reinforced Shank Metric Machine Straight Tap
Taraud droit machine métrique queue renforcée

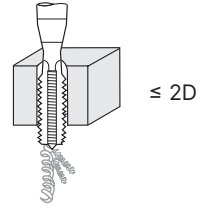
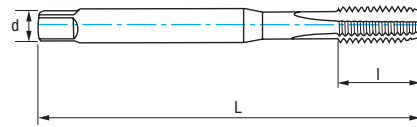

HSSE
5% Co

DIN
371

Reforzado
Reinforced
Renforcée



Tol.
6H

α
 $10^\circ \pm 2$

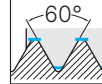

Aceros
<math><850 \text{ N/mm}^2</math>
Steel / Aciers

Cobre
Copper
Cuivre

Aluminio
Aluminium



M	P	L mm	l mm	d mm	a mm	Z	Nº Art.	€
M2	0,40	45	9	2,80	2,10	3	62771	
M2,5	0,45	50	9	2,80	2,10	3	76724	
M2,6	0,45	50	9	2,80	2,10	3	76725	
M3	0,50	56	11	3,50	2,70	3	62774	
M3,5	0,60	56	13	4,00	3,00	3	62777	
M4	0,70	63	13	4,50	3,40	3	62780	
M4,5	0,75	70	16	6,00	4,90	3	76728	
M5	0,80	70	16	6,00	4,90	3	62783	
M6	1,00	80	19	6,00	4,90	3	62789	
M7	1,00	80	19	7,00	5,50	3	76733	
M8	1,25	90	22	8,00	6,20	3	62795	
M9	1,25	90	18	9,00	7,00	3	62798	
M10	1,50	100	24	10,00	8,00	3	62807	



Expo 25 Pcs

Cont. Ø	Nº Art.	€
Machos / Taps / Tarauds DIN 371: M4-M5-M6-M8- M10 (5 pcs x M)	38998	

Set Ref. 3100

7 Pcs



Cont. Ø	Nº Art.	€
Machos / Taps / Tarauds DIN 371: M3-M4-M5- M6-M8-M10 + DIN 376: M12	43348	

Set Ref. 3100 + 1010 HSS

14 Pcs



Cont. Ø	Nº Art.	€
Machos / Taps / Tarauds DIN 371: M3-M4-M5- M6-M8-M10 + DIN 376: M12	43354	
Brocas / Drill Bits / Forets HSS: 2,5-3,3-4,2-5,0-6,8-8,5- 10,2		

Set Ref. 3100 + 1016 HSSE

14 Pcs



Cont. Ø	Nº Art.	€
Machos / Taps / Tarauds DIN 371: M3-M4-M5- M6-M8-M10 + DIN 376: M12	21801	
Brocas / Drill Bits / Forets HSSE: 2,5-3,3-4,2-5,0-6,8-8,5- 10,2		

Set Ref. 3100 + 1015 Zirkonio

14 Pcs



New!

Cont. Ø	Nº Art.	€
Machos / Taps / Tarauds DIN 371: M3-M4-M5- M6-M8-M10 + DIN 376: M12	56424	
Brocas / Drill Bits / Forets Zirkonio: 2,5-3,3-4,2-5,0-6,8-8,5- 10,2		



Ref. **3200**

MACHO RECTO MÁQUINA MÉTRICA/ MÉTRICA FINA

Metric / Metric Fine Machine Straight Tap

Taraud droit machine métrique / métrique pas fin

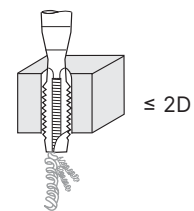
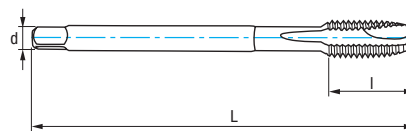

HSSE
5% Co

M
DIN
376

MF
DIN
374

B
3,5-5h



Tol.
6H

α
 $10^\circ \pm 2$

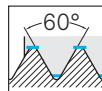

Aceros
<math><850 \text{ N/mm}^2</math>
Steel / Aciers

Cobre
Copper
Cuivre

Aluminio
Aluminium



M/MF	P	L mm	I mm	d mm	a mm	Z	Nº Art.	€
M3	0,50	56	11	2,20			70090	
M4	0,70	63	13	2,80	2,10	3	70092	
M5	0,80	70	16	3,50	2,70	3	70093	
M6	1,00	80	19	4,50	3,40	3	70095	
M7	1,00	80	19	5,50	4,30	3	70224	
MF8	0,75	80	19	6,00	4,90	3	70267	
MF8	1,00	90	22	6,00	4,90	3	70248	
M8	1,25	90	22	6,00	4,90	3	70096	
MF10	1,00	90	20	7,00	5,50	3	70249	
MF10	1,25	100	24	7,00	5,50	3	70251	
M10	1,50	100	24	7,00	5,40	3	70098	
M11	1,50	100	24	8,00	6,20	3	70225	
MF12	1,00	100	22	9,00	7,00	3	70252	
MF12	1,25	100	22	9,00	7,00	3	70254	
MF12	1,50	100	22	9,00	7,00	3	70255	
M12	1,75	110	29	9,00	7,00	3	70183	
MF14	1,00	100	22	11,00	9,00	3	70281	
MF14	1,25	100	22	11,00	9,00	3	70257	
MF14	1,50	100	22	11,00	9,00	3	70258	
M14	2,00	110	30	11,00	9,00	3	70185	
MF15	1,50	100	22	12,00	9,00	3	70282	
MF16	1,50	100	22	12,00	9,00	3	70260	
M16	2,00	110	32	12,00	9,00	3	70186	
MF18	1,00	110	25	14,00	11,00	3	70284	
MF18	1,50	110	25	14,00	11,00	3	70261	
MF18	2,00	125	34	14,00	11,00	3	70285	
M18	2,50	125	34	14,00	11,00	3	75215	
MF20	1,00	125	25	16,00	12,00	3	70287	
MF20	1,50	125	25	16,00	12,00	3	70263	
MF20	2,00	140	34	16,00	12,00	3	70288	
M20	2,50	140	34	16,00	12,00	3	70189	
MF22	1,50	125	25	18,00	14,50	3	75216	
MF22	2,00	140	34	18,00	14,50	3	70290	

M/MF	P	L mm	I mm	d mm	a mm	Z	Nº Art.	€
M22	2,50	140	34	18,00	14,50	3	70212	
MF24	1,50	140	28	18,00	14,50	4	70264	
MF24	2,00	140	28	18,00	14,50	4	70291	
M24	3,00	160	38	18,00	14,50	4	70213	
MF26	1,50	140	28	18,00	14,50	4	70293	
MF27	2,00	140	28	20,00	16,00	4	70294	
M27	3,00	160	38	20,00	16,00	4	70215	
MF28	1,50	140	28	20,00	16,00	4	70296	
MF30	1,50	150	28	22,00	18,00	4	70266	
M30	3,50	180	45	22,00	18,00	4	70216	
MF32	1,50	150	28	22,00	18,00	4	70297	
MF33	1,50	160	30	25,00	20,00	4	70299	
MF33	2,00	160	30	25,00	20,00	4	70300	
M33	3,50	180	50	25,00	20,00	4	70218	
MF35	1,50	170	30	28,00	22,00	4	70302	
MF36	1,50	170	30	28,00	22,00	4	81355	
MF36	2,00	170	30	28,00	22,00	4	81356	
MF36	3,00	200	42	28,00	22,00	4	81357	
M36	4,00	200	56	28,00	22,00	4	70219	
MF39	1,50	170	30	32,00	24,00	4	81358	
MF39	2,00	170	30	32,00	24,00	4	81359	
MF39	3,00	200	42	32,00	24,00	4	81360	
M39	4,00	200	50	32,00	24,00	4	81361	
MF42	1,50	170	30	32,00	24,00	4	81362	
MF42	2,00	170	30	32,00	24,00	4	81363	
MF42	3,00	200	50	32,00	24,00	4	81364	
M42	4,50	200	56	32,00	24,00	4	14886	
MF45	1,50	180	32	36,00	29,00	6	70303	
M45	4,50	220	56	36,00	29,00	6	81365	
M48	5,00	250	63	36,00	29,00	6	81366	
M52	5,00	250	63	40,00	32,00	6	81367	
M56	5,50	250	65	40,00	32,00	6	81368	
M60	5,50	280	75	45,00	35,00	6	81369	



Expo 25 Pcs

Cont.	Nº Art.	€
Machos / Taps / Tarauds DIN 376: M4-M5-M6-M8- M10 (5 pcs x M)	39000	



Ref. **3150**

MACHO HELICOIDAL MÁQUINA MÉTRICA MANGO REFORZADO

Reinforced Shank Metric Machine Spiral Tap

Taraud hélicoïdal machine métrique queue renforcée

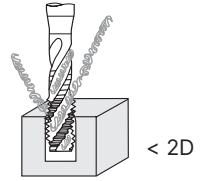
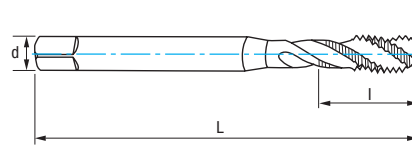

HSSE 5% Co	DIN 371	Reforzado Reinforced Renforcée	C 2-3h	35°	α $10^\circ \pm 2$	60°
----------------------	------------	---	-----------	-----	------------------------------	-----

Aceros <850 N/mm ² Steel / Aciers	Cobre Copper Cuivre	Aluminio Aluminium
---	----------------------------------	------------------------------

M	P	L mm	l mm	d mm	a mm	Z	Nº Art.	€
M3	0,50	56	5	3,50	2,70	3	63050	
M3,5	0,60	56	6	4,00	3,00	3	63053	
M4	0,70	63	7	4,50	3,40	3	63056	
M5	0,80	70	8	6,00	4,90	3	63059	
M6	1,00	80	10	6,00	4,90	3	63062	
M7	1,00	80	10	7,00	5,50	3	63065	
M8	1,25	90	13	8,00	6,20	3	63071	
M9	1,25	90	13	9,00	7,00	3	67882	
M10	1,50	100	15	10,00	8,00	3	63083	



Expo 25 Pcs

Cont. Ø	Nº Art.	€
Machos / Taps / Tarauds DIN 371: M4-M5-M6-M8-M10 (5 pcs x M)	38999	

Set Ref. 3150

7 Pcs



Cont. Ø	Nº Art.	€
Machos / Taps / Tarauds DIN 371: M3-M4-M5-M6-M8-M10 + DIN 376: M12	43353	



Set Ref. 3150 + 1010 HSS

14 Pcs

Cont. Ø	Nº Art.	€
Machos / Taps / Tarauds DIN 371: M3-M4-M5-M6-M8-M10 + DIN 376: M12	43359	
Brocas / Drill Bits / Forets HSS: 2,5-3,3-4,2-5,0-6,8-8,5-10,2		

Set Ref. 3150 + 1016 HSSE

14 Pcs



Cont. Ø	Nº Art.	€
Machos / Taps / Tarauds DIN 371: M3-M4-M5-M6-M8-M10 + DIN 376: M12	21802	
Brocas / Drill Bits / Forets HSSE: 2,5-3,3-4,2-5,0-6,8-8,5-10,2		

Set Ref. 3150 + 1015 Zirkonio

14 Pcs



Cont. Ø	Nº Art.	€
Machos / Taps / Tarauds DIN 371: M3-M4-M5-M6-M8-M10 + DIN 376: M12	56428	
Brocas / Drill Bits / Forets Zirkonio: 2,5-3,3-4,2-5,0-6,8-8,5-10,2		



Ref. **3250**

MACHO HELICOIDAL MÁQUINA MÉTRICA / MÉTRICA FINA

Metric / Metric Fine Machine Spiral Tap

Taraud hélicoïdal machine métrique / métrique pas fin

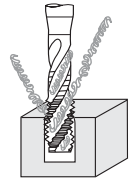
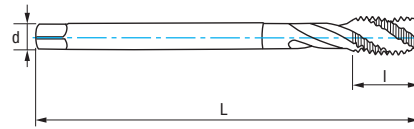

< 2D

HSSE 5% Co	M DIN 376	MF DIN 374	C 2-3h	Tol. 6H		α $10^\circ \pm 2$	
----------------------	-----------------	---------------	-----------	------------	--	------------------------------	--

Aceros <850 N/mm ² Steel / Aciers	Cobre Copper Cuivre	Aluminio Aluminium
---	----------------------------------	------------------------------



M/MF	P	L mm	l mm	d mm	a mm	Z	Nº Art.	€
M3	0,50	56	5	2,20		3	70063	
M4	0,70	63	7	2,80	2,10	3	70065	
M5	0,80	70	8	3,50	2,70	3	70066	
M6	1,00	80	10	4,50	3,40	3	70068	
MF8	1,00	90	13	6,00	4,90	3	70228	
M8	1,25	90	13	6,00	4,90	3	70069	
MF10	1,00	90	12	7,00	5,50	3	70230	
MF10	1,25	100	15	7,00	5,50	3	70231	
M10	1,50	100	15	7,00	5,50	3	70071	
MF12	1,00	100	14	9,00	7,00	3	70233	
MF12	1,25	100	14	9,00	7,00	3	70234	
MF12	1,50	100	14	9,00	7,00	3	70236	
M12	1,75	110	18	9,00	7,00	3	70161	
MF14	1,25	100	16	11,00	9,00	3	70237	
MF14	1,50	100	16	11,00	9,00	3	70239	
M14	2,00	110	20	11,00	9,00	3	70162	
MF16	1,50	100	16	12,00	9,00	3	70240	
M16	2,00	110	20	12,00	9,00	4	70164	
MF18	1,50	110	20	14,00	11,00	4	70242	
M18	2,50	125	25	14,00	11,00	4	75057	
MF20	1,50	125	20	16,00	12,00	4	70243	
M20	2,50	140	25	16,00	12,00	4	70167	
MF22	1,50	125	20	18,00	14,50	4	75192	
M22	2,50	140	25	18,00	14,50	4	70206	
MF24	1,50	140	22	18,00	14,50	4	70245	
MF24	2,00	140	28	18,00	14,50	4	24326	
M24	3,00	160	30	18,00	14,50	4	70207	
New! MF27	2,00	140	28	20,00	16,00	4	71566	
M27	3,00	160	30	20,00	16,00	4	70209	
MF30	1,50	150	28	22,00	18,00	4	70246	
M30	3,50	180	35	22,00	18,00	4	70210	



Expo 25 Pcs

Cont. Ø	Nº Art.	€
Machos / Taps / Tarauds DIN 376: M4-M5-M6-M8- M10 (5 pcs x M)	39001	



Ref. **3119**

MACHO RECTO MÁQUINA MÉTRICA NORMA ISO 529

ISO 529 Norm Standard Metric Machine Straight Tap

Taraud droit machine métrique norme ISO 529

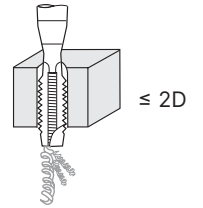
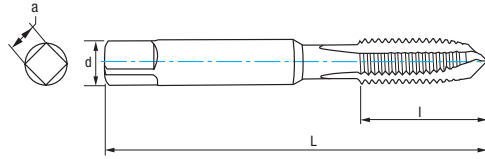

HSSE 5% Co	ISO 529	B 3,5-5h	Tol. 6H	GUN	α $10^\circ \pm 2$	60°	Vaporizado Vaporized Vaporisée
----------------------	-------------------	--------------------	------------	------------	------------------------------	------------	---

Aceros <math><850 \text{ N/mm}^2</math> Steel / Aciers	INOX Stainless Steel Acier INOX	Cobre Copper Cuivre	Aluminio Aluminium
---	--	----------------------------------	------------------------------



	M	P	L mm	l mm	d mm	a mm	Z	Nº Art.	€
New!	M2	0,40	41	8	2,50	2,00	2	77478	
New!	M2,5	0,45	44	9,5	2,80	2,24	2	77479	
	M3	0,50	48	11	3,15	2,50	3	69558	
New!	M3,5	0,60	53	13	4,00	3,15	3	69562	
	M4	0,70	53	13	4,00	3,15	3	69567	
New!	M4,5	0,75	58	16	5,00	4,00	3	69570	
	M5	0,80	58	16	5,00	4,00	3	69575	
	M6	1,00	66	19	6,30	5,00	3	69582	
New!	M7	1,00	66	19	6,30	5,00	3	69583	
	M8	1,25	72	22	8,00	6,30	3	69586	
	M10	1,50	80	24	10,00	8,00	3	69588	
	M12	1,75	89	29	9,00	7,10	3	69607	
	M14	2,00	95	30	11,20	9,00	3	69608	
	M16	2,00	102	32	12,50	10,00	3	69610	
	M18	2,50	112	37	14,00	11,20	3	69611	
	M20	2,50	112	37	14,00	11,20	3	69613	
	M22	2,50	118	38	16,00	12,50	3	69614	
	M24	3,00	130	45	18,00	14,00	3	69616	
	M27	3,00	135	45	20,00	16,00	3	69617	
	M30	3,50	138	48	20,00	16,00	3	69619	

Línea 33 cm - Ref. 3119

26 cm



\varnothing	M3	M5	M6	M8	M10
Pcs	3	3	3	3	3
Ref. 4995 - Nº Art. 70993:					€



Ref. **3113**

MACHO HELICOIDAL MÁQUINA MÉTRICA NORMA ISO 529

ISO 529 Standard Metric Machine Spiral Tap

Taraud hélicoïdal machine métrique norme ISO 529

New!

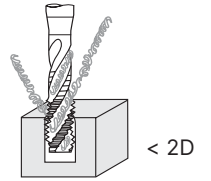
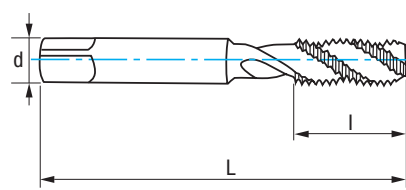

HSSE
5% Co

ISO
529



Tol.
6H



α
12-14°



Vaporizado
Vaporized
Vaporisée

Aceros
<850 N/mm²
Steel / Aciers

Cobre
Copper
Cuivre

Aluminio
Aluminium



M	P	L mm	l mm	d mm	a mm	Z	N° Art.	€
M2	0,40	41	8	2,50	2,00	2	48989	
M2,5	0,45	44	9,5	2,80	2,24	2	48992	
M3	0,50	48	6	3,15	2,50	3	49004	
M3,5	0,60	50	6	3,55	2,80	3	49016	
M4	0,70	53	7	4,00	3,15	3	49019	
M5	0,80	58	8	5,00	4,00	3	49022	
M6	1,00	66	10	6,30	5,00	3	49025	
M7	1,00	66	13	7,10	5,60	3	49028	
M8	1,25	72	12	8,00	6,30	3	49031	
M10	1,50	80	15	10,00	8,00	3	49034	
M12	1,75	89	16	9,00	7,10	3	49187	
M14	2,00	95	18	11,20	9,00	3	49190	
M16	2,00	102	18	12,50	10,00	4	49193	
M18	2,50	112	29	14,00	11,20	4	49196	
M20	2,50	112	29	14,00	11,20	4	49199	
M22	2,50	118	29	16,00	12,50	4	49202	
M24	3,00	130	35	18,00	14,00	4	49205	
M27	3,00	135	35	20,00	16,00	4	77480	
M30	3,50	138	42	20,00	16,00	4	77481	



Ref. **3109**

MACHO RECTO MÁQUINA MÉTRICA NORMA ISO 529

ISO 529 Norm Standard Metric Machine Straight Tap

Taraud droit machine métrique norme ISO 529

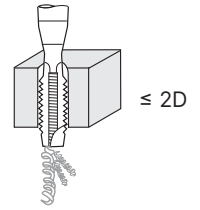
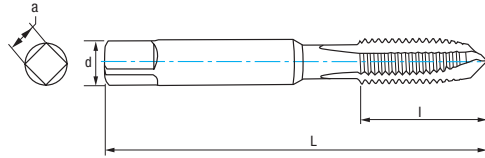

HSS	ISO 529	B 3,5-5h	Tol. 6H	GUN	α $10^\circ \pm 2$	60°
------------	----------------	--------------------	------------	------------	------------------------------	------------

Aceros
<850 N/mm²
Steel / Aciers

Cobre
Copper
Cuivre

Aluminio
Aluminium



New!

M	P	L mm	l mm	d mm	a mm	Z	Nº Art.	€	Nº Art. TIN	€
M3	0,50	48	11	3,15	2,50	3	38180		31717	
M3,5	0,60	53	13	4,00	3,15	3	38181		70208	
M4	0,70	53	13	4,00	3,15	3	38182		31718	
M4,5	0,75	58	16	5,00	4,00	3	38183		70229	
M5	0,80	58	16	5,00	4,00	3	38373		31719	
M6	1,00	66	19	6,30	5,00	3	38185		31720	
M7	1,00	66	19	6,30	5,00	3	38186		70235	
M8	1,25	72	22	8,00	6,30	3	38187		31721	
M10	1,50	80	24	10,00	8,00	3	38188		31722	
M12	1,75	89	29	9,00	7,10	3	38189		31729	
M14	2,00	95	30	11,20	9,00	3	38190		31730	
M16	2,00	102	32	12,50	10,00	3	38191		31732	
M18	2,50	112	37	14,00	11,20	3	38192		31734	
M20	2,50	112	37	14,00	11,20	3	38193		31736	
M22	2,50	118	38	16,00	12,50	3	38194		31737	
M24	3,00	130	45	18,00	14,00	3	38195		31746	
M27	3,00	135	45	20,00	16,00	3	38196		31747	
M30	3,50	138	48	20,00	16,00	3	38197		31748	
New! M33	3,50	151	51	22,40	18,00	4	31585		31749	
New! M36	4,00	162	57	25,00	20,00	4	31588		31751	
New! M39	4,00	170	60	28,00	22,40	4	31605		31752	
New! M42	4,50	170	60	28,00	22,40	4	31607		31753	
New! M45	4,50	187	67	31,50	25,00	4	31609		31754	
New! M48	5,00	187	67	31,50	25,00	4	31616		31755	



Línea 33 cm - Ref. 3109 -1-



∅	M3	M5	M6	M8	M10
Pcs	3	3	3	3	3

Ref. 4995 - N° Art. 71560: €

Línea 33 cm - Ref. 3109 -2-



∅	M12	M14	M16	M18	M20
Pcs	3	3	3	3	3

Ref. 4995 - N° Art. 71563: €



Ref. **3157**

MACHO HELICOIDAL MÁQUINA MÉTRICA NORMA ISO 529

ISO 529 Norm Standard Metric Machine Spiral Tap

Taraud hélicoïdal machine métrique norme ISO 529

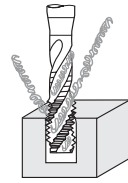
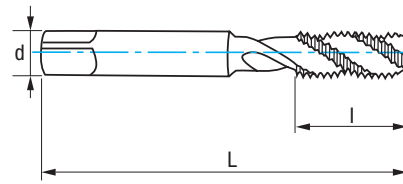

< 2D

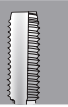

HSS

ISO 529



Tol. 6H

α 12-14°



Aceros
 <850 N/mm²
 Steel / Aciers

Cobre
 Copper
 Cuivre

Aluminio
 Aluminium



New!

M	P	L mm	l mm	d mm	ϕ mm	Z	N° Art.	€	N° Art. TIN	€
M3	0,50	48	11	3,15	2,50	3	38198		31723	
M3,5	0,60	53	13	4,00	3,15	3	38199		70194	
M4	0,70	53	13	4,00	3,15	3	38201		31724	
M5	0,80	58	16	5,00	4,00	3	38206		31725	
M6	1,00	66	19	6,30	5,00	3	38209		12168	
M7	1,00	66	19	6,30	5,00	3	38211		70197	
M8	1,25	72	22	8,00	6,30	3	38214		31726	
M10	1,50	80	24	10,00	8,00	3	38216		31728	
M12	1,75	89	29	9,00	7,10	3	38226		31756	
M14	2,00	95	30	11,20	9,00	3	38228		31757	
M16	2,00	102	32	12,50	10,00	3	38229		31758	
New! M18	2,50	112	37	14,00	11,20	4	31627		31759	
New! M20	2,50	118	38	16,00	12,50	4	31629		31760	
New! M22	2,50	130	45	18,00	14,00	4	31630		31761	
New! M24	3,00	135	45	20,00	16,00	4	31634		31762	
New! M27	3,00	138	48	20,00	16,00	4	31635		31763	
New! M30	3,50	151	51	22,40	18,00	4	31638		31764	
New! M33	3,50	162	57	25,00	20,00	4	31586		31766	
New! M36	4,00	170	60	28,00	22,40	4	31604		31767	
New! M39	4,00	170	60	28,00	22,40	4	31606		31768	
New! M42	4,50	187	67	31,50	25,00	4	31608		31769	
New! M45	4,50	187	67	31,50	25,00	4	31612		31772	
New! M48	5,00	187	67	31,50	25,00	4	31620		31775	



Línea 33 cm - Ref. 3157 -1-

26
cm



∅	M3	M5	M6	M8	M10
Pcs	3	3	3	3	3

Ref. 4995 - N° Art. 70997: €

Línea 33 cm - Ref. 3157 -2-

26
cm



∅	M12	M14	M16
Pcs	3	3	3

Ref. 4995 - N° Art. 72127: €



Ref. **3103**

MACHO RECTO MÁQUINA UNC NORMA ISO 529

ISO 529 Norm Standard UNC Machine Straight Tap

Taraud droit machine UNC norme ISO 529

New!

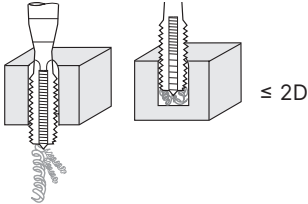
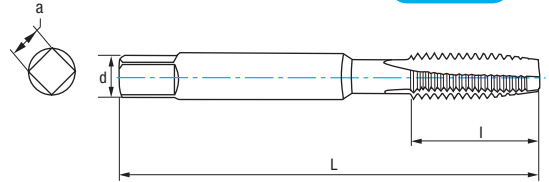

UNC	Hilos Threads Filets	L mm	l mm	d mm	a mm	Z	Nº Art.	€	Nº Art.	€
UNC Nº1	64	41	8	2,50	2,00	3	62989		62990	
UNC Nº2	56	45	10	2,80	2,24	3	62991		62992	
UNC Nº3	48	45	10	2,80	2,24	3	62994		62995	
UNC Nº4	40	48	11	3,15	2,50	3	62996		62997	
UNC Nº5	40	48	11	3,15	2,50	3	62998		62999	
UNC Nº6	32	50	13	3,55	2,80	3	63000		63001	
UNC Nº8	32	53	13	4,50	3,55	3	63003		63004	
UNC Nº10	24	58	16	5,00	4,00	3	63006		63007	
UNC Nº12	24	62	17	5,60	4,50	3	63009		63012	
UNC 1/4	20	66	19	6,30	5,00	3	63016		63018	
UNC 5/16	18	72	22	8,00	6,30	3	63019		63021	
UNC 3/8	16	80	24	10,00	8,00	3	63022		63027	
UNC 7/16	14	85	25	8,00	6,30	3	63028		63030	
UNC 1/2	13	89	29	9,00	7,10	3	63031		63033	
UNC 9/16	12	95	30	11,20	9,00	3	63034		63036	
UNC 5/8	11	102	32	12,50	10,00	3	63038		63039	
UNC 3/4	10	112	37	14,00	11,20	3	63040		63042	
UNC 7/8	9	118	38	16,00	12,50	3	63043		63045	
UNC 1"	8	130	45	18,00	14,00	3	63046		63047	
UNC 1"1/8	7	138	48	20,00	16,00	4	63048		63049	
UNC 1"1/4	7	151	51	22,40	18,00	4	63051		63052	
UNC 1"3/8	6	162	57	25,00	20,00	4	63054		63057	
UNC 1"1/2	6	170	60	28,00	22,40	4	63058		63060	
UNC 1"3/4	5	187	67	31,50	25,00	4	63061		63063	
UNC 2"	4	200	70	35,50	28,00	4	63064		63066	



Ref. **3123**

MACHO RECTO MÁQUINA UNF NORMA ISO 529

ISO 529 Norm Standard UNF Machine Straight Tap

Taraud droit machine UNF norme ISO 529

New!

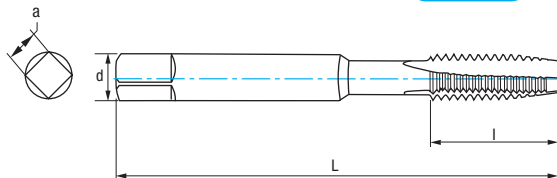

HSS
ISO 529
B 3,5-5h
C 2-3h
Tol. 6H
GUN
 α 10-12°
60°

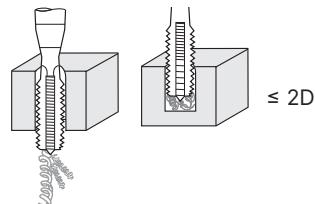

UNF	Hilos Threads	Filets	L mm	l mm	d mm	a mm	Z	N° Art.	€	N° Art.	€
UNF N°0	80		41	8	2,50	2,00	3	63067		66203	
UNF N°1	72		41	8	2,50	2,00	3	63069		66205	
UNF N°2	64		45	10	2,80	2,24	3	63070		66398	
UNF N°3	56		45	10	2,80	2,24	3	84231		84232	
UNF N°4	48		48	11	3,15	2,50	3	63072		66410	
UNF N°5	44		48	11	3,15	2,50	3	63075		66413	
UNF N°6	40		50	13	3,55	2,80	3	63076		66509	
UNF N°8	36		53	13	4,50	3,55	3	63079		66512	
UNF N°10	32		58	16	5,00	4,00	3	63112		66566	
UNF N°12	28		62	17	5,60	4,50	3	63171		66596	
UNF 1/4	28		66	19	6,30	5,00	3	63172		66722	
UNF 5/16	24		72	22	8,00	6,30	3	63173		66728	
UNF 3/8	24		80	24	10,00	8,00	3	63174		67163	
UNF 7/16	20		85	25	8,00	6,30	3	63175		67169	
UNF 1/2	20		89	29	9,00	7,10	3	63177		67349	
UNF 9/16	18		95	30	11,20	9,00	3	63180		67358	
UNF 5/8	18		102	32	12,50	10,00	3	63181		67359	
UNF 3/4	16		112	37	14,00	11,20	3	63184		67361	
UNF 7/8	14		118	38	16,00	12,50	3	63213		67364	
UNF 1"	12		130	45	18,00	14,00	3	63326		67370	
UNF 1"1/8	12		127	37	20,00	16,00	4	63389		67373	
UNF 1"1/4	12		137	37	22,40	18,00	4	63392		67376	
UNF 1"3/8	12		144	39	25,00	20,00	4	63446		67394	
UNF 1"1/2	12		149	39	28,00	22,40	4	64121		67403	



Ref. **3500**

COJINETE MANO MÉTRICA / MÉTRICA FINA

Metric / Metric Fine Hand Die

Filière à main métrique / métrique pas fin



HSS	DIN 223	Tol. 6g	α 10-17°	Chafilán Entrada 1,75h Chamfer 1,75 Threads Chanfrein 1,75 filets
------------	------------	------------	--------------------	---

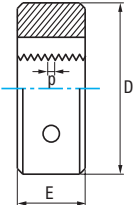

M/MF	P	D mm	E mm	Nº Art.	€
M2	0,40	16	5	63191	
M2,5	0,45	16	5	75001	
M3	0,50	20	5	63194	
M3,5	0,60	20	5	63197	
MF4	0,50	20	5	77025	
M4	0,70	20	5	63200	
M4,5	0,75	20	7	77028	
MF5	0,50	20	5	77029	
M5	0,80	20	7	63203	
MF6	0,50	20	5	77034	
MF6	0,75	20	7	77035	
M6	1,00	20	7	63206	
MF7	0,75	25	9	77037	
M7	1,00	25	9	63209	
MF8	0,50	25	9	77038	
MF8	0,75	25	9	77039	
MF8	1,00	25	9	63212	
M8	1,25	25	9	63215	
MF9	1,00	25	9	77041	
M9	1,25	25	9	63218	
MF10	0,75	30	11	77043	
MF10	1,00	30	11	63221	
MF10	1,25	30	11	63224	
M10	1,50	30	11	63227	
MF11	1,00	30	11	77045	
MF11	1,25	30	11	77046	
M11	1,50	30	11	63230	
MF12	1,00	38	10	63233	
MF12	1,25	38	10	63236	
MF12	1,50	38	10	63239	
M12	1,75	38	14	63242	
MF13	1,00	38	10	77049	
MF13	1,50	38	10	77050	
MF14	1,00	38	10	63251	
MF14	1,25	38	10	63254	
MF14	1,50	38	10	63257	
M14	2,00	38	14	63260	
MF15	1,00	38	10	75307	
MF15	1,50	38	10	77053	
MF16	1,00	45	14	63266	
MF16	1,25	45	14	77054	
MF16	1,50	45	14	63269	
M16	2,00	45	18	63272	
MF18	1,00	45	14	77057	
MF18	1,25	45	14	77058	
MF18	1,50	45	14	63278	
MF18	2,00	45	14	63281	
M18	2,50	45	18	63284	
MF20	1,00	45	14	77061	
MF20	1,50	45	14	63287	
MF20	2,00	45	14	63290	

M/MF	P	D mm	E mm	Nº Art.	€
M20	2,50	45	18	63293	
MF22	1,00	55	16	77066	
MF22	1,50	55	16	63296	
MF22	2,00	55	16	63299	
M22	2,50	55	22	63302	
MF24	1,00	55	16	77069	
MF24	1,50	55	16	77070	
MF24	2,00	55	16	63308	
M24	3,00	55	22	63311	
MF25	1,00	55	16	77072	
MF25	1,50	55	16	77073	
MF26	1,00	55	16	77075	
MF26	1,50	55	16	77076	
MF27	1,00	65	18	70103	
MF27	1,50	65	18	77656	
MF27	2,00	65	18	77079	
M27	3,00	65	25	63314	
MF28	1,50	65	18	77081	
MF30	1,00	65	18	77082	
MF30	1,50	65	18	77083	
MF30	2,00	65	18	75310	
M30	3,50	65	25	63317	
MF32	1,50	65	18	77085	
MF33	1,50	65	18	77088	
MF33	2,00	65	18	77089	
M33	3,50	65	25	77090	
MF35	1,50	65	18	77093	
MF36	1,50	65	18	75311	
MF36	2,00	65	18	77095	
MF36	3,00	65	25	77096	
M36	4,00	65	25	77097	
New! MF39	1,50	75	20	84227	
New! MF39	2,00	75	20	84228	
New! MF39	3,00	75	30	84229	
M39	4,00	75	30	77103	
MF40	1,50	75	20	77104	
MF40	2,00	75	20	77105	
MF40	3,00	75	30	70104	
MF42	2,00	75	20	77108	
MF42	3,00	75	30	70106	
M42	4,50	75	30	77110	
MF45	1,50	90	22	77112	
MF45	2,00	90	22	77113	
MF45	3,00	90	36	77114	
M45	4,50	90	36	77115	
MF48	1,50	90	22	70107	
MF48	3,00	90	36	35159	
M48	5,00	90	36	77119	
MF50	1,50	90	22	77120	
MF52	1,50	90	22	77121	
M52	5,00	90	36	77124	



Set - Ref. 3500



7 Pcs

Cont. Ø	Nº Art.	€
Cojinetes / Dies / Filières DIN 223: M3-M4-M5-M6- M8-M10-M12	56518	

Línea 33 cm - Ref. 3500



20
cm

Ø	M4	M5	M6	M8	M10	M12
Pcs	2	2	2	2	2	2

Ref. 4995 - Nº Art. 71001: €



Ref. **3005**

TERRAJA MONOBLOCK METAL

METAL Monoblock Die
Filière monoblock MÉTAL

DISEÑO
EXCLUSIVO!
IZAR
CUTTING TOOLS



HSS	DIN 223		Tol. 6g	α 10-17°	Con Guía Guided Avec Guide
------------	---------	--	---------	-----------------	-----------------------------------

M	P	D mm	Nº Art.	€
M3	0,50	20	25226	
M4	0,70	20	25227	
M5	0,80	20	25228	
M6	1,00	20	25229	
M8	1,25	25	25231	
M10	1,50	30	25233	
M12	1,75	38	25581	



Display 43 - Ref. 3005



Ref. 3005	Ø	M-4	M-5	M-6	M-8	M-10	M-12
Pcs		2	2	2	2	2	2

Ref. 4995 - Nº Art. 32964: €

Ref. **3006**

JUEGO TERRAJAS MONOBLOCK Y MACHOS MANO

Monoblock Die & Hand Tap Set
Jeu filières monoblock & tarauds à main

30 Pcs

Cont.	Nº Art.	€
Juegos Machos Tap Sets / Jeux Tarauds M3 - M4 - M5- M6 - M8 - M10 - M12	78141	
Terrajas / Dies / Filières Monoblock Ref. 3005 M3 - M4 - M5- M6 - M8 - M10 - M12		
Gira-Machos Tap-Wrench / Porte-Tarauds M1 - M12		
Galga Gauge / Gabarit 1 pc		



Ref. **3536**

COJINETE MANO MÉTRICA / MÉTRICA FINA INOX

Stainless Metric / Metric Fine Hand Die
Filière à main métrique / métrique pas fin inox



HSSE 5% Co	DIN 22568		Tol. 6g	α 20°	Vaporizado Vaporized Vaporisée
----------------------	--------------	--	------------	-----------------	---

Aceros Steels Aciers	INOX Stainless Steel Acier INOX	Chaflán Entrada 2,25h Chamfer 2,25 Threads Chanfrein 2,25 filets
-----------------------------------	--	---

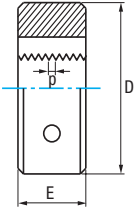

M	P	D mm	E mm	N° Art.	€
M3	0,50	20	5	34255	
M4	0,70	20	5	34256	
M5	0,80	20	7	34257	
M6	1,00	20	7	34258	
M7	1,00	25	9	55515	
M8	1,25	25	9	34259	
MF10	0,75	30	11	81370	
MF10	1,00	30	11	81371	
MF10	1,25	30	11	81372	
M10	1,50	30	11	34260	
MF12	1,00	38	10	81373	
MF12	1,25	38	10	81374	
MF12	1,50	38	10	81375	
M12	1,75	38	14	34261	
MF14	1,00	38	10	81376	
MF14	1,50	38	10	81377	
M14	2,00	38	14	34262	
MF15	1,00	38	10	81378	
MF16	1,00	45	14	81379	

M	P	D mm	E mm	N° Art.	€
MF16	1,50	45	14	81380	
M16	2,00	45	18	34263	
MF17	1,00	45	14	81381	
MF18	1,00	45	14	81382	
MF18	1,50	45	14	81383	
MF18	2,00	45	14	81384	
M18	2,50	45	18	34264	
MF20	1,00	45	14	81385	
MF20	1,50	45	14	81386	
MF20	2,00	45	14	81387	
M20	2,50	45	18	34265	
MF22	1,00	55	16	81388	
MF22	1,50	55	16	81389	
MF22	2,00	55	16	81390	
M22	2,50	55	22	81391	
MF24	1,50	55	16	81392	
M24	3,00	55	22	81393	
M27	3,00	65	25	81394	
M30	3,50	65	25	81395	
M33	3,50	65	25	83117	



Set 7 Pcs

Cont.	N° Art.	€
Cojinetes / Dies / Filières DIN 223: M3-M4-M5-M6-M8-M10-M12	76494	

Línea 33 cm - Ref. 3536



∅	M4	M5	M6	M8	M10	M12
Pcs	2	2	2	2	2	2

Ref. 4995 - N° Art. 71005: €



Ref. **3510**

COJINETE MANO MÉTRICA ISO

ISO Metric Hand Die
Filière à main métrique ISO



HSS

ISO
529

Tol.
6g

α
10-17°

Forma
A
Form

Ajustable
BS 1127 A
Adjustable

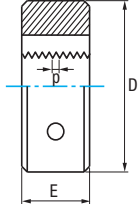

M	P	D mm	E mm	N° Art.	€
M3	0,50	25,4	9,5	38230	
M4	0,70	25,4	9,5	38231	
M5	0,80	25,4	9,5	38232	
M6	1,00	25,4	9,5	38233	
M7	1,00	25,4	9,5	38234	
M8	1,25	25,4	9,5	38235	
M10	1,50	25,4	9,5	38237	
M12	1,75	25,4	9,5	38238	

M	P	D mm	E mm	N° Art.	€
M8	1,25	38,1	12,7	38239	
M10	1,50	38,1	12,7	38240	
M12	1,75	38,1	12,7	38242	
M14	2,00	38,1	12,7	38243	
M16	2,00	38,1	12,7	38244	
M18	2,50	38,1	12,7	38245	
M20	2,50	38,1	12,7	38246	



M	P	D mm	E mm	N° Art.	€
M18	2,50	50,8	15,9	38250	
M20	2,50	50,8	15,9	38251	
M22	2,50	50,8	15,9	38252	
M24	3,00	50,8	15,9	38253	

Línea 33 cm - Ref. 3510

16
cm



∅	M4×25,4	M5×25,4	M6×25,4	M8×25,4	M10×25,4	M12×25,4
Pcs	2	2	2	2	2	2

Ref. 4995 - N° Art. 72129: €



COJINETES HEXAGONALES

Hexagon Die Nuts
Filières hexagonales

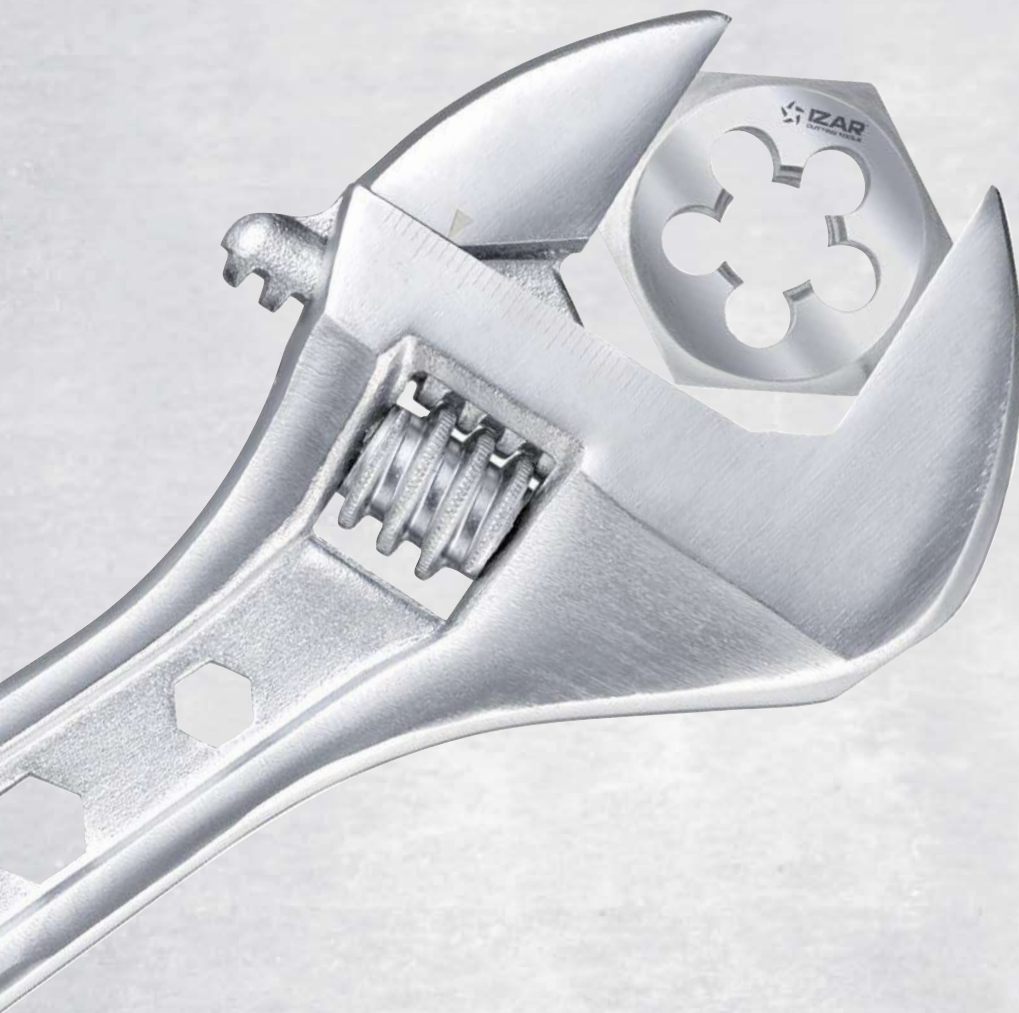

Los cojinetes hexagonales se utilizan para trabajos de montaje y repasado de roscas con resistencia a la tracción baja y media. Las medidas clave estandarizadas del hexágono permiten el uso de llaves ajustables y llaves fijas como herramientas de trabajo.

Hexagon Die Nuts are used for assembly works and re-cutting of threads with low and medium tensile strength. The standardized key metrics of the hexagon enable the usage of ring wrenches and open-end wrenches as operating tools.

Les filières hexagonales sont utilisées pour les travaux hors atelier et pour retoucher des filetages avec une résistance à la traction faible/moyenne. Les mesures entre les faces de l'hexagone permettent l'utilisation de clés réglables et de clés fixes standard comme outils de serrage.

Ref. **3560**

COJINETE MANO HEXAGONAL MÉTRICA / MÉTRICA FINA

Metric / Metric Fine HEX Hand Die

Filière à main hexagonale métrique / métrique pas fin

New!

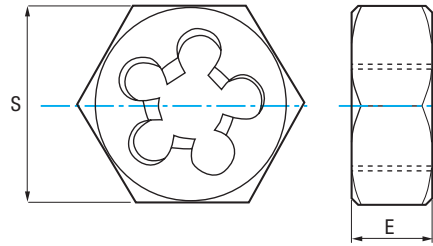

HSS	DIN 382		Tol. 6g
-----	---------	--	---------

M/MF	P	S mm	E mm	N° Art.	€
MF3	0,35	19	5	84244	
M3	0,50	19	5	84245	
M3,5	0,60	19	5	84246	
MF4	0,50	19	5	84247	
M4	0,70	19	5	84248	
M4,5	0,75	19	7	84249	
MF5	0,50	19	7	84250	
M5	0,80	19	7	84251	
MF6	0,75	19	7	84252	
M6	1,00	19	7	84253	
MF7	0,75	22	9	84254	
M7	1,00	22	9	84255	
MF8	0,75	22	9	84256	
MF8	1,00	22	9	84259	
M8	1,25	22	9	84260	
MF9	1,00	22	9	84261	
M9	1,25	22	9	84262	
MF10	1,00	27	11	84263	
M10	1,50	27	11	84264	
MF11	1,00	27	11	84266	
M11	1,50	27	11	84267	
MF12	1,00	36	10	84268	
MF12	1,25	36	10	84269	
MF12	1,50	36	10	84270	
M12	1,75	36	14	84271	
MF14	1,00	36	10	84272	
MF14	1,25	36	10	84273	
MF14	1,50	36	10	84274	
M14	2,00	36	14	84275	
MF16	1,50	41	14	84276	

M/MF	P	S mm	E mm	N° Art.	€
M16	2,00	41	18	84277	
MF18	1,50	41	14	84278	
MF18	2,00	41	14	84279	
M18	2,50	41	18	84281	
MF20	1,50	41	14	84283	
MF20	2,00	41	14	84282	
M20	2,50	41	18	84284	
MF22	1,50	50	16	84285	
MF22	2,00	50	16	84286	
M22	2,50	50	16	84287	
MF24	1,50	50	16	84288	
MF24	2,00	50	16	84289	
M24	3,00	50	22	84290	
MF26	1,50	60	18	84291	
MF27	1,50	60	18	84292	
MF27	2,00	60	18	84293	
M27	3,00	60	25	84294	
MF28	1,50	60	18	84295	
MF30	1,50	60	18	84296	
MF30	2,00	60	18	84297	
M30	3,50	60	25	84298	
MF32	1,50	60	18	84299	
MF33	1,50	60	18	84300	
MF33	2,00	60	18	84301	
M33	3,50	60	25	84302	
MF35	1,50	60	18	84303	
MF36	1,50	60	18	84304	
MF36	2,00	60	18	84305	
MF36	3,00	60	18	84306	
M36	4,00	60	25	84307	



- | | | |
|--|---|---|
| <ul style="list-style-type: none"> • Para uso con llave fija, ajustable o de vaso • Ideal para espacios limitados • Recomendado para reparar roscas | <ul style="list-style-type: none"> • For use with a fixed, extendable, or socket wrench • Ideal for tight spaces • Recommended for rethreading threads | <ul style="list-style-type: none"> • Pour une utilisation avec une clé fixe, une clé extensible ou à douille • Idéal pour les espaces restreints • Recommandé pour réparer les filetages |
|--|---|---|



Ref. **3502**

COJINETE MANO WHITWORTH

Whitworth Hand Die
Filière à main Whitworth



HSS	DIN 223	α 10-17°	Chaflán Entrada 1,75h Chamfer 1,75 Threads Chanfrein 1,75 Filets
------------	---------	-----------------	---

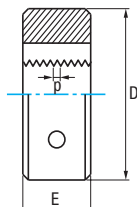

W	Hilos Threads Filets	D mm	E mm	Nº Art.	€	W	Hilos Threads Filets	D mm	E mm	Nº Art.	€
W3/32	48	16	5	63344		W7/16	14	30	11	63362	
W1/8	40	20	5	63329		W1/2	12	38	14	63320	
W5/32	32	20	7	63356		W9/16	12	38	14	63368	
W3/16	24	20	7	63341		W5/8	11	45	18	63347	
W7/32	24	20	7	63365		W3/4	10	45	18	63332	
W1/4	20	20	7	63323		W7/8	9	55	22	63359	
W5/16	18	25	9	63350		W1"	8	55	22	63374	
W3/8	16	30	11	63335		W1" 1/8	7	65	25	63383	

Ref. **3546**

COJINETE MANO BSP (GAS) INOX

Stainless BSP (Gas) Hand Die
Filière à main BSP (Gaz) Inox



HSSE 5% Co	DIN 24231		Tol. A	α 20°	Chaflán Entrada 2,25h Chamfer 2,25 Threads Chanfrein 2,25 filets
-------------------	-----------	--	--------	--------------	---

	Rosca británica para tubo paralelo (BSPP-GAS) British Standard Parallel Pipe (BSPP-GAS) Filetage britannique pour tuyau parallèle (BSPP-GAS)	Vaporizado Vaporized Vaporisée
--	---	---

Aceros Steels Aciers	INOX Stainless Steel Acier INOX
---	--

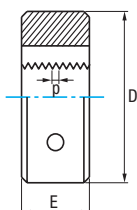

G	Hilos Threads Filets	D mm	E mm	Nº Art.	€
G1/8	28	30	11	81341	
G1/4	19	38	10	81342	
G3/8	19	45	14	81343	
G1/2	14	45	14	81344	
G3/4	14	55	16	81345	
G1"	11	65	18	81346	



Ref. **3506**

COJINETE MANO BSP (GAS)

BSP (Gas) Hand Die
Filière à main BSP (Gaz)



HSS	DIN 24231	α 10-17°	Chaflán Entrada 1,75h Chamfer 1,75 Threads Chanfrein 1,75 filets	Vaporizado Vaporized Vaporisée
------------	--------------	--------------------	---	---

 **Rosca británica para tubo paralelo (BSPP-GAS)**
British Standard **Parallel** Pipe (BSPP-GAS)
Filetage britannique pour tuyau **parallèle** (BSPP-GAS)

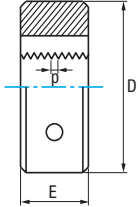

G	Hilos Threads Filets	D mm	E mm	Nº Art.	€
G1/8	28	30	11	63461	
G1/4	19	38	10	63455	
G3/8	19	45	14	63467	
G1/2	14	45	14	63452	
G5/8	14	55	16	75496	
G3/4	14	55	16	63464	
G7/8	14	65	18	76252	
G1"	11	65	18	63470	
G1" 1/8	11	75	20	76202	
G1" 1/4	11	75	20	76210	
G1" 1/2	11	90	22	76224	
New! G1" 3/4	11	105	22	76230	
New! G2"	11	105	22	76236	



Ref. **3191**

GIRA-MACHOS

Tap Wrench
Porte-taroud



DIN
1814



Mod.	Uso Use Usage	L mm	Cuadradillo Square / Carré mm	Nº Art.	€
000	M1-M8	130	1,50-7,00	69826	
010	M1-M10	175	2,00-8,60	69828	
015	M1-M12	175	2,00-8,60	69829	
020	M4-M12	280	3,00-11,50	69831	
030	M5-M20	375	4,50-14,50	69832	

Mod.	Uso Use Usage	L mm	Cuadradillo Square / Carré mm	Nº Art.	€
040	M9-M27	470	4,50-18,00	69834	
050	M13-M32	740	5,30-22,30	69835	
* 060	M20-M40	880	6,60-27,00	83111	
* 070	M25-M50	985	14,50-39,00	26694	
New! * 080	M25-M70	1190	16,00-42,50	24537	

* Acero / Steel / Acier

Línea 33 cm - Ref. 3191



34
cm

Mod.	000	010	015	020	030
Pcs	2	2	2	2	2

Ref. 4995 - Nº Art. 80556: €

Ref. **3912**

GIRA-MACHOS CRIQUÉ

Tap Wrench
Porte-taroud



"T" +
Criqué



Mod.	M	L mm	Cap. mm	Nº Art.	€
01	M3-M10	85	2,4-5,5	25340	
02	M5-M12	100	4,5-8,0	25341	
10	M3-M10	250	2,4-5,5	25342	
20	M5-M12	300	4,5-8,0	25343	

Línea 33 cm - Ref. 3912



38
cm

Mod.	01	02	10	20
Pcs	2	2	2	2

Ref. 4995 - Nº Art. 72135: €



Ref. **3181**

PORTA-COJINETES

Die Holder
Porte filières

¡NUEVO MODELO MEJORADO!
New improved model!
Nouveau modèle amélioré !



DIN
225

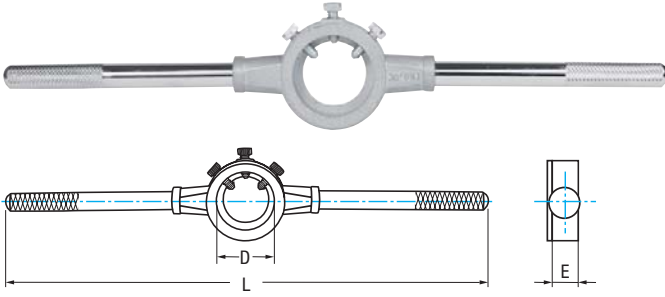

Mod.	D mm	E mm	L mm	M/MF	W	G	N° Art.	€
000	16	5	160	M1-M2,6	W1/16-W3/32		69792	
010	20	5	180	M3-M4	W1/8-W5/32		69790	
020	20	7	195	M4,5-M6	W3/16-W1/4		69798	
030	25	9	215	M7-M9	W5/16	G1/16	69799	
040	30	11	260	M10-M11	W3/8-W7/16	G1/8	69811	
050	38	14	313	M12-M15	W1/2-W9/16		69813	
060	38	10	313	MF12-MF15		G1/4	69814	
070	45	18	445	M16-M20	W5/8-W3/4		69816	
080	45	14	445	MF16-MF20		G3/8-G1/2	69817	
090	55	22	495	M22-M24	W7/8-W1		69819	
100	55	16	495	MF21-MF26		G5/8-G3/4	69795	
110	65	25	555	M27-M36	W1 1/8 - W1 3/8		69796	
120	65	18	555	MF27-MF36		G7/8-G1	30484	
* 130	75	30	540	M39-M42	W1 1/2 - W1 5/8		32600	
* 140	75	20	540	MF38-MF42		G1 1/8 - G1 1/4	43515	
* 150	90	36	800	M45-M52	W1 3/4 - W2		43516	
* 160	90	22	800	MF45-MF52		G1 1/2	43517	

* Acero / Steel / Acier



Ref. **3184**

PORTA-COJINETES ISO 529

ISO 529 Die Holder
Porte filières ISO 529

DIN
225

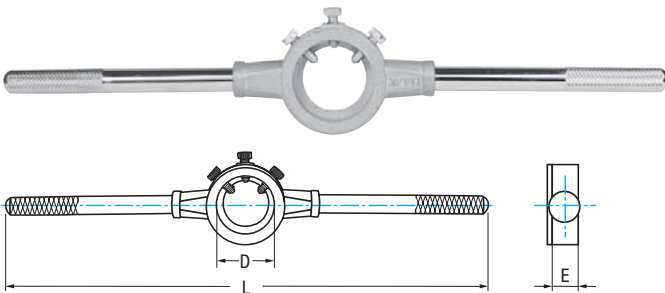

D mm	E mm	L mm	M	W	N° Art.	€
25,50	13,10	210	M3-M12	W1/8-W1/2	43317	
38,50	17,30	320	M8-M20	W5/16-W3/4	43318	
51,20	21,10	385	M18-M24	W11/16-W1	43319	



Ref. **3900**

GALGA

Pitch Gauge
Jauge



Cap. M	Cap. W	N° Art.	€
0,25-6,00	4G-62G	44612	
0,40-6,00		67641	



Ref. **3405**

JUEGO MACHOS MANO MÉTRICA

Metric Hand Tap Set
Jeu de tarauds à main métrique

Set 29 Pcs

Cont.	Nº Art.	€
Juegos Machos / Tap Sets / Jeux Tarauds M3-M4-M5-M6-M8-M10-M12		
Brocas / Drill Bits / Forets mm 2,5-3,3-4,2-5,0-6,8-8,5-10,2	69624	
Gira-Machos / Tap-Wrench / Porte-Tarauds M1-M12		



Ref. **3404**

JUEGO MACHOS MANO PERFIL ROSCA COMPLETA

Whole Thread Profile Hand Tap Set
Jeu de tarauds à main profil filetage complet

Set 15 Pcs

Cont.	Nº Art.	€
Machos / Taps / Tarauds M3-M4-M5-M6-M8-M10-M12		
Brocas / Drill Bits / Forets mm 2,5-3,3-4,2-5,0-6,8-8,5-10,2	68214	
Gira-Machos / Tap-Wrench / Porte-Tarauds M1-M12		



Ref. **3406**

JUEGO MACHOS Y COJINETES MANO MÉTRICA

Metric Hand Tap & Die Set
Jeu de tarauds et filières à main métrique



New! ISO

33 Pcs

Mod. 0 - Cont.

Juegos Machos Tap Sets / Jeux Tarauds	M3-M4-M5-M6-M8-M10-M12
Gira-Machos Tap-Wrench / Porte-Tarauds	M1-M12
Gira-Machos Tap-Wrench / Porte-Tarauds	Criqué M3-M10 Ratchet
Cojinetes Dies / Filières	M3-M4-M5-M6-M8-M10-M12
Porta-Cojinetes Die Holder / Porte-Filières	25x9
Galga Gauge / Gabarit	1 pc
Destornillador Screwdriver / Tournevis	1 pc



N° Art.	€
70527	



N° Art.	€
18959	

55 Pcs

Mod. 1 - Cont.

	N° Art.	€
Juegos Machos Tap Sets / Jeux Tarauds	M3-M4-M5-M6-M8-M10-M12-M14-M16-M18-M20	
Gira-Machos Tap-Wrench / Porte-Tarauds	M1-M12, M5-M20	
Gira-Machos Tap-Wrench / Porte-Tarauds	Criqué M3-M10 + M5-M12 Ratchet	
Cojinetes Dies / Filières	M3-M4-M5-M6-M8-M10-M12-M14-M16-M18-M20	38404
Porta-Cojinetes Die Holder / Porte-Filières	20x5, 20x7, 25x9, 30x11, 38x14, 45x18	
Galga Gauge / Gabarit	1 pc	
Destornillador Screwdriver / Tournevis	1 pc	



45 Pcs

Mod. 2 - Cont.

	N° Art.	€
Juegos Machos Tap Sets / Jeux Tarauds	M3-M4-M5-M6-M8-M10-M12	
Gira-Machos Tap-Wrench / Porte-Tarauds	M1-M10, M4-M12	
Gira-Machos Tap-Wrench / Porte-Tarauds	Criqué M3-M10 Ratchet	
Cojinetes Dies / Filières	M3-M4-M5-M6-M8-M10-M12	38981
Porta-Cojinetes Die Holder / Porte-Filières	20x5, 20x7, 25x9, 30x11, 38x14	
Galga Gauge / Gabarit	1 pc	
Destornillador Screwdriver / Tournevis	1 pc	
Brocas Drill Bits / Forets mm	2,5-3,3-4,2-5,0-6,8-8,5-10,2	



Ref. **9016**

BROCA METAL DURO DESTRUCTORA MACHOS

Tap Destroyer Solid Carbide Drill Bit
Foret carbure destructeur de tarauds

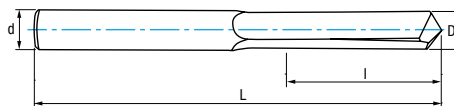

MD / HM Carbure Grano UF	IZAR Std.	120°		Tol. h6
--------------------------------	--------------	------	--	------------

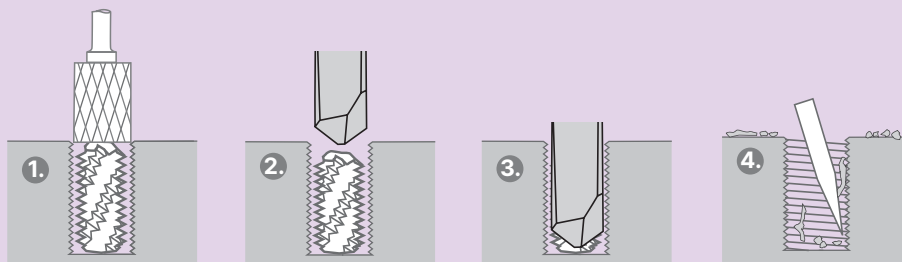

PROCEDIMIENTO PARA QUITAR MACHOS ROTOS:

1. Macho roto

Si sobresale alguna parte del macho roto, alisarla para poder taladrarlo más fácilmente.

2. Centrado de la broca

Colocar la broca sobre el centro del macho, fijando bien tanto la pieza de trabajo como la misma broca.

Sin lubricante, hacer un taladrado inicial de aproximación y retraer la broca rápidamente.

3. Proceso de taladrado

Taladrar a velocidad y avance fijos, y con parones para evacuar la viruta. Utilizar lubricación.

4. Sustraer el macho roto

Sustraer los restos del macho roto con un buril o instrumento similar.

PROCEDURE FOR REMOVING BROKEN TAPS:

1. Broken Tap

If any part of the broken tap is protruding, grind the surface in order to make it flat.

2. Centering of the Drill

Position the drill bit on the center of the broken tap. Please make sure that both the workpiece and the tap are firmly secured. Make an initial drill approach and retract the drill bit quickly. Don't use any lubrication.

3. Drilling

Drill the hole at a fixed speed and feed, stopping the process occasionally to remove the broken chips. Use lubrication in this step.

4. Chip Removal

The parts of the broken tap can be removed using a scriber or a similar tool.

PROCÉDURE POUR ENLEVER LES TARAUDS CASSÉS :

1. Taraud cassé

Si une partie du taraud dépasse, lissez la surface endommagée du taraud au ras de la pièce pour la percer plus facilement.

2. Centrage du foret

Placez le foret au centre du taraud. Assurez-vous que la pièce et le foret sont correctement centrés. Faites un premier perçage d'approximation, puis rétractez rapidement le foret. Pour cette étape, n'utilisez pas de lubrifiant.

3. Processus de perçage

Percez le trou à vitesse et avance fixes, en arrêtant de temps en temps pour évacuer les copeaux. Utilisez du lubrifiant.

4. Retirer les restes

Les restes peuvent être retirés en utilisant un buril ou similaire

- Diseño especial para retirar machos rotos.
- Requiere una buena sujeción de pieza y cabezal rígido.
- No válido para extraer machos de laminación.
- Specifically designed for removing broken taps.
- It is recommended to use a proper fixing with an stable chuck.
- Not suitable for forming taps.
- Conception spéciale pour enlever les tarauds cassés.
- Nécessite un bon serrage de la pièce et une tête rigide.
- Non valide pour retirer les tarauds réfileurs.

D mm	d mm	L mm	l mm	Macho * Tap - Taraud		Nº Art. MD/HM	€
2,00	3,00	38	10	M3	1	58951	
3,00	3,00	38	15	M4 - M5	1	58954	
4,00	4,00	50	20	M6	1	59987	
5,00	5,00	50	25	M8 - M10	1	59989	
6,00	6,00	60	30	M12	1	66145	
7,00	8,00	79	35	M14	1	66399	
8,00	8,00	79	40	M16	1	66407	
9,00	10,00	100	45	M18	1	66408	
10,00	10,00	100	50	M20	1	66409	

* El \varnothing de la broca deberá ser superior al \varnothing núcleo del macho.
The \varnothing of the drill bit must be greater than the \varnothing of the tap core.
Le \varnothing du foret doit être supérieur au \varnothing du noyau du taraud.



Set 5 Pcs

Cont.	Nº Art.	€
2-3-4-5-6 mm	83426	



Ref. **3409**

EXTRACTOR TORNILLOS

Screw Extractor
Extracteur vis



Mod.	P/ Tornillo F/ Screw P/ Vis	P/ Tornillo F/ Screw P/Vis	D mm	a mm	Nº Art.	€
010	M3-M6	1/8-1/4	2,50	2,70	40639	
020	M6-M8	1/4-5/16	3,00	3,80	40641	
030	M8-M11	5/16-7/16	4,50	4,90	40642	
040	M11-M14	7/16-9/16	6,00	7,00	40644	
050	M15-M18	9/16-3/4	8,00	9,00	40645	
060	M18-M24	3/4-1	11,00	12,00	40647	



Set 5 Pcs

Set P/ Tornillo F/ Screw P/ Vis	P/ Tornillo F/ Screw P/ Vis	Nº Art.	€
M3-M18	1/8-3/4	75905	

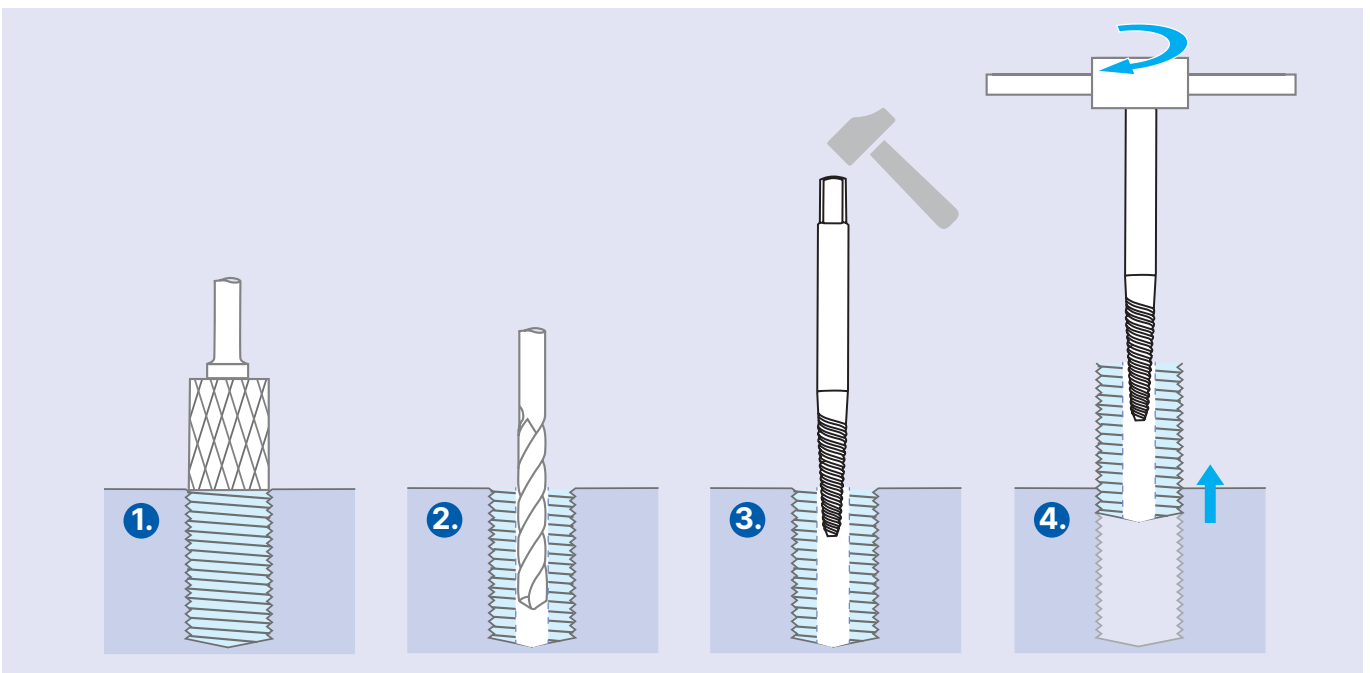

INSTRUCCIONES USO:

1. Alisar la superficie del tornillo con rotativa Ref. 9260.
2. Taladrar un agujero centrado con broca apropiada. Recomendamos Ref. 1016.
3. Introducir el extractor asegurándose de que quede fijo.
4. Girar el extractor hacia la izquierda hasta extraer el tornillo.

DIRECTIONS FOR USE:

1. Grind the Surface of the screw head with Rotary Burr Ref. 9260.
2. Drill a hole on the screw using a suitable drill bit. We recommend our Ref. 1016.
3. Introduce the extractor and make sure it gets fixed/locked.
4. Turn left the extractor until the screw gets out.

INSTRUCTIONS D'EMPLOI:

1. Lissez la surface de la vis avec une fraise lime rotative Réf. 9260.
2. Percez un trou centré avec un foret approprié. Nous recommandons notre Réf. 1016.
3. Insérez l'extracteur et assurez-vous qu'il est fixé.
4. Tournez à gauche l'extracteur jusqu'à retirer la vis.

Línea 33 cm - Ref. 3409

19 cm



Mod.	10	20	30	40	50	60
Pcs	5	5	5	5	5	4

Ref. 4995 - Nº Art. 72139: €





ACEITES DE CORTE Y REFRIGERANTES

Cutting Oils & Water Soluble Fluids

Huiles de coupe et lubrifiants

ACEITES DE CORTE

Aceite de corte de uso general de alta gama, formulado a base de aceites vegetales y libre de cloruros. Para aplicaciones de corte en general (taladrado, roscado, fresado, torneado, etc.)

Cutting Oils

High-end general purpose cutting oil, formulated from vegetable oils and chloride-free. For general cutting applications (drilling, threading, milling, turning, etc.)

Huiles de coupe

Huile de coupe à usage général haut de gamme, formulée à base d'huiles végétales et sans chlorures. Pour des applications de coupe en général (perçage, taraudage, fraisage, tournage, etc.).

REFRIGERANTES - TALADRINA

Aceite emulsionable altamente concentrado libre de cloruros, aminas secundarias y / o nitritos

Water Soluble Fluids

Highly concentrated emulsifiable oil free of chlorides, secondary amines and/or nitrites

Lubrifiants

Huile émulsifiable hautement concentrée, exempte de chlorures, d'amines secondaires et/ou de nitrites



ACEITES DE CORTE

Cutting Oils - Huiles de coupe

UNI
Universal

New!

Viscosidad a 40°C Viscosity / Viscosité: 37 cSt	No Soluble
---	---------------

- * Disponible Ficha Técnica
- * Data Sheet available
- * Fiche technique disponible

APLICACIÓN:

Para aplicaciones de uso general y universal (UNI) en todos los metales ferrosos.

APPLICATION:

For general purpose and universal (UNI) applications on all ferrous metals.

APPLICATION:

Pour des applications à usage général et universel (UNI) sur tous les métaux ferreux.



Cont. 250 ml
Nº Art. 53898
€

Cont. 500 ml
Nº Art. 53901
€

Cont. 1L
Nº Art. 53903
€

Cont. 5L
Nº Art. 53904
€

Cont. 10L
Nº Art. 53906
€

Cont. 25L
Nº Art. 53907
€

INOX
Heavy Duty

New!

VISCOSIDAD EXTRA !
Extra Viscosity!
Viscosité supplémentaire !

Viscosidad a 40°C Viscosity / Viscosité: 173 cSt	No Soluble
--	---------------

- * Disponible Ficha Técnica
- * Data Sheet available
- * Fiche technique disponible

APLICACIÓN:

Para aplicaciones de mecanizado pesado (Heavy Duty) en todos los metales ferrosos y para un rendimiento mejorado en aceros inoxidables (INOX).

APPLICATION:

For heavy duty machining applications on all ferrous metals and for improved performance on stainless steels (STAINLESS).

APPLICATION:

Pour des applications d'usinage lourd (Heavy Duty) sur tous les métaux ferreux et pour améliorer les performances sur les aciers inoxydables (INOX).



Cont. 250 ml
Nº Art. 53928
€

Cont. 500 ml
Nº Art. 53934
€

Cont. 1L
Nº Art. 53936
€

Cont. 5L
Nº Art. 53937
€

Cont. 10L
Nº Art. 53940
€

Cont. 25L
Nº Art. 53942
€



Non Ferrous

Viscosidad a 40°C Viscosity / Viscosité: 4,20 cSt	No Soluble
---	---------------

- * Disponible Ficha Técnica
- * Data Sheet available
- * Fiche technique disponible

APLICACIÓN:

Especial para aplicaciones en todos los metales no ferrosos como aluminio (ALU), cobre, latón, bronce, zinc

APPLICATION:

Specially for applications on all non-ferrous metals such as aluminium (ALU), copper, brass, bronze, zinc, etc.

APPLICATION:

Spécialement indiqué pour les applications sur tous les métaux non ferreux, tels que l'aluminium (ALU), le cuivre, le laiton, le bronze, le zinc, etc.



Cont. 250 ml
Nº Art. 53943
€



Cont. 500 ml
Nº Art. 53946
€



Cont. 1L
Nº Art. 53948
€



Cont. 5L
Nº Art. 53949
€



Cont. 25L
Nº Art. 79042
€

New! DISPLAYS

9x250ml
UNI

Nº Art.	€
13929	Set Price!

UNI
Universal

UNI+INOX+ALU
3+3+3x250ml
MIXTO

Nº Art.	€
13930	Set Price!

UNI **INOX** **ALU**
Universal Heavy Duty Non Ferrous

6x400ml
AEROSOL

Nº Art.	€
13912	Set Price!

UNI
Universal



New! AEROSOL - Aerosol - Aérosol

2 Cánulas / 2 Nozzles / 2 Canules



Chorro líquido
Liquid jet
Jet liquide



Cont. 400ml

Nº Art. 53900

€

Spray

Para aplicaciones de uso general en todos los metales ferrosos

For general purpose applications on all ferrous metals

Pour des applications à usage général sur tous les métaux ferreux



12 UNI

Nº Art.	€
53926	Box Price!

New! ESPUMA - Foam - Mousse



Fuerte adhesión sin goteos. Lavable con agua

Strong adherence without drips. Washable with water

Forte adhérence sans gouttes. Lavable à l'eau

Cont. 400ml

Nº Art. 48302

€



12 UNI

Nº Art.	€
48299	Box Price!

MULTI

Multiusos

New!

Multiusos - Multi-purpose - Multifonction

APLICACIÓN:

Mecanizado de aceros duros, inoxidables, aleaciones de cobre y toda clase de metales

Fuertemente aditivado para lubricar y proteger contra la corrosión

APPLICATION:

Machining of hard steels, stainless steels, copper alloys and all kinds of metals

Highly additivated for lubrication and corrosion protection

APPLICATION:

Usinage d'aciers durs, inoxydables, alliages de cuivre et tous types de métaux

Fortement additivé pour la lubrification et la protection contre la corrosion



Cont. 400ml

Nº Art. 84040

€



Pulveriza abiertamente con la cánula hacia abajo

Spray openly with the nozzle facing down

Vaporise ouvertement avec la canule vers le bas



Pulveriza con precisión con la cánula hacia arriba

Spray precisely with the nozzle facing up

Vaporise précisément avec la canule vers le haut



12 UNI

Nº Art.	€
84335	Box Price!



New! PASTA DE CORTE - Cutting Paste - Pâte de coupe

Pasta con propiedades lubricantes extremas. La pasta se asienta en las aristas de corte y se licua durante la operación de corte.

Ideal para todas las operaciones como roscado, taladrado y fresado de materiales difíciles de cortar como acero inoxidable, acero Cr-Ni, titanio, acero al manganeso, etc.

Paste with extreme lubricating properties. The paste settles on the cutting edges and liquefies during the cutting operation.

Ideal for all operations such as the threading, drilling and milling of difficult-to-cut materials such as stainless steel, Cr-Ni steel, titanium, manganese steel, etc.

Pâte aux propriétés lubrifiantes extrêmes. La pâte se dépose sur les bords de coupe et se liquéfie pendant l'opération de coupe.

Idéale pour toutes les opérations telles que le taraudage, le perçage et le fraisage de matériaux difficiles à couper comme l'acier inoxydable, l'acier Cr-Ni, le titane, l'acier au manganèse, etc.



Cont. 250ml

Nº Art. 53954

€



Cont. 750ml

Nº Art. 53956

€

Sumerja la herramienta de corte en la pasta para obtener resultados optimizados

Dip the cutting tool into the paste for optimised results

Trempez l'outil de coupe dans la pâte pour des résultats optimisés



New! CERA DE CORTE - Cutting Wax - Cire de coupe

Cera en barra de alta gama para refrigerante y lubricación de operaciones de corte en metales no ferrosos como aluminio, cobre, latón, etc. Libre de cloruros, sin humos o vapores nocivos.

Para todas las máquinas de hoja de sierra circular o sierra de cinta sin suministro de refrigerante. También apto para fresado, roscado, escariado, taladrado, torneado, etc.

High-end wax in a bar for the cooling and lubrication of cutting operations on non-ferrous metals such as aluminium, copper, brass, etc. Chloride free, no harmful fumes or vapours.

For all circular or band saw blade machines without coolant supply. Also suitable for milling, threading, reaming, drilling, turning, etc.

Cire en barre haut de gamme pour le refroidissement et la lubrification des opérations de coupe sur les métaux non ferreux tels que l'aluminium, le cuivre, le laiton, etc. Sans chlorures, sans fumées ni vapeurs nocives.

Pour toutes les machines à lame de scie circulaire ou à ruban sans alimentation en réfrigérant. Convient également pour le fraisage, taraudage, alésage, perçage, tournage, etc.



Cont. 300ml

Nº Art. 53957

€



Para aplicar la cera, sostenga brevemente la barra de cera contra la sierra giratoria. Repita cada 10-20 ciclos de aserrado

To apply the wax, briefly hold the wax bar against the rotary saw. Repeat every 10-20 sawing cycles

Pour appliquer la cire, maintenez brièvement la barre de cire contre la scie rotative. Répétez tous les 10 à 20 cycles de sciage

REFRIGERANTES - TALADRINA

Water Soluble Fluids - Lubrificants

STD

New!

Standard

Emulsión semisintética, transparente a semitransparente. Muy alta estabilidad ante los microorganismos. Apto para operaciones de rectificado. Concentración del 4-7% en función de la aplicación.

Semi-synthetic emulsion, transparent to semi-transparent. Very high stability to micro-organisms. Suitable for grinding operations. Concentration 4-7% depending on the application.

Émulsion semi-synthétique, transparente à semi-transparente. Très grande stabilité face aux microorganismes. Convient pour les opérations de meulage. Concentration de 4-7 % selon l'application.



 **Índice Refractómetro**
Refractometer Index
1,60 Indice de réfractomètre

- * Disponible Ficha Técnica
- * Data Sheet available
- * Fiche technique disponible

STANDARD

Cont.	5L
Nº Art.	53958
€	

TOP

New!

Top Line

Emulsión de color blanco lechoso. Para aplicaciones de alto rendimiento en aceros, materiales no ferrosos y aluminio. Concentración 6-10% en función de la aplicación.

Milky white emulsion. For high performance applications on steels, non-ferrous materials and aluminium. Concentration 6-10% depending on application.

Émulsion blanche laiteuse. Pour des applications de haute performance sur les aciers, les matériaux non ferreux et l'aluminium. Concentration de 6-10 % selon l'application.



 **Índice Refractómetro**
Refractometer Index
1,20 Indice de réfractomètre

- * Disponible Ficha Técnica
- * Data Sheet available
- * Fiche technique disponible

TOP LINE

Cont.	5L
Nº Art.	53959
€	



REPARADORES ROSCAS

Thread Repairs

Filets rapportés

Descripción

Desgaste, corrosión, excesiva torsión al ajustar el tornillo... son algunas de las causas que llevan a dañar una rosca sin posibilidad de reparación.

La gama de reparadores de roscas IZARCOIL permite reparar dichas roscas dañadas de manera rápida y económica. Unos reparadores de acero de gran calidad, para crear una rosca resistente a la temperatura y la corrosión.

Ventajas

- Instalación rápida y sencilla
- Resistente al desgaste y a la tensión
- Resistente a la corrosión y termoestable

Ejemplos de aplicaciones

- Refuerzo para roscar materiales con una reducida resistencia (p.e. aleaciones de aluminio y aleaciones de magnesio)
- Ingeniería mecánica
- Ingeniería de automoción y electricidad

Description

Wear, corrosion or excessive screw tightening torque... are some of the reasons that lead to threads getting damaged beyond repair.

IZARCOIL thread repair range enables worn and damaged threads to be repaired quickly and at low cost. In high-quality steel for a good thread, resistant to temperature and corrosion.

Advantages

- Fast and easy to install
- Stress resistant and wear-free
- Corrosion resistant and thermostable

Examples of Applications

- Thread reinforcement for materials with low shearing strength (e.g. aluminium or magnesium alloys)
- Mechanical engineering
- Automotive and electrical engineering

Description

Usure et trop de pression dans la fixation de la vis son des raisons pour endommager un filetage sans possibilité de réparation.

La gamme de filets rapportés IZARCOIL vous permet de réparer les filets endommagés rapidement et d'une façon économique.

Filets rapportés en aciers haute qualité pour avoir un filetage résistant à la température et à l'usure.

Avantages

- Installation rapide et simple
- Résistant à l'usure et a la tension
- Résistant aux variations de température

Exemples d'applications

- Soutien pour fileter aciers avec faible resistances (alliage aluminium et magnesium).
- Ingénierie mécanique
- Ingénierie auto et électricité

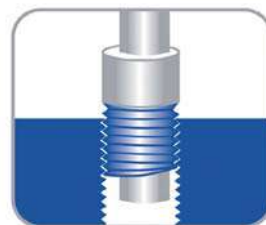

Uso

- 1- Taladrar la rosca dañada con una broca
- 2- Roscar con un macho IZARCOIL
- 3- Biselar el diámetro exterior a 90° y retirar la rebaba
- 4- Insertar el reparador de roscas con la ayuda del vástago
- 5- En caso de agujeros pasantes, usar un rompedor para la muesca

Use

- 1- Drill the thread with a Drill Bit
- 2- Thread with an IZARCOIL tap
- 3- Bevel the external diameter at 90° and remove the burr
- 4- Insert the thread repair using the fitting tool
- 5- In case of through holes, use a pin-breaker for the notch

Emploi

- 1- Percer le filet endommagé avec un foret
- 2- Tarauder avec un taraud IZARCOIL
- 3- Chanfreiner le diamètre extérieur à 90° et retirer les copeaux
- 4- Insérer le réparateur de filets avec l'aide du guide
- 5- Pour trous débouchants, employer un brise-copeaux



Ref. **3300**

INSERTO REPARACIÓN ROSCAS

Thread Repair Insert
Filet rapportés



INOX
304

M/MF

Aceros
Steels
Aciers

Aleaciones Alum.
Alloys / Alliages
Aleaciones Mg Alloys / Alliages

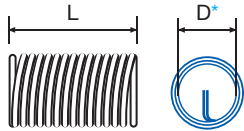

*D = M (aprox.)



M	P	L = 1xD			L = 1,5xD			L = 2xD			L = 2,5xD			L = 3xD		
		Icon	Nº Art.	€ 1 ud.	Icon	Nº Art.	€ 1 ud.	Icon	Nº Art.	€ 1 ud.	Icon	Nº Art.	€ 1 ud.	Icon	Nº Art.	€ 1 ud.
M3	0,50	25	56287		25	56288		25	56289		25	56291		25	56292	
M4	0,70	25	56293		25	56294		25	56297		25	56299		25	56300	
M5	0,80	25	56302		25	56303		25	56304		25	56306		25	56309	
M6+ *	1,00	25	56310		25	56311		25	56312		25	56313		25	56315	
New! M6- *	1,00	25	14857		25	14859		25	14863		25	14865		25	14866	
M7	1,00	25	56316		25	56318		25	56319		25	56320		25	56321	
M8	1,00	25	56322		25	56324		25	56325		25	56326		25	56327	
M8	1,25	25	56332		25	56333		25	56334		25	56336		25	56337	
M9	1,25	25	56339		25	56340		25	56341		25	56342		25	56343	
MF10	1,00	25	56344		25	56345		25	56346		25	56347		25	56348	
MF10	1,25	25	56349		25	56351		25	56352		25	56353		25	56354	
M10	1,50	25	56355		25	56357		25	56360		25	56361		10	56362	
M11	1,50	25	56363		25	56364		10	56365		10	56366		10	56367	
MF12	1,00	25	56369		25	56371		10	56372		10	56373		10	56374	
MF12	1,25	25	56375		25	56377		10	56378		10	56379		10	56381	
MF12	1,50	25	56384		25	56385		10	56387		10	56388		10	56389	
M12	1,75	25	56390		25	56391		10	56392		10	56393		10	56394	
MF14	1,00	10	56395		10	56396		10	56397		10	56399		10	56400	
MF14	1,25	10	56401		10	56402		10	56403		10	56404		10	56405	
MF14	1,50	10	56406		10	56407		10	56408		10	56409		10	56410	
M14	2,00	10	58844		10	58845		10	58846		10	58847		10	58848	
MF16	1,50	10	56411		10	56412		10	56413		10	56414		10	56416	
M16	2,00	10	56417		10	56419		10	56420		10	56422		10	56423	
MF18	2,00	10	56425		10	56427		10	56430		10	56431		10	56433	
M18	2,50	10	56434		10	56436		10	56439		10	56440		10	56442	
M20	2,50	10	67788		10	67790		10	67792		10	67794		10	70628	
M22	2,50	10	56445		10	56446		10	56448		10	56451		10	56452	
MF24	2,00	10	56454		10	56457		10	56458		10	56460		10	56463	
M24	3,00	10	56464		10	56466		10	56467		10	56473		5	56476	

* M6+ → ø7,6 - ø7,7

* M6- → ø7,3 - ø7,4



Ref. **3305**

MACHO PARA INSERTO REPARACIÓN ROSCAS

Thread Repair Insert Tap
Taraud filet rapportés



IZARCOIL

HSS

M/MF

Aceros
Steels
Aciers

Aleaciones Alum.
Alloys / Alliages
Aleaciones Mg Alloys / Alliages



M	P	D mm	d mm	L mm	l mm	a mm	Z	Nº Art.	€
M3	0,50	3,65	4,00	53	13	3,15	3	56615	
M4	0,70	4,91	5,00	58	16	4,00	3	56617	
M5	0,80	6,04	6,30	66	19	5,00	3	56620	
M6	1,00	7,30	8,00	72	22	6,30	3	56622	
M7	1,00	8,30	9,00	72	22	7,10	3	56623	
M8	1,00	9,30	10,00	80	24	8,00	3	56628	
M8	1,25	9,62	10,00	80	24	8,00	3	56626	
M9	1,25	10,60	8,00	85	25	6,30	3	56629	
MF10	1,00	11,30	8,00	85	25	6,30	3	56638	
MF10	1,25	11,62	8,00	85	25	6,30	3	56634	
M10	1,50	11,95	9,00	89	29	7,10	3	56632	
M11	1,50	12,95	9,00	89	29	7,10	3	56640	
MF12	1,00	13,30	11,20	95	30	9,00	3	56646	
MF12	1,25	13,62	11,20	95	30	9,00	3	56648	
MF12	1,50	13,95	11,20	95	30	9,00	3	56647	
M12	1,75	14,27	11,20	95	30	9,00	3	56644	
MF14	1,00	15,30	12,50	102	32	10,00	3	56650	
MF14	1,25	15,62	12,50	102	32	10,00	3	56652	
MF14	1,50	15,95	12,50	102	32	10,00	3	56651	
M14	2,00	16,70	12,50	102	32	10,00	4	58849	
MF16	1,50	18,00	14,00	104	29	11,20	4	56654	
M16	2,00	18,60	14,00	112	37	11,20	4	56653	
MF18	2,00	20,60	14,00	104	29	11,20	4	56657	
M18	2,50	21,30	16,00	118	38	12,50	4	56656	
M20	2,50	23,32	16,00	118	38	12,50	4	72852	
M22	2,50	25,30	18,00	130	45	14,00	4	56658	
MF24	2,00	26,60	20,00	127	37	16,00	4	56660	
M24	3,00	27,90	20,00	138	48	16,00	4	56659	

D Broca Drill Bit / Punta mm
3,20
4,20
5,20
6,30
7,30
8,30
8,30
9,40
10,30
10,30
10,40
11,50
12,30
12,30
12,50
12,50
14,30
14,30
14,50
14,50
16,50
16,50
18,50
18,75
20,75
23,00
24,50
25,00



Ref. **3303**

INSERTADOR

Fitting Tool
Appareil de Pose



M	L mm	D mm		N° Art.	€
M3	132	2,20	1	70226	
M4	132	3,00	1	66774	
M5	132	4,00	1	66775	
M6	132	4,90	1	66776	
M8	132	6,50	1	66777	
M10	132	7,00	1	66778	
M12	132	9,50	1	66779	
M14	132	11,00	1	66780	
M16	132	12,75	1	79464	
M18	132	14,90	1	79466	
M20	132	15,95	1	79467	
M22	132	17,95	1	83203	
M24	132	20,00	1	79468	

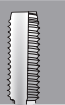

Ref. **3307**

ROMPE ARRASTRES

Pin-Breaker
Rupteur



M	L mm	D mm		N° Art.	€
M3	100	2,20	1	70238	
M4	100	3,00	1	66781	
M5	100	4,00	1	66782	
M6	100	4,90	1	66783	
M8	100	6,50	1	66784	
M10	100	7,00	1	66785	
M12	100	9,50	1	66786	
M14	100	11,00	1	66787	
M16	100	12,75	1	79470	
M18	100	14,90	1	79476	
M20	100	15,95	1	79477	
M22	100	17,95	1	83205	
M24	100	20,00	1	79478	



Ref. **3310**

SET REPARACIÓN ROSCAS

Thread Repair Set
Set filet rapportés



M

Aceros
Steels
Aciers

Aleaciones Alum. Alloys / Alliages
Aleaciones Mg Alloys / Alliages



Set 95 Pcs

Cont. M5-M12				Nº Art.	€
Insertos Inserts Rapportes		M5 0,80	5 pcs 1xD + 5 pcs 1,5xD + 5 pcs 2,5XD	56481	
		M6 1,00	5 pcs 1xD + 5 pcs 1,5xD + 5 pcs 2,5XD		
		M8 1,25	5 pcs 1xD + 5 pcs 1,5xD + 5 pcs 2,5XD		
		M10 1,50	5 pcs 1xD + 5 pcs 1,5xD + 5 pcs 2,5XD		
		M12 1,75	5 pcs 1xD + 5 pcs 1,5xD + 5 pcs 2,5XD		
Brocas Drill Bits Forets (D mm)		5,20 - 6,30 - 8,30 - 10,40 - 12,50			
Machos Taps Tarauds (D mm)		6,04 - 7,30 - 9,62 - 11,95 - 14,27			
Insertadores Fitting Tools Appareils de pose (D mm)		4,00 - 4,50 - 6,25 - 7,20 - 9,50			
Rompe arrastres Pin-Breakers Rupteurs (D mm)		4,00 - 4,50 - 6,25 - 7,20 - 9,50			

Ref. **3311**

SET REPARACIÓN ROSCAS BUJÍAS

Spark Plug Thread Repair Set
Set filet rapportés bougies



M/MF



Aceros
Steels
Aciers

Aleaciones Alum. Alloys / Alliages
Aleaciones Mg Alloys / Alliages



Set 94 Pcs

Cont. M6-M14				Nº Art.	€
Insertos Inserts Rapportes		M6 1,00	5 pcs 1xD + 5 pcs 1,5xD + 5 pcs 2,5XD	56482	
		M8 1,25	5 pcs 1xD + 5 pcs 1,5xD + 5 pcs 2,5XD		
		M10 1,50	5 pcs 1xD + 5 pcs 1,5xD + 5 pcs 2,5XD		
		M12 1,75	5 pcs 1xD + 5 pcs 1,5xD + 5 pcs 2,5XD		
		MF14 1,25	5 pcs 1xD + 5 pcs 1,5xD + 5 pcs 2,5XD		
Brocas Drill Bits Forets (D mm)		6,30 - 8,30 - 10,40 - 12,50			
Machos Taps Tarauds (D mm)		7,30 - 9,62 - 11,95 - 14,27 - 15,60			
Insertadores Fitting Tools Appareils de pose (D mm)		4,50 - 6,25 - 7,20 - 9,50 - 11,00			
Rompe arrastres Pin-Breakers Rupteurs (D mm)		4,50 - 6,25 - 7,20 - 9,50 - 11,00			



Ref. **3312**

SET REPARACIÓN ROSCAS COMPLETO

Complete Thread Repair Set
Set filet rapportés complet



M/MF

**Aceros
Steels
Aciers**

**Aleaciones Alum. Alloys / Alliages
Aleaciones Mg Alloys / Alliages**



Set 19 Pcs

M	P	Insertos Inserts Rapportés	INOX 304	Brocas Drill Bits Forets (D mm)	HSS	Machos Taps Tarauds (D mm)	HSS	Insertadores Fitting Tools Appareils de pose (D mm)	Rompe arrastres Pin-Breakers Rupteurs (D mm)	Nº Art.	€
M3	0,50	5pcs 1xD + 5 pcs 1,5xD + 5 pcs 2,5xD		3,20		3,65		2,20	2,20	60330	
M4	0,70	5 pcs 1xD + 5 pcs 1,5xD + 5 pcs 2,5xD		4,20		4,91		3,00	3,00	56484	
M5	0,80	5 pcs 1xD + 5 pcs 1,5xD + 5 pcs 2,5xD		5,20		6,04		4,00	4,00	56487	
M6	1,00	5 pcs 1xD + 5 pcs 1,5xD + 5 pcs 2,5xD		6,30		7,30		4,90	4,90	56488	
M7	1,00	5 pcs 1xD + 5 pcs 1,5xD + 5 pcs 2,5xD		7,30		8,30		4,90	4,90	67804	
MF8	1,00	5 pcs 1xD + 5 pcs 1,5xD + 5 pcs 2,5xD		8,30		9,30		6,50	6,50	56497	
M8	1,25	5 pcs 1xD + 5 pcs 1,5xD + 5 pcs 2,5xD		8,30		9,62		6,50	6,50	56490	
New! MF10	1,00	5 pcs 1xD + 5 pcs 1,5xD + 5 pcs 2,5xD		10,30		11,30		7,00	7,00	12675	
MF10	1,25	5 pcs 1xD + 5 pcs 1,5xD + 5 pcs 2,5xD		10,30		11,62		7,00	7,00	56500	
M10	1,50	5 pcs 1xD + 5 pcs 1,5xD + 5 pcs 2,5xD		10,40		11,95		7,00	7,00	56493	
MF12	1,00	5 pcs 1xD + 5 pcs 1,5xD + 5 pcs 2,5xD		12,30		13,30		9,50	9,50	57967	
MF12	1,50	5 pcs 1xD + 5 pcs 1,5xD + 5 pcs 2,5xD		12,50		13,95		9,50	9,50	57964	
M12	1,75	5 pcs 1xD + 5 pcs 1,5xD + 5 pcs 2,5xD		12,50		14,27		9,50	9,50	56496	
MF14	1,25	5 pcs 1xD + 5 pcs 1,5xD + 5 pcs 2,5xD		*14,30		15,62		11,00	11,00	57973	
M14	2,00	5 pcs 1xD + 5 pcs 1,5xD + 5 pcs 2,5xD		*14,50		16,60		11,00	11,00	57970	
New! MF16	1,50	5 pcs 1xD + 5 pcs 1,5xD + 5 pcs 2,5xD		*16,50		18,00		12,75	12,75	23220	
New! M16	2,00	5 pcs 1xD + 5 pcs 1,5xD + 5 pcs 2,5xD		*16,50		18,60		12,75	12,75	23221	

* **Diámetro de broca correspondiente. Broca no incluida**
Corresponding drill bit diameter. Drill bit not included
 Diamètre de foret correspondant. Foret non inclus



FRESAS ROTATIVAS

Rotary Burrs

Fraises limes rotatives

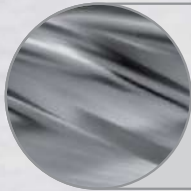

Dentado
Teeth
Denture **1**

MATERIALES NO FERROSOS
Non-Ferrous Materials
Matériaux non ferreux

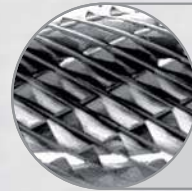

Dentado
Teeth
Denture **6**

MATERIALES DUROS
Hard Materials
Matériaux Durs



Dentado
Teeth
Denture **3**

USO GENERAL
General Purpose
Utilisation Générale



Dentado
Teeth
Denture **M**

INOXIDABLES
Stainless Steels
Aciers Inox

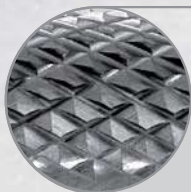

Dentado
Teeth
Denture **4**

VIRUTA CORTA
Short Chipping
Copeaux Courts



Dentado
Teeth
Denture **S**

TITANIO, INCONEL...
Titanium, Inconel...
Titane, Inconel...



Ref. **9260**

FRESA ROTATIVA MD TIPO B

B Type HM Rotary Burr
Fraise lime rotative carbure type B



MD HM Carbure	MD/HM + ALTIM	Tipo B Type	Norma ZYA-S Norm
-----------------------------------	---------------------	--------------------------	-------------------------------

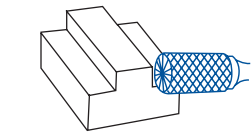
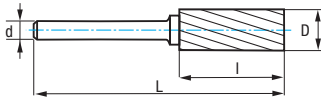

1
MATERIALES NO FERROSOS
Non-Ferrous Materials
Matériaux non ferreux



3
USO GENERAL
General Purpose
Utilisation Générale



4
VIRUTA CORTA
Short Chipping
Copeaux Courts

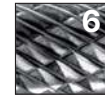

6
MATERIALES DUROS
Hard Materials
Matériaux Durs

D mm	d mm	L mm	l mm	Dentado Teeth / Denture 1		Dentado Teeth / Denture 3		Dentado Teeth / Denture 4		Dentado Teeth / Denture 6	
				Nº Art.	€	Nº Art.	€	Nº Art.	€	Nº Art.	€
3,00	3,00	38,00	14,00	55677		44072		44079		44086	66485
6,00	6,00	50,00	18,00	55680		44074		44081		44141	66486
6,30	3,00	45,00	12,70	55679		44073		44080		44122	
8,00	6,00	64,00	19,00	55681		44075		44082		44142	66487
9,60	6,00	64,00	19,00	44070	55864	44076		44083		44143	43567
12,70	6,00	70,00	25,00	44071	55866	44077		44084		44144	66488
12,70	8,00	70,00	25,00	55691		55689				55690	
16,00	6,00	70,00	25,00	55682		44078		44085		44145	
16,00	8,00	70,00	25,00	55695		55692				55693	
19,00	6,00	70,00	25,00	55685		55683				55684	
25,00	6,00	70,00	25,00	55688		55686				55687	

Ref. **9240**

FRESA ROTATIVA MD TIPO B LARGA

Long B Type HM Rotary Burr
Fraise lime rotative carbure type B longue



MD HM Carbure	Tipo B Type		Norma ZYA-S Norm
-----------------------------------	--------------------------	--	-------------------------------

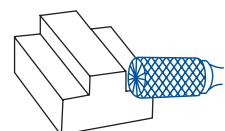
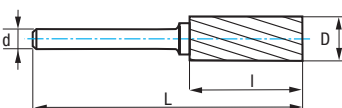

3
USO GENERAL
General Purpose
Utilisation Générale



6
MATERIALES DUROS
Hard Materials
Matériaux Durs

D mm	d mm	L mm	l mm	Dentado Teeth / Denture 3		Dentado Teeth / Denture 6	
				Nº Art.	€	Nº Art.	€
6,00	6,00	150,00	18,00	55832		55833	
9,60	6,00	172,00	19,00	55834		55835	
12,70	6,00	178,00	25,00	55836		55837	



Ref. **9250**

FRESA ROTATIVA MD TIPO A

A Type HM Rotary Burr
Fraise lime rotative carbure type A



MD HM Carbure	MD/HM + ALTIN	Tipo A Type	Norma ZYA Norm
------------------------------	---------------------	----------------------------	-------------------------------

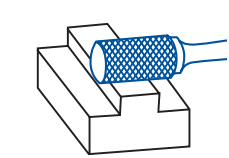
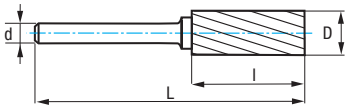

1
MATERIALES NO FERROSOS
Non-Ferrous Materials
Matériaux non ferreux



3
USO GENERAL
General Purpose
Utilisation Générale



4
VIRUTA CORTA
Short Chipping
Copeaux Courts



6
MATERIALES DUROS
Hard Materials
Matériaux Durs

D mm	d mm	L mm	l mm	Dentado Teeth / Denture 1		Dentado Teeth / Denture 1 ALTIN		Dentado Teeth / Denture 3		Dentado Teeth / Denture 4		Dentado Teeth / Denture 6		Dentado Teeth / Denture 6 ALTIN	
				N° Art.	€	N° Art.	€	N° Art.	€	N° Art.	€	N° Art.	€	N° Art.	€
3,00	3,00	38,00	14,00	55644				44149	44156			44245		66489	
6,00	6,00	50,00	18,00	55648				44151	44158			44417		66490	
6,30	3,00	45,00	12,70	55645				44150	44157			44301			
8,00	6,00	64,00	19,00	55651				44152	44159			44418		66491	
9,60	6,00	64,00	19,00	44147		55861		44153	44160			44419		63933	
12,70	6,00	70,00	25,00	44148		55863		44154	44161			44421		66492	
12,70	8,00	70,00	25,00	55671				55669				55670			
16,00	6,00	70,00	25,00	55653				44155	44173			44422			
16,00	8,00	70,00	25,00	55675				55672				55673			
19,00	6,00	70,00	25,00	55664				55655				55657			
25,00	6,00	70,00	25,00	55668				55666				55667			

Ref. **9230**

FRESA ROTATIVA MD TIPO A LARGA

Long A Type HM Rotary Burr
Fraise Lime Rotative Carbure type A longue



MD HM Carbure	Tipo A Type		Norma ZYA Norm
------------------------------	----------------------------	--	-------------------------------



6
MATERIALES DUROS
Hard Materials
Matériaux Durs

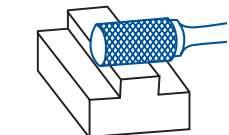
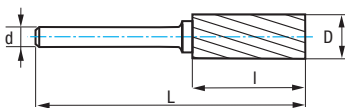

D mm	d mm	L mm	l mm	Dentado Teeth / Denture 6	
				N° Art.	€
6,00	6,00	150,00	18,00	55829	
9,60	6,00	172,00	19,00	55830	
12,70	6,00	178,00	25,00	55831	



Ref. **9251**

FRESA ROTATIVA MD TIPO C RADIAL

Radial C Type HM Rotary Burr

Fraise lime rotative carbure type C hemisphérique



MD HM Carbure	MD/HM + ALTiN	Tipo C Type	Norma WRC Norm
----------------------------	---------------------	--------------------------	-----------------------------

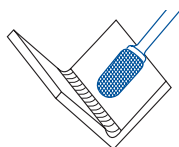
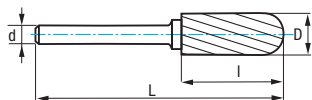

1
MATERIALES NO FERROSOS
Non-Ferrous Materials
Matériaux non ferreux



3
USO GENERAL
General Purpose
Utilisation Générale



4
VIRUTA CORTA
Short Chipping
Copeaux Courts



6
MATERIALES DUROS
Hard Materials
Matériaux Durs



S
TITANIO, INCONEL...
Titanium, Inconel...
Titane, Inconel...

D mm	d mm	L mm	l mm	Dentado Teeth / Denture 1		Dentado Teeth / Denture 3		Dentado Teeth / Denture 4		Dentado Teeth / Denture 6		Dentado Teeth / Denture 6 ALTiN		Dentado Teeth / Denture S ALTiN	
				N° Art.	€	N° Art.	€	N° Art.	€	N° Art.	€	N° Art.	€	N° Art.	€
3,00	3,00	38,00	14,00	55696		44425		44431		44437		66493		83022	
6,00	6,00	50,00	18,00	55698		44426		44432		44438		66494			
8,00	6,00	64,00	18,00	55699		44427		44433		44439		66495			
9,60	6,00	64,00	19,00	44423	55867	44428		44434		44440		66496			
12,70	6,00	70,00	25,00	44424	55868	44429		44435		44441		66497			
12,70	8,00	70,00	25,00	55708		55706				55707					
16,00	6,00	70,00	25,00	12138		44430		44436		44442					
16,00	8,00	70,00	25,00	55711		55709				55710					
19,00	6,00	70,00	25,00	55702		55700				55701					
25,00	6,00	70,00	25,00			55704				55705					

New!



M
INOXIDABLES
Stainless Steels
Aciers Inox

D mm	d mm	L mm	l mm	Dentado Teeth / Denture M	
				N° Art.	€
9,60	6,00	64,00	19,00	20076	
12,70	6,00	70,00	25,00	20080	

Ref. **9231**

FRESA ROTATIVA MD TIPO C RADIAL LARGA

Long Radial C Type HM Rotary Burr

Fraise lime rotative carbure type C hemisphérique longue



MD HM Carbure	Tipo C Type	Norma WRC Norm
----------------------------	--------------------------	-----------------------------

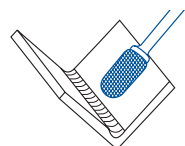
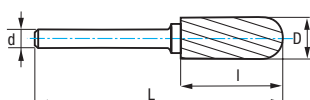

6
MATERIALES DUROS
Hard Materials
Matériaux Durs

D mm	d mm	L mm	l mm	Dentado Teeth / Denture 6	
				N° Art.	€
6,00	6,00	150,00	18,00	55838	
9,60	6,00	172,00	19,00	55839	
12,70	6,00	178,00	25,00	55840	



Ref. **9252**

FRESA ROTATIVA MD TIPO N CONO INVERTIDO

Inverted Cone N Type HM Rotary Burr

Fraise lime rotative carbure type N sans coupe en bout



MD HM Carbure	Tipo N Type	Norma WKN Norm
-----------------------------------	--------------------------	-----------------------------

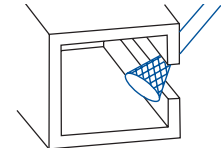
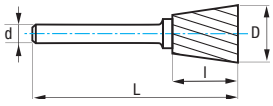

USO GENERAL
General Purpose
Utilisation Générale



VIRUTA CORTA
Short Chipping
Copeaux Courts



MATERIALES DUROS
Hard Materials
Matériaux Durs

D mm	d mm	L mm	l mm	Ang.	Dentado Teeth / Denture 3		Dentado Teeth / Denture 4		Dentado Teeth / Denture 6	
					Nº Art.	€	Nº Art.	€	Nº Art.	€
3,00	3,00	38,00	4,00	10°	44443		44450		44455	
6,00	6,00	50,00	8,00	10°	44447		44452		44458	
6,30	3,00	39,00	6,00	12°	44445		44451		44457	
12,70	6,00	57,00	12,00	28°	44448		44453		44460	
12,70	8,00	58,00	12,70	28°	55825				55826	
16,00	6,00	64,00	19,00	18°	44449		44454		44461	
16,00	8,00	64,00	19,00	18°	55827				55828	
19,00	6,00	61,00	16,00	30°	55823				55824	



Ref. **9254**

FRESA ROTATIVA MD TIPO G OJIVA

Tree G Type HM Rotary Burr

Fraise lime rotative carbure type G ogive



MD HM Carbure	MD/HM + ALTiN	Tipo G Type	Norma SPG Norm
-----------------------------------	---------------------	--------------------------	-----------------------------

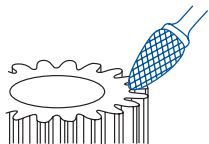
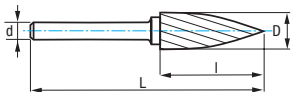

MAT. NO FERROSOS
Non-Ferrous Mat.
Mat. non ferreux



USO GENERAL
General Purpose
Utilisation Générale



VIRUTA CORTA
Short Chipping
Copeaux Courts



MATERIALES DUROS
Hard Materials
Matériaux Durs



New!

INOXIDABLES
Stainless Steels
Aciers Inox

D mm	d mm	L mm	l mm	Dentado Teeth / Denture 1		Dentado Teeth / Denture 3		Dentado Teeth / Denture 4		Dentado Teeth / Denture 6		Dentado Teeth / Denture 6 ALTiN		Dentado Teeth / Denture M	
				Nº Art.	€	Nº Art.	€	Nº Art.	€	Nº Art.	€	Nº Art.	€	Nº Art.	€
3,00	3,00	38,00	14,00	55783		44466		44472		44487		66505			
6,00	6,00	50,00	18,00	55784		44467		44473		44488		66506			
8,00	6,00	64,00	19,00	55785		44468		44474		44494					
9,60	6,00	64,00	19,00	44463		44469		44475		44500		55882		20087	
12,70	6,00	70,00	25,00	44464		44470		44476		44512		27566		20088	
12,70	8,00	70,00	25,00	55787		17105				55786					
16,00	6,00	70,00	25,00					44482							
16,00	6,00	75,00	30,00	44465		44471				44518					
16,00	8,00	70,00	25,00	55790		55788				55789					



Ref. **9255**

FRESA ROTATIVA MD TIPO M CÓNICA

Cone M Type HM Rotary Burr

Fraise lime rotative carbure type M conique



MD
HM
Carbure

Tipo
M
Type

Norma
SKM
Norm

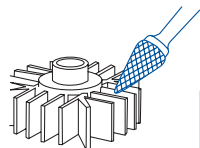
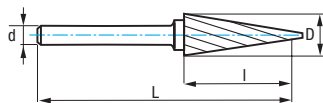

1
MAT. NO FERROSOS
Non-Ferrous Mat.
Mat. non ferreux



3
USO GENERAL
General Purpose
Utilisation Générale



4
VIRUTA CORTA
Short Chipping
Copeaux Courts



6
MATERIALES DUROS
Hard Materials
Matériaux Durs

D mm	d mm	L mm	l mm	Ang.	Dentado Teeth / Denture 1		Dentado Teeth / Denture 3		Dentado Teeth / Denture 4		Dentado Teeth / Denture 6	
					Nº Art.	€	Nº Art.	€	Nº Art.	€	Nº Art.	€
6,00	6,00	50,00	20,00	14°	55817		44530		44598		44616	
6,30	3,00	49,00	12,70	22°	55816		44524		44595		44613	
8,00	6,00	64,00	18,00	22°			44583		44601		44617	
9,60	6,00	64,00	16,00	28°	55818		44586		44604		44619	
12,70	6,00	71,00	22,00	28°	25335		44589		44607		44620	
12,70	8,00	71,00	22,00	28°			55819				55820	
16,00	6,00	71,00	25,00	31°			44592		44610		44622	
16,00	8,00	71,00	25,00	31°			55821				55822	

Ref. **9256**

FRESA ROTATIVA MD TIPO K CÓNICA 90°

90° Cone K Type HM Rotary Burr

Fraise lime rotative carbure type K conique 90°



MD
HM
Carbure

Tipo
K
Type

Norma
KSK
Norm

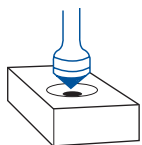
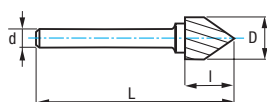

3
USO GENERAL
General Purpose
Utilisation Générale



4
VIRUTA CORTA
Short Chipping
Copeaux Courts



6
MATERIALES DUROS
Hard Materials
Matériaux Durs

D mm	d mm	L mm	l mm	Dentado Teeth / Denture 3		Dentado Teeth / Denture 4		Dentado Teeth / Denture 6	
				Nº Art.	€	Nº Art.	€	Nº Art.	€
6,00	6,00	50,00	3,00	44625		44628		44631	
12,70	6,00	55,00	6,30	44626		44629		44632	
12,70	8,00	55,00	6,30	55802				55803	
16,00	6,00	57,00	8,00	55796				55797	
16,00	8,00	57,00	8,00	55804				55805	
19,00	6,00	59,00	9,50	55798				55799	
25,00	6,00	61,00	12,70	55800				55801	



Ref. **9257**

FRESA ROTATIVA MD TIPO E GOTA

Oval E Type HM Rotary Burr
Fraise lime rotative carbure type E ovale



MD HM Carbure	Tipo E Type	Norma TRE Norm
----------------------------	--------------------------	-----------------------------



New!

INOXIDABLES
Stainless Steels
Aciers Inox

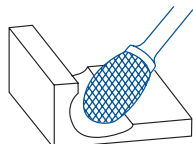
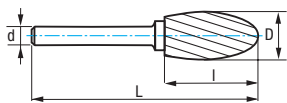

1
MAT. NO FERROSOS
Non-Ferrous Mat.
Mat. non ferreux



3
USO GENERAL
General Purpose
Utilisation Générale



4
VIRUTA CORTA
Short Chipping
Copeaux Courts



6
MATERIALES DUROS
Hard Materials
Matériaux Durs

D mm	d mm	L mm	l mm	Dentado Teeth / Denture 1		Dentado Teeth / Denture 3		Dentado Teeth / Denture 4		Dentado Teeth / Denture 6		Dentado Teeth / Denture M	
				Nº Art.	€	Nº Art.	€	Nº Art.	€	Nº Art.	€	Nº Art.	€
3,00	3,00	38,00	6,00	55733		44637		44648		44655			
6,00	6,00	50,00	10,00	55735		44640		44650		44657			
6,30	3,00	42,00	9,50	55734		44638		44649		44656			
8,00	6,00	60,00	15,00	55737		44643		44651		44658			
9,60	6,00	61,00	16,00	44634		44644		44652		44659		20652	
12,70	6,00	67,00	22,00	44635		44646		44653		44660		20653	
12,70	8,00	67,00	22,00	55746		55743				55744			
16,00	6,00	70,00	25,00	55738		44647		44654		44661			
16,00	8,00	70,00	25,00	55749		55747				55748			
19,00	6,00	70,00	25,00	55741		55739				55740			

Ref. **9237**

FRESA ROTATIVA MD TIPO E GOTA LARGA

Long Oval E Type HM Rotary Burr
Fraise lime rotative carbure type E ovale longue



MD HM Carbure	Tipo E Type	Norma TRE Norm
----------------------------	--------------------------	-----------------------------

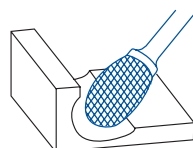
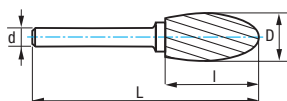

3
USO GENERAL
General Purpose
Utilisation Générale



6
MATERIALES DUROS
Hard Materials
Matériaux Durs

D mm	d mm	L mm	l mm	Dentado Teeth / Denture 3		Dentado Teeth / Denture 6	
				Nº Art.	€	Nº Art.	€
9,60	6,00	168,00	16,00	55849		55851	
12,70	6,00	184,00	22,00	55852		55854	



Ref. **9258**

FRESA ROTATIVA MD TIPO D ESFÉRICA

Ball D Type HM Rotary Burr

Fraise lime rotative carbure type D sphérique



MD HM Carbure	MD/HM + ALTIM	Tipo D Type	Norma KUD Norm
----------------------------	---------------------	--------------------------	-----------------------------

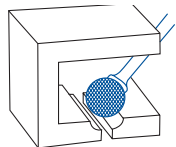
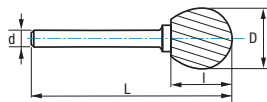

MATERIALES NO FERROSOS
Non-Ferrous Materials
Matériaux non ferreux



USO GENERAL
General Purpose
Utilisation Générale



VIRUTA CORTA
Short Chipping
Copeaux Courts



MATERIALES DUROS
Hard Materials
Matériaux Durs

D mm	d mm	L mm	I mm	Dentado Teeth / Denture 1		Dentado Teeth / Denture 1 ALTIM		Dentado Teeth / Denture 3		Dentado Teeth / Denture 4		Dentado Teeth / Denture 6		Dentado Teeth / Denture 6 ALTIM	
				N° Art.	€	N° Art.	€	N° Art.	€	N° Art.	€	N° Art.	€	N° Art.	€
3,00	3,00	38,00	2,50	55713				44705		44712		44719		66498	
6,00	6,00	50,00	4,70	55716				44707		44714		44721		66499	
6,30	3,00	38,00	5,00	55714				44706		44713		44720			
8,00	6,00	52,00	6,00	55717				44708		44715		44722		66500	
9,60	6,00	54,00	8,00	44662		55869		44709		44716		44723		66501	
12,70	6,00	56,00	11,00	44671		55870		44710		44717		44724		66502	
12,70	8,00	56,00	11,00	55728				55725				55726			
16,00	6,00	59,00	14,00	58481				44711		44718		44725			
16,00	8,00	59,00	14,00	55732				55729				55731			
19,00	6,00	62,00	16,50	55720				55718				55719			
25,00	6,00	67,00	22,00	55724				55722				55723			

New!



INOXIDABLES
Stainless Steels
Aciers Inox

D mm	d mm	L mm	I mm	Dentado Teeth / Denture M	
				N° Art.	€
9,60	6,00	54,00	8,00	20081	
12,70	6,00	56,00	11,00	20082	

Ref. **9238**

FRESA ROTATIVA MD TIPO D ESFÉRICA LARGA

Long Ball D Type HM Rotary Burr

Fraise lime rotative carbure type D sphérique longue

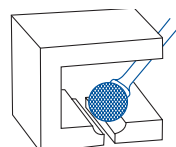
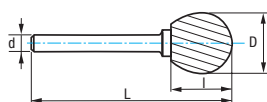

MD HM Carbure	Tipo D Type	Norma KUD Norm
----------------------------	--------------------------	-----------------------------



USO GENERAL
General Purpose
Utilisation Générale



MATERIALES DUROS
Hard Materials
Matériaux Durs

D mm	d mm	L mm	I mm	Dentado Teeth / Denture 3		Dentado Teeth / Denture 6	
				N° Art.	€	N° Art.	€
8,00	6,00	182,00	6,00	55841		55842	
9,60	6,00	170,00	8,00	55843		55845	
12,70	6,00	175,00	11,00	55846		55848	



Ref. **9266**

FRESA ROTATIVA MD TIPO H LLAMA

Flame H Type HM Rotary Burr

Fraise lime rotative carbure type H flamme



MD
HM
Carbure

Tipo
H
Type

Norma
B
Norm

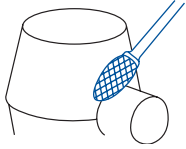
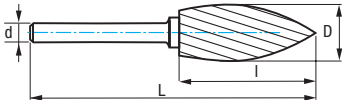

1
MAT. NO FERROSOS
Non-Ferrous Mat.
Mat. non ferreux



3
USO GENERAL
General Purpose
Utilisation Générale



4
VIRUTA CORTA
Short Chipping
Copeaux Courts



6
MATERIALES DUROS
Hard Materials
Matériaux Durs

D mm	d mm	L mm	I mm	Dentado Teeth / Denture 1		Dentado Teeth / Denture 3		Dentado Teeth / Denture 4		Dentado Teeth / Denture 6	
				N° Art.	€	N° Art.	€	N° Art.	€	N° Art.	€
3,00	3,00	38,00	6,00			44728		44735		44757	
6,00	3,00	43,00	10,00			44729		44736		44760	
6,00	6,00	50,00	14,00			44730		44737		44763	
8,00	6,00	64,00	19,00	55791		44731		44738		44766	
9,60	6,00	65,00	19,00	44726		44732		44739		44769	
12,70	6,00	77,00	32,00	44727		44733		44740		44771	
12,70	8,00	77,00	32,00			55792				55793	
16,00	6,00	81,00	36,00	44773		44734		44742		44772	
16,00	8,00	81,00	36,00			55794				55795	



Ref. **9267**

FRESA ROTATIVA MD TIPO L CÓNICA REDONDEADA

Ball Nosed Cone L Type HM Rotary Burr
Fraise lime rotative carbure type L conique rayon



MD
HM
Carbure

Tipo
L
Type

Norma
KEL
Norm

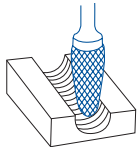
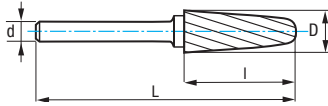

1
MAT. NO FERROSOS
Non-Ferrous Mat.
Mat. non ferreux



3
USO GENERAL
General Purpose
Utilisation Générale



4
VIRUTA CORTA
Short Chipping
Copeaux Courts



6
MATERIALES DUROS
Hard Materials
Matériaux Durs

D mm	d mm	L mm	l mm	Ang.	Dentado Teeth / Denture 1		Dentado Teeth / Denture 1 ALTIN		Dentado Teeth / Denture 3		Dentado Teeth / Denture 4		Dentado Teeth / Denture 6		Dentado Teeth / Denture 6 ALTIN	
					Nº Art.	€	Nº Art.	€	Nº Art.	€	Nº Art.	€	Nº Art.	€	Nº Art.	€
3,00	3,00	38,00	14,00	10°	55806				44776		44783		44790		66507	
6,00	6,00	50,00	18,00	14°	55808				44778		44785		44792			
6,30	3,00	48,00	15,80	22°	55807				44777		44784		44791			
8,00	6,00	70,00	25,40	14°	55809				44779		44786		44793			
10,00	6,00	65,00	20,00	14°	21959				44780		44787		44794			
12,70	6,00	77,00	32,00	14°	44774		66508		44781		44788		44795		20159	
12,70	8,00	77,00	32,00	14°	55812				55810				55811			
16,00	6,00	78,00	33,00	14°	44775				44782		44789		44796			
16,00	8,00	78,00	33,00	14°	55815				55813				55814			

Ref. **9247**

FRESA ROTATIVA MD TIPO L CÓNICA REDONDEADA LARGA

Long Ball Nosed Cone L Type HM Rotary Burr
Fraise lime rotative carbure type L conique rayon longue



MD
HM
Carbure

Tipo
L
Type

Norma
KEL
Norm



6
MATERIALES DUROS
Hard Materials
Matériaux Durs

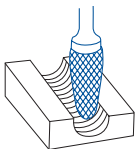
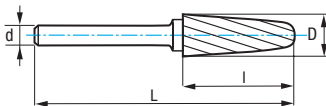

D mm	d mm	L mm	l mm	Ang.	Dentado Teeth / Denture 6	
					Nº Art.	€
9,60	6,00	183,00	30,00	14°	55858	
12,70	6,00	185,00	30,20	14°	55860	



Ref. **9268**

FRESA ROTATIVA MD TIPO F OJIVA REDONDEADA

Ball Nosed Tree F Type HM Rotary Burr
Fraise lime rotative carbure type F Ogive Rayon



MD HM Carbure	MD/HM + ALTIM	Tipo F Type	Norma RBF Norm
-----------------------------------	---------------------	--------------------------	-----------------------------

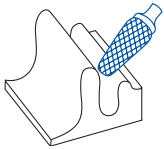
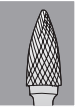
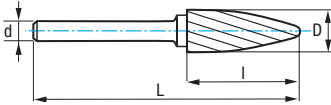

MATERIALES NO FERROSOS
Non-Ferrous Materials
Matériaux non ferreux



USO GENERAL
General Purpose
Utilisation Générale



VIRUTA CORTA
Short Chipping
Copeaux Courts



MATERIALES DUROS
Hard Materials
Matériaux Durs

D mm	d mm	L mm	l mm	Dentado Teeth / Denture 1		Dentado Teeth / Denture 1 ALTIM		Dentado Teeth / Denture 3		Dentado Teeth / Denture 4		Dentado Teeth / Denture 6		Dentado Teeth / Denture 6 ALTIM	
				Nº Art.	€	Nº Art.	€	Nº Art.	€	Nº Art.	€	Nº Art.	€	Nº Art.	€
3,00	3,00	38,00	14,00	55753				55750				17118		66503	
6,00	6,00	50,00	18,00	55759				44797		44802		44808		66504	
6,30	3,00	45,00	12,70	55758				55755				55756			
8,00	6,00	65,00	20,00	55760				44798		44803		44809			
9,60	6,00	64,00	19,00	55761		55880		44799		44804		44811		17250	
12,70	6,00	70,00	25,00	55762		55881		44800		44805		44814		23849	
12,70	8,00	70,00	25,00	55777				55774				55776			
16,00	6,00	70,00	25,00	55765				44801		44806		44817			
16,00	8,00	70,00	25,00	55782				55779				55780			
19,00	6,00	83,00	38,00	55771				55768				55769			

New!



INOXIDABLES
Stainless Steels
Aciers Inox

D mm	d mm	L mm	l mm	Dentado Teeth / Denture M	
				Nº Art.	€
9,60	6,00	64,00	19,00	20083	
12,70	6,00	70,00	25,00	20085	

Ref. **9248**

FRESA ROTATIVA MD TIPO F OJIVA REDONDEADA LARGA

Long Ball Nosed Tree F Type HM Rotary Burr
Fraise lime rotative carbure type F ogive rayon longue

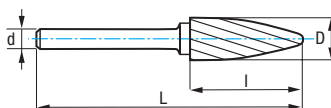

MD HM Carbure	Tipo F Type	Norma RBF Norm
-----------------------------------	--------------------------	-----------------------------



MATERIALES DUROS
Hard Materials
Matériaux Durs

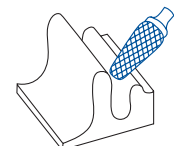

D mm	d mm	L mm	l mm	Dentado Teeth / Denture 6	
				Nº Art.	€
9,60	6,00	172,00	19,00	55855	
12,70	6,00	178,00	25,00	55857	



Ref. **9200**

JUEGOS FRESAS ROTATIVAS MD

HM Rotary Burr Sets

Jeux fraises limes rotatives carbure



Mod. 1
Set 5 Pcs



MAT. NO FERROSOS
Non-Ferrous Mat.
Mat. non ferreux



MATERIALES DUROS
Hard Materials
Matériaux Durs

Cont. (1 x ref.)	D mm	d mm	Dentado Teeth / Denture 1		Dentado Teeth / Denture 6	
			Nº Art.	€	Nº Art.	€
9260						
9251	12,70	6,00	60052		45810	
9255						
9258	9,60	6,00			68857	
9266						



Mod. 2
Set 10 Pcs



MATERIALES DUROS
Hard Materials
Matériaux Durs

Cont. (1 x ref.)	D mm	d mm	Dentado Teeth / Denture 6	
			Nº Art.	€
9260				
9250				
9251				
9254				
9255	6,00	6,00	45811	
9257				
9258				
9266				
9267				
9268				



Mod. 3
Set 8 Pcs



MATERIALES DUROS
Hard Materials
Matériaux Durs

Cont. (1 x ref.)	D mm	d mm	Dentado Teeth / Denture 6	
			Nº Art.	€
9260				
9250				
9251				
9254	3,00	3,00	45813	
9257				
9258				
9267				
9268				



Mod. 4
Set 3 Pcs



MATERIALES DUROS
Hard Materials
Matériaux Durs

Cont. (1 x ref.)	D mm	d mm	Dentado Teeth / Denture 6	
			Nº Art.	€
9260				
9251	9,60	6,00	79826	
9254				



New!

Mod. 5
Set 5 Pcs



INOXIDABLES
Stainless Steels
Aciers Inox

Cont. (1 x ref.)	D mm	d mm	Dentado Teeth / Denture M	
			Nº Art.	€
9251				
9254	12,70	6,00	84379	
9257				
9258	9,60	6,00	84380	
9268				



Expo - Ref. 9200



Set 48 Pcs

Nº Art.	€
57079	

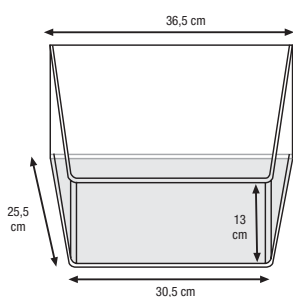

Dentado
Teeth / Denture
6

Ref.	Diam. mm	Nº Art.	Uds
9260	06,00X06,00	44141	2
	08,00X06,00	44142	2
	09,60X06,00	44143	2
	12,70X06,00	44144	2
9251	06,00X06,00	44438	2
	08,00X06,00	44439	2
	09,60X06,00	44440	2
	12,70X06,00	44441	2
9254	06,00X06,00	44488	2
	08,00X06,00	44494	2
	09,60X06,00	44500	2
	12,70X06,00	44512	2
9258	06,00X06,00	44721	2
	08,00X06,00	44722	2
	09,60X06,00	44723	2
	12,70X06,00	44724	2
9267	06,00X06,00	44792	2
	08,00X06,00	44793	2
	10,00X06,00	44794	2
	12,70X06,00	44795	2
9268	06,00X06,00	44808	2
	08,00X06,00	44809	2
	09,60X06,00	44811	2
	12,70X06,00	44814	2

Línea 33 cm - Ref. 9200



Ref	9251	9251	9251	9251	9260	9260
Diam	6×6	8×6	9,6×6	12,7×6	9,6×6	12,7×6
Dent./Teeth	6	6	6	6	6	6
Pcs.	2	2	2	2	2	2

Ref. 4995 - Nº Art. 71009: €



JUEGOS FRESAS ROTATIVAS MD CALIDAD PROFESIONAL
 Professional Quality HM Rotary Burr Sets
 Jeux fraises limes rotatives MD qualité professionnelle



6 Sets

N° Art.	€
58925	



Set 8 Pcs

N° Art.	€
58922	

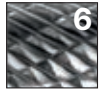
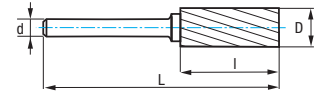

Cont.

Tipo Type	D mm	d mm	L mm	l mm
D	6	6	52	5
	10	6	53	9
C	6	6	61	16
	10	6	65	20
F	10	6	65	20
	12	6	70	25
B	10	6	65	20
	12	6	70	25



6 Sets

N° Art.	€
58928	



Set 10 Pcs

N° Art.	€
58920	

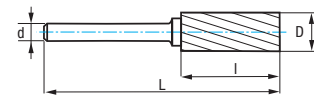

Cont.

Tipo Type	D mm	d mm	L mm	l mm
L	6	6	61	16
	10	6	70	25
F	6	6	63	18
	10	6	65	20
B	6	6	61	16
	10	6	65	20
C	6	6	61	16
	10	6	65	20
E	6	6	61	16
D	8	6	52	7

Ref. **9674**

FRESA RANURADO ALUCOBOND / DIBOND

Alucobond / Dibond Sheet Bending End Mill
Fraise rainurage Alucobond/Dibond



**MD
HM
Carbure**

IZAR
Std.



12000-
15000
rpm

Vf: 400-600
mm/min

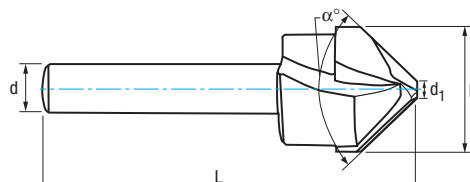

90°



2,5 mm

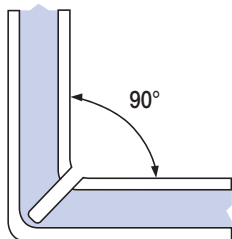
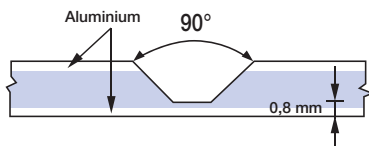

135°



2,3 mm

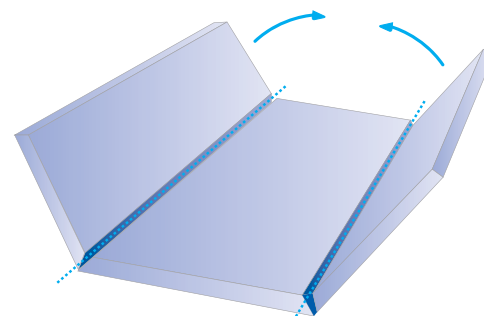
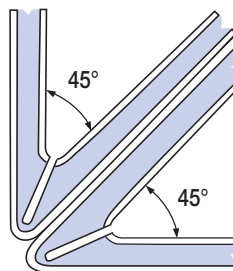
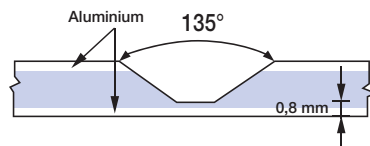

- Fresa especial para ranurados en Alucobond, Dibond, Durabond, Alupanel, Plexiglas, Alpolic, ACP, ACM...
- Se recomienda cortar casi hasta el fondo para poder doblar las planchas fácilmente.
- Special end mill for bending sheets of Alucobond, Dibond, Durabond, Alupanel, Plexiglas, Alpolic, ACP, ACM...
- The material should be cut almost until the bottom part leaving little amount of material left, that way the sheet will be bended easily.
- Fraise spéciale pour rainurage sur Alucobond, Dibond, Durabond, Alupanel, Plexiglas, Alpolic, ACP, ACM...
- Il est recommandé de couper presque jusqu'au fond pour pouvoir plier les plaques facilement.

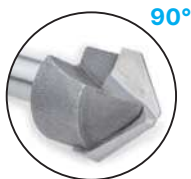

90°



135°

D mm	d mm	L mm	d ₁ mm	α °	N° Art.	€
α=90°						
16	8	59	2,5	90	81516	
18	8	59	2,5	90	81519	
20	8	59	2,5	90	81520	



D mm	d mm	L mm	d ₁ mm	α °	N° Art.	€
α=135°						
16	8	59	2,3	135	81521	
18	8	59	2,3	135	81522	
20	8	59	2,3	135	81523	



Ref. **9459**

FRESA 1Z GRABADO

1Z Engraving End Mill
Fraise 1Z gravure

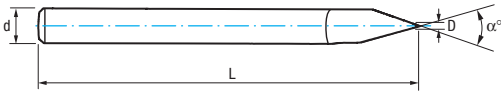

MD/HM/ Carbure Micrograno	DIN 6535 HA	1Z	IZAR std.	6000- 10000 r.p.m.
--	----------------	----	--------------	--------------------------

Aceros
<850 N/mm²
Steel / Aciers

Cobre
Copper
Cuivre

Aluminio
Aluminium

Plásticos
Plastics
Plastiques

Madera
Wood
Bois

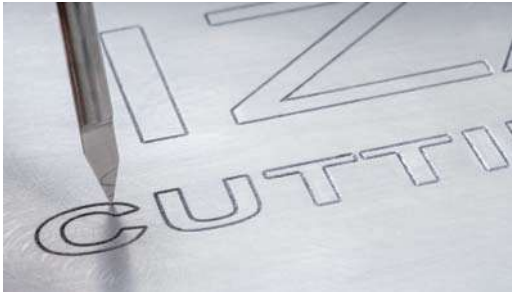

- **Afilado especial para grabado de metales, plásticos y maderas como: Aluminio, Cobre, Hierro, PVC, ABS, Metacrilato acrílico, Paneles bicolores, Madera MDF, etc.**
- **Specially designed geometry for engraving on Metal, Plastic and Wood. Valid for Aluminum, Copper, Iron, PVC, ABS, Acrylic, Bi-color panel, MDF fibreboard, etc.**
- **Géométrie spécial pour gravure de métaux, plastiques et bois telles que: Aluminium, cuivre, fer, PVC, ABS, méthacrylate acrylique, panneaux bicolores, bois MDF, etc.**

D	d	L	N°	€	D	d	L	N°	€	D	d	L	N°	€	D	d	L	N°	€
mm	mm	mm	Art.		mm	mm	mm	Art.		mm	mm	mm	Art.		mm	mm	mm	Art.	
α=30°					α=45°					α=60°					α=90°				
0,1	3,00	38	81048		0,1	3,00	38	81052		0,1	3,00	38	81055		0,1	3,00	38	81058	
0,2	3,00	38	81049		0,2	3,00	38	81053		0,2	3,00	38	81056		0,2	3,00	38	81059	
0,4	3,00	38	81050		0,2	4,00	45	81062		0,2	4,00	45	81065		0,2	4,00	45	81068	
0,8	3,00	38	81051		0,2	6,00	50	81071		0,2	6,00	50	81080		0,2	6,00	50	81084	
					0,4	3,00	38	81054		0,4	3,00	38	81057		0,4	3,00	38	81060	
					0,4	4,00	45	81063		0,4	4,00	45	81066		0,4	4,00	45	81069	
					0,4	6,00	50	81072		0,4	6,00	50	81081		0,4	6,00	50	81086	
					0,8	4,00	45	81064		0,8	4,00	45	81067		0,8	4,00	45	81070	
					0,8	6,00	50	81077		0,8	6,00	50	81082		0,8	6,00	50	81088	
					2,0	6,00	50	81079		2,0	6,00	50	81083		2,0	6,00	50	81089	

ALTIN bajo demanda / upon request / sur demande



Set 4 Pcs



Cont. D mm	N° Art.	€
0,1 mm 30° 0,2 mm 30° 0,4 mm 30° 0,8 mm 30°	81958	

Cont. D mm	N° Art.	€
0,1 mm 30° 0,1 mm 45° 0,1 mm 60° 0,1 mm 90°	81959	



Ref. **9419**

FRESA FRONTAL ACABADO METAL DURO 1Z ALTO RENDIMIENTO

High Performance 1Z HM Finishing End Mill
Fraise finition carbure 1Z haut rendement



MD/HM
Carbure
Micrograno+

ALTIN

W



Tol.
D (h10)
d (h6)



ALTIN

Mayor resistencia al desgaste
Higher Wear Resistance
Plus haute à l'usure



Aluminio
Aluminium

Plásticos
Plastics
Plastiques

D mm	d mm	L mm	l mm	Z	Nº Art. MD/HM	€	Nº Art. ALTIN	€
3,00	3,00	38	12	1	58984		59195	
4,00	4,00	40	15	1	58856		59196	
5,00	5,00	50	16	1	58857		59197	
6,00	6,00	50	18	1	58859		59198	
8,00	8,00	63	22	1	58860		59199	
10,00	10,00	72	30	1	58862		59201	



Ref. **9411**

FRESA FRONTAL 1Z ALUMINIO METAL DURO

HM Aluminium 1Z End Mill
Fraise 1Z Aluminium carbure



MD/HM
Carbure
Micrograno+

ALTIN

W



Tol.
D (h10)
d (h6)



ALTIN

Mayor resistencia al desgaste
Higher Wear Resistance
Plus haute à l'usure



Aluminio
Aluminium

Plásticos
Plastics
Plastiques

D mm	d mm	L mm	l mm	Z	Nº Art. MD/HM	€	Nº Art. ALTIN	€
3,00	3,00	38	12	1	13075		13114	
4,00	4,00	40	12	1	13078		13123	
5,00	5,00	50	12	1	13084		13126	
6,00	6,00	50	14	1	13096		13135	
8,00	8,00	63	15	1	13105		13138	
10,00	10,00	72	15	1	13111		13144	



Ref. **4412**

FRESA FRONTAL ACABADO HSS 1Z ALUMINIO

Aluminium 1Z HSS Finishing End Mill
Fraise finition HSS 1Z Aluminium



HSS	IZAR Std. W	Serie Corta Short Length Série courte	DIN 1835 A	d= 8-10 mm	Tol.* D (k10) d (h6)	* $\varnothing D = \varnothing d \Rightarrow$ Tol. D (js14) d (h6)
------------	-------------------	--	---------------	---------------	----------------------------	--

Aluminio
Aluminium

Termoplásticos
Thermoplastics
Thermoplastiques



D mm	d mm	L mm	l mm	Z	Nº Art.	€
3,00	8	60	12	1	44087	
4,00	8	60	12	1	44090	
5,00	8	60	12	1	44093	
6,00	8	60	14	1	44096	
7,00	8	60	14	1	44099	
8,00	8	80	15	1	44102	
10,00	10	80	15	1	44105	



Ref. **4414**

FRESA FRONTAL ACABADO HSS 1Z ALUMINIO

Aluminium 1Z HSS Finishing End Mill
Fraise finition HSS 1Z Aluminium



HSS	IZAR Std. W	Serie Larga Long Series Série longue	DIN 1835 A	d= 8-10 mm		Tol.* D (k10) d (h6)	* $\varnothing D = \varnothing d \Rightarrow$ Tol. D (js14) d (h6)
------------	-------------------	---	---------------	---------------	---	----------------------------	--

Aluminio
Aluminium

Termoplásticos
Thermoplastics
Thermoplastiques



D mm	d mm	L mm	l mm	Y mm	Z	Nº Art.	€
4,00	8	80	16	29	1	44120	
5,00	8	80	16	29	1	44123	
6,00	8	90	16	29	1	44126	
8,00	8	100	28	40	1	44129	
10,00	10	120	40	40	1	29178	



HOJAS DE SIERRA DE CINTA

Band Saw Blades

Lames de scie à ruban

SELECCIÓN DE LA HOJA CORRECTA

Selecting the right Blade / Selection adaptée

1. Longitud de la Cinta (L)

La dimensión de la cinta depende únicamente de la máquina de corte empleada.

1. Band Length (L)

The band dimension individually depends on the used cutting machine.

1. Longueur de Lame (L)

La dimension d'une lame dépend de la machine utilisée.

2. Ancho de la Cinta (A)

En las máquinas horizontales la anchura de la cinta es especificada por el fabricante. Las máquinas verticales permiten mayores variaciones en la anchura de la cinta.

Sin embargo, la norma general es que cuanto más ancha es la hoja de sierra de cinta, mayor es su estabilidad.

Para el corte de contornos, el radio más pequeño a cortar limita el ancho de la cinta.

2. Band Width (A)

With horizontal machines the band width is specified by the manufacturer.

Vertical band saw machines allow higher variations of the band width.

However, the general rule is the wider the band saw blade the higher its stability.

In case of contour cuts the smallest radius to be cut is the limiting factor for the band width.

2. Largeur de la Lame (A)

Sur des machines horizontales, la largeur de la lame est spécifiée par le fabricant.

Les machines verticales permettent de plus grandes variations dans les largeurs de lames.

La règle est généralement la suivante: Plus la lame est large, plus la rigidité est importante.

En cas de contournage, la largeur du ruban est limitée par le plus petit rayon à scier.

3. Espesor de la Cinta (E)

Cuanto más ancha es la hoja de sierra de cinta, mayor es su espesor.

3. Band Thickness (E)

The wider the band saw blade the higher its thickness.

3. Epaisseur de Lame (E)

Plus la lame est large, plus la épaisseur est importante.

4. Dentado (TPI)

El dentado es el nº de dientes por pulgada (25,4 mm).

Los dentados se diferencian en constantes, paso de diente uniforme, y variables, con diferente paso de diente dentro de cada intervalo.

Los dentados variables se definen con dos medidas, p.e. 2-3 TPI: 2 TPI significa el paso de diente máximo, y 3 TPI significa el paso de diente mínimo en el intervalo de dentado.

Aquí, la longitud de contacto de la sierra de cinta con la pieza a cortar es decisiva.

4. Tooth pitch (TPI)

Tooth pitch is the number of teeth per inch (25,4 mm).

A difference is made between constant tooth pitches with regular tooth distance and variable tooth pitches with differing tooth distance within one interval.

Variable tooth pitches are marked by two measures, e.g. 2-3 TPI: 2 TPI signifies the maximum tooth distance and 3 TPI signifies the minimum tooth distance in the toothing interval.

Here the contact length of the blade in the work piece is decisive.

4. Dentures (TPI)

La dentura es el nº de dientes por pulgada (25,4 mm).

Una diferencia reside entre las denturas constantes, o el écart entre dos puntas de dente reste égal et les dentures variables, ou les valeurs des pas de dents sont différents.

La dentura variable est caractérisée par deux chiffres, p.e. 2-3 TPI: 2 TPI désigne l'écart maxi entre les dents et le chiffre 3 TPI l'écart mini entre les dents sur une séquence de denture.

La surface de contact de la lame sur la pièce à débiter est décisive.

5. Forma Diente (TZ)

Diente estándar (S)

Angulo desprendimiento 0°:

- materiales de viruta corta
- aceros de alto contenido en carbono
- preferiblemente acero de herramienta y hierro fundido
- materiales de poca sección de corte
- perfiles de pared delgada

5. Tooth Shape (TZ)

Raker tooth (S)

0° rake angle for:

- short-chipping materials
- steels with high carbon content
- preferably tool steel and cast iron
- materials with small cross-sections
- thin-walled profiles

5. Forme de Dent (TZ)

Dent standard (S)

Angle de coupe 0° pour:

- matériaux à copeaux courts
- aciers à forte teneur en carbone
- les fontes et aciers à outil
- pièces de petites sections
- profils à parois minces

Diente de garra (K)

Angulo de desprendimiento positivo para macizos:

- empleo universal
- metales no ferrosos y aceros con un contenido en carbono de < 0,8%
- aceros estructurales, aceros para extrusión en frío y aceros templados

Hook tooth (K)

Positive rake angle for solids:

- universal use
- non-ferrous metals and steels with a carbon content of < 0,8%
- structural steels, steels for cold extrusion, tempered steels

Dent griffe (K)

Angle de coupe positif pour matériaux pleins:

- usage universel
- métaux non ferreux et aciers à teneur en carbone de < 0,8%
- aciers de construction, aciers pour extrusion à froid et aciers trempés

Ancho cinta y radio más pequeño

Band widths and smallest radius

Largeurs de lames et plus petit rayon

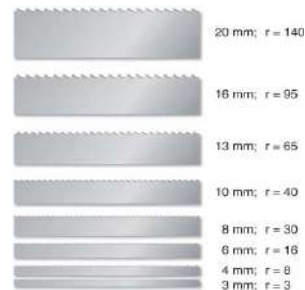

Dentado constante

Constant tooth pitch

Denture constante



Dentado variable

Variable tooth pitch

Denture variable



Tabla selección dentado

Tooth selection table

Dentado Tooth Denture	Perfil Profile Profil	Macizo Solid Plein
10 / 14	0-1 mm	0-10 mm
8 / 12	1-2,5 mm	10-20 mm
6 / 10	2,5-5 mm	20-40 mm
5 / 8	5-7 mm	40-50 mm
4 / 6	7-10 mm	50-90 mm
3 / 4	>10 mm	90-120 mm
2 / 3		>120 mm
1,4 / 2		>250 mm

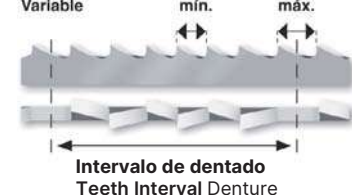
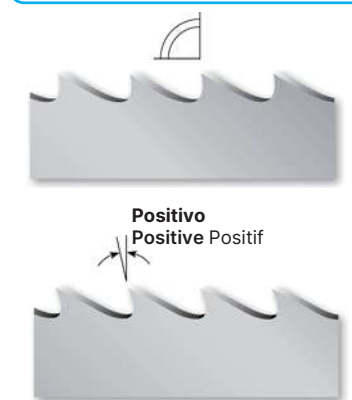

Ref. **4223**

HOJA DE SIERRA DE CINTA HSSE 8% Co IZARFLEX

IZARFLEX HSSE 8% Co Band Saw Blade

Lame de scie à ruban HSSE 8% Co IZARFLEX

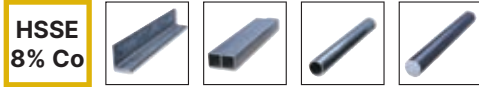
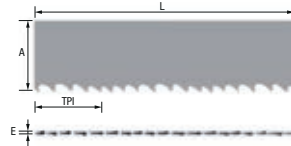

**HSSE
8% Co**

**Aceros
<850 N/mm²
Steel / Aciers**

**Aceros
<1000 N/mm²
Steel / Aciers**

**Cobre
Copper
Cuivre**

**Aluminio
Aluminium**

**Plásticos
Plastics
Plastiques**

Ideal para trabajos de taller exigentes, con los dientes de una calidad especial resistente al desgaste. Fleje flexible, bimetálico, combina dentados 0 y +

Ideal for heavy duty workshop cutting tasks, with special wear resistant quality teeth. Flexible strip, bimetal, 0 & + teeth combined.

Idéal pour des travaux d'atelier exigeants, avec dents d'une qualité spéciale résistante à l'usure. Feuillard Flexible, bimétal, possibilité dentures 0 et +

New!					New!					New!					New!									
L	A	E		€	L	A	E		€	L	A	E		€	L	A	E		€	L	A	E		€
mm	mm	mm	1 ud.		mm	mm	mm	1 ud.		mm	mm	mm	1 ud.		mm	mm	mm	1 ud.		mm	mm	mm	1 ud.	
1030	13	0,65	3		1710	13	0,65	3		3590	13	0,65	3		2370	20	0,90	2						
1080					1715					3600					2375									
1100					1718					3830					2380									
1104					1728					3857					2400									
1115					1730					4100					2450									
1125					1735					4180					2465									
1130					1740					4400					2470									
1138					1745					4440					2480									
1140					1750					4600					2490									
1147					1770					5140					2520									
1270					1790					1335	20	0,90	2		2530									
1300					1838					1350					2540									
1310					1840					1710					2542									
1325					1845					1735					2560									
1328					1875					1740					2600									
1330					2025					1750					2610									
1335					2100					2000					2625									
1340					2120					2005					2630									
1350					2125					2010					2650									
1365					2150					2020					2665									
1385					2230					2035					2700									
1400					2240					2037					2710									
1410					2242					2040					2750									
1425					2250					2058					2770									
1435					2290					2060					2950									
1440					2390					2065					2970									
1445					2440					2070					2980									
1450					2490					2075					3000									
1460					2500					2080					3084									
1470					2550					2085					3240									
1480					2560					2090					3280									
1490					2580					2095					3454									
1514					2650					2100					3900									
1525					2735					2110					3950									
1550					2750					2115					3960									
1575					2800					2120					4000									
1580					2840					2130					4185									
1600					2845					2140					4270									
1620					2890					2215					4400									
1630					2900					2225					4485									
1633					3115					2240					4665									
1635					3140					2265					4700									
1638					3160					2300					4900									
1640					3200					2350					5130									
1645					3355					2355					5800									
1650					3370					2360					7220									
1660					3420					2362					7320									
1680					3430					2365														



Ref. **4223**

HOJA DE SIERRA DE CINTA HSSE 8% Co IZARFLEX

IZARFLEX HSSE 8% Co Band Saw Blade

Lame de scie à ruban HSSE 8% Co IZARFLEX

New!

L mm	A mm	E mm		€ 1 ud.
2060	27	0,90	2	
2070				
2080				
2085				
2090				
2100				
2115				
2110				
2130				
2140				
2145				
2150				
2155				
2355				
2360				
2375				
2400				
2410				
2440				
2445				
2448				
2450				
2455				
2459				
2460				
2465				
2470				
2480				
2485				
2500				
2515				
2520				
2535				
2540				
2550				
2560				
2565				
2570				
2580				
2590				
2600				
2615				
2625				
2645				
2655				
2660				
2670				
2680				
2700				
2710				
2715				
2720				
2725				
2730				
2735				
2740				
2750				
2755				
2759				
2760				
2765				

New!

L mm	A mm	E mm		€ 1 ud.
2770	27	0,90	2	
2795				
2800				
2810				
2820				
2825				
2830				
2835				
2840				
2845				
2847				
2850				
2855				
2860				
2865				
2870				
2880				
2884				
2890				
2900				
2910				
2915				
2920				
2925				
2927				
2930				
2940				
2945				
2950				
2960				
2964				
2965				
2985				
3000				
3010				
3015				
3020				
3025				
3035				
3050				
3084				
3090				
3100				
3110				
3120				
3125				
3140				
3150				
3160				
3170				
3175				
3180				
3200				
3215				
3220				
3230				
3250				
3270				
3280				
3285				
3300				

New!

L mm	A mm	E mm		€ 1 ud.
3310	27	0,90	2	
3320				
3340				
3345				
3350				
3352				
3365				
3370				
3378				
3380				
3400				
3420				
3430				
3435				
3440				
3460				
3490				
3495				
3500				
3505				
3550				
3560				
3600				
3630				
3640				
3650				
3660				
3667				
3670				
3700				
3800				
3810				
3820				
3830				
3850				
3851				
3870				
3880				
3920				
4020				
4030				
4100				
4115				
4120				
4130				
4160				
4180				
4200				
4250				
4260				
4300				
4335				
4340				
4350				
4370				
4380				
4400				
4420				
4440				
4470				
4520				
4570				
4600				
4610				
4640				
4670				
4960				
5000				

New!

L mm	A mm	E mm		€ 1 ud.
5035	27	0,90	2	
5060				
5090				
5170				
5430				
5445				
5600				
5725				
6200				
6500				
7400				
2600	34	1,10	1	
2620				
2630				
2970				
3505				
3530				
3634				
3655				
3660				
3730				
3770				
3780				
3800				
3820				
3830				
3840				
3850				
3851				
3870				
3880				
3920				
4020				
4030				
4100				
4115				
4120				
4130				
4160				
4180				
4200				
4250				
4260				
4300				
4335				
4340				
4350				
4370				
4380				
4400				
4420				
4440				
4470				
4520				
4570				
4600				
4610				
4640				
4670				
4720				



Ref. **4223**

HOJA DE SIERRA DE CINTA HSSE 8% Co IZARFLEX

IZARFLEX HSSE 8% Co Band Saw Blade

Lame de scie à ruban HSSE 8% Co IZARFLEX

Cont.

New!

L mm	A mm	E mm		€ 1 ud.
4750	34	1,10	1	
4770				
4780				
4800				
4900				
4930				
4970				
4990				
5000				
5070				
5080				
5090				
5150				
5200				
5270				
5320				

New!

L mm	A mm	E mm		€ 1 ud.
5400	34	1,10	1	
5500				
5600				
5700				
5720				
5800				
6000				
6060				
6340				
6350				
6360				
7000				
7002				
7010				
8730				

New!

L mm	A mm	E mm		€ 1 ud.
4115	41	1,30	1	
4500				
4570				
4650				
4670				
4800				
4930				
5000				
5090				
5200				
5334				
5400				
5450				
5500				
5600				
5700				

New!

L mm	A mm	E mm		€ 1 ud.
5800	41	1,30	1	
5920				
5940				
6192				
6300				
6500				
6600				
6675				
6775				
6800				
6990				
7250				
7400				
7470				
7880				

Tipo Dentado (TZ) / Teeth Type (TZ) / Type Denture (TZ)

A x E	TPI									
	2	2-3	3	3-4	4	4-6	5-8	6-10	8-12	10-14
13 x 0,65								S	S	S
20 x 0,90										
27 x 0,90	K	K	K	K	K	K	S	S	S	S
34 x 1,10		K	K	K		K	S	S	S	
41 x 1,30		K		K		K				

Rollos sin Soldadura
Rolls without Welding
Rouleaux non soudées

L mm	A mm	E mm	8% Co €
30500	13	0,65	
100000	20	0,90	
100000	27	0,90	
100000	34	1,10	
75000	41	1,30	



Unidades pedido mínimo
Minimum order units
Unités commande minimale

Ejemplo Pedido / Order Example / Exemple Commande

Ref. 4223 + L 2450 + A 27 + E 0,90 + TPI 6-10 + TZ S



Ref. **4228**

HOJA DE SIERRA DE CINTA HSSE 8% Co + 4% Cr IZARPLUS

IZARPLUS HSSE 8% Co + 4% Cr Band Saw Blade

Lame de scie à ruban HSSE 8% Co + 4% Cr IZARPLUS

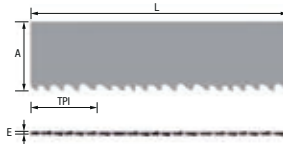

Aceros <850 N/mm ² Steel / Aciers	Aceros <1000 N/mm ² Steel / Aciers	Fundición Cast Iron Fonte	INOX Stainless Steel Acier INOX
Cobre Copper Cuivre	Aluminio Aluminium	Plásticos Plastics Plastiques	

Especial Perfiles. Dentado variable 0° adecuado para perfiles y tareas de corte en serie, susceptibles de vibraciones.

Special Profiles. Variable tooth pitch 0° for profiles and bundle sawing tasks, susceptible of vibrations.

Spécial profils. Denture variable 0° convenable pour profils et travaux de coupe en paquet, susceptibles des vibrations.

New!

New!

New!

New!

L mm	A mm	E mm		€ 1 ud.
1100	13	0,65	3	
1130				
1138				
1140				
1300				
1310				
1325				
1330				
1335				
1340				
1350				
1368				
1400				
1425				
1430				
1435				
1440				
1450				
1460				
1470				
1500				
1550				
1575				
1580				
1605				
1620				
1635				
1638				
1640				
1645				
1650				
1680				
1730				
1732				
1735				
1740				
1750				
1974				
2180				
2240				
2265				
2900				
3700				
3800				
3825				
4180				

L mm	A mm	E mm		€ 1 ud.
1125	13	0,90	3	
1140				
1325				
1330				
1335				
1338				
1375				
1440				
1450				
1470				
1485				
1638				
1640				
1650				
1735				
1750				
1840				
2240				
4450				

L mm	A mm	E mm		€ 1 ud.
1735	20	0,90	2	
2000				
2010				
2035				
2045				
2060				
2070				
2080				
2082				
2085				
2090				
2100				
2110				
2130				
2140				
2150				
2265				
2360				
2362				
2370				
2375				
2400				
2450				
2465				
2480				
2500				
2520				
2530				
2600				
2825				
2960				
2970				
2980				
3000				

L mm	A mm	E mm		€ 1 ud.
2080	27	0,90	2	
2100				
2110				
2145				
2150				
2190				
2360				
2375				
2400				
2430				
2435				
2440				
2445				
2450				
2455				
2460				
2470				
2480				
2490				
2500				
2520				
2535				
2550				
2560				
2565				
2570				
2600				
2640				
2655				
2660				
2680				
2700				
2710				
2715				
2720				
2730				
2740				
2745				
2750				
2755				
2760				
2765				
2780				
2800				
2805				



Ref. **4228**

HOJA DE SIERRA DE CINTA HSSE 8% Co + 4% Cr IZARPLUS

IZARPLUS HSSE 8% Co + 4% Cr Band Saw Blade

Lame de scie à ruban HSSE 8% Co + 4% Cr IZARPLUS

Cont.

New!

L mm	A mm	E mm		€ 1 ud.
2820	27	0,90	2	
2825				
2830				
2835				
2840				
2845				
2850				
2860				
2865				
2870				
2885				
2900				
2910				
2920				
2925				
2927				
2930				
2950				
2965				
3000				
3010				
3025				
3035				
3080				
3090				
3100				
3110				
3120				
3135				
3140				
3150				
3160				
3180				
3200				
3270				
3300				
3320				
3335				
3340				

New!

L mm	A mm	E mm		€ 1 ud.
3345	27	0,90	2	
3350				
3352				
3370				
3400				
3420				
3440				
3454				
3485				
3505				
3560				
3630				
3650				
3660				
3670				
3684				
3800				
3810				
3820				
3830				
3835				
3850				
3851				
3857				
3900				
3930				
4090				
4115				
4160				
4230				
4250				
4280				
4500				
4600				
4820				
4870				
4880				
5030				
5200				

New!

L mm	A mm	E mm		€ 1 ud.
3320	34	1,10	1	
3505				
3660				
3730				
3770				
3800				
3820				
3860				
3910				
3920				
3950				
4020				
4030				
4100				
4120				
4160				
4250				
4335				
4380				
4400				
4420				
4450				
4470				
4500				
4520				
4570				
4610				
4620				
4640				
4780				
4800				
4930				
4970				
4990				
5030				
5040				

New!

L mm	A mm	E mm		€ 1 ud.
5050	34	1,10	1	
5080				
5090				
5200				
5270				
5300				
6350				
6500				
6550				
7000				
7550				
8730				
4115	41	1,30	1	
4500				
4640				
4930				
5000				
5040				
5090				
5265				
5300				
5340				
5350				
5450				
5700				
5920				
6175				
6300				
6400				
6585				
6650				
6775				
6800				
6900				
7470				
7880				
8200				

Tipo Dentado (TZ) / Teeth Type (TZ) / Type Denture (TZ)

A x E	TPI					
	3-4	4-6	5-8	6-10	8-12	10-14
13 x 0,65				S	S	S
13 x 0,90				S	S	S
20 x 0,90		S	S	S	S	S
27 x 0,90	S	S	S	S	S	S
34 x 1,10	S	S	S	S	S	
41 x 1,30	S	S	S	S		

Rollos sin Soldadura / Rolls without Welding / Rouleaux non soudées

L mm	A mm	E mm	8% Co €	L mm	A mm	E mm	8% Co €
30500	13	0,65		100000	27	0,90	
123000				134000			
30500	13	0,90		100000	34	1,10	
100000	20	0,90		75000	41	1,30	



Unidades pedido mínimo
Minimum order units
Unités commande minimale

Ejemplo Pedido / Order Example / Exemple Commande

Ref. 4228 + L 2080 + A 27 + E 0,90 + TPI 8-12 + TZ S



Ref. **4229**

HOJA DE SIERRA DE CINTA HSSE 8% Co + 4% Cr IZARPLUS

IZARPLUS HSSE 8% Co + 4% Cr Band Saw Blade

Lame de scie à ruban HSSE 8% Co + 4% Cr IZARPLUS

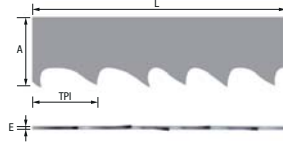

Aceros
<850 N/mm²
Steel / Aciers

Aceros
<1000 N/mm²
Steel / Aciers

INOX
Stainless Steel
Acier INOX

Cobre
Copper
Cuivre

Aluminio
Aluminium

Plásticos
Plastics
Plastiques

HSSE
8% Co

4% Cr



Especial Macizos. Dentado variable 10°. Mayores rendimientos de corte, ideal para el corte de piezas macizas grandes.

Special Solid Pieces. Variable tooth pitch 10°. Higher cutting performance, suitable to cut big solid pieces.

Spécial pièces pleins. Denture variable 10°. Rendements de coupe supérieurs, convenable pour la coupe de grandes pièces pleins.

New!

L mm	A mm	E mm		€ 1 ud.
2080	27	0,90	2	
2150				
2450				
2455				
2459				
2460				
2480				
2550				
2565				
2570				
2590				
2600				
2680				
2700				
2710				
2720				
2730				
2740				
2750				
2755				
2760				
2765				
2800				
2825				
2835				
2845				
2855				
2910				
2925				
2950				
3000				
3010				
3025				
3035				
3100				
3105				
3120				

New!

L mm	A mm	E mm		€ 1 ud.
3140	27	0,90	2	
3150				
3160				
3180				
3200				
3222				
3240				
3270				
3300				
3320				
3345				
3350				
3352				
3400				
3420				
3445				
3495				
3500				
3505				
3520				
3550				
3640				
3660				
3770				
3800				
3810				
3820				
3830				
3900				
3930				
4090				
4110				
4115				
4310				
4500				
4640				
4800				

New!

L mm	A mm	E mm		€ 1 ud.
3350	34	1,10	1	
3505				
3770				
3820				
3850				
4020				
4100				
4115				
4120				
4130				
4160				
4210				
4220				
4250				
4335				
4420				
4440				
4450				
4470				
4500				
4520				
4530				
4570				
4640				
4720				
4770				
4780				
4860				
4865				
4970				
4990				
5000				
5090				
5156				
5200				
5270				
5300				

New!

L mm	A mm	E mm		€ 1 ud.
4115	41	1,30	1	
4500				
4640				
4650				
4700				
4900				
4930				
5000				
5040				
5080				
5090				
5340				
5350				
5450				
5800				
5890				
5920				
6040				
6300				
6500				
6585				
6675				
6775				
6800				
6900				
7470				
8200				
8400				
5800	54	1,60	1	
6040				
6096				
6200				
6270				
6500				
7140				
7200				
7310				
7450				
7460				
7545				
7600				
8900				
9750				

Tipo Dentado (TZ)
Teeth Type (TZ) / Type Denture (TZ)

A x E	TPI				
	1,4-2	2-3	3-4	4-6	5-8
27 x 0,90		K	K	K	K
34 x 1,10	K	K	K	K	K
41 x 1,30	K	K	K	K	K
54 x 1,60	K	K	K	K	



Unidades pedido mínimo
Minimum order units
Unités commande minimale

Rolls sin Soldadura
Rolls without Welding - Rouleaux non soudées

L mm	A mm	E mm	8% Co €
100000	20	0,90	
100000	27	0,90	
134000			
100000	34	1,10	
75000	41	1,30	

Ejemplo Pedido / Order Example / Exemple Commande **Ref. 4229 + L 2080 + A 27 + E 0,90 + TPI 5-8 + TZ K**



Ref. **1994**

ARCO SIERRA
Hacksaw Frame
Monture scie

¡Hoja de Sierra de Regalo!
Free Hacksaw Blade!
Lame scie **cadeau!**



Arco ergonómico de aleación de aluminio. Corte recto, vertical y horizontal. Hoja sierra regalo art. 67592: TPI 24

Ergonomic Aluminium alloyed hack saw frame. Straight cut, both vertical and horizontal. Free hacksaw blade art. 67592: TPI 24

Monture ergonomique de alliage aluminium. Coupe droite et horizontale. Lame scie cadeau art. 67592 : TPI 24



Nº Art.	€
62289	



Ref. **1999**

HOJA SIERRA
Hacksaw Blade
Lame scie

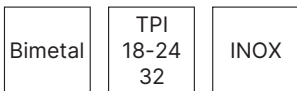

Aceros <850 N/mm² Steel / Aciers
Aceros <1000 N/mm² Steel / Aciers
INOX Stainless Steel Acier INOX

New!

TPI	L mm	Cube	Nº Art.	€ 1 ud.
18	300	20	48809	
18	300	100	13856	
24	300	20	25355	
24	300	100	25387	
32	300	100	28767	



Ref. **1997**

HOJA SIERRA
Hacksaw Blade
Lame scie

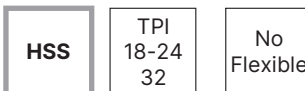

Aceros <850 N/mm² Steel / Aciers
Aceros <1000 N/mm² Steel / Aciers

TPI	L mm	Cube	Nº Art.	€ 1 ud.
18	300	20	48806	
18	300	100	34553	
24	300	20	34552	
24	300	100	34554	
32	300	100	34555	

* Ref. 1997 hasta fin de existencias
while stock lasts / jusqu'à la fin de stock



Ref. **1996**

HOJA SIERRA
Hacksaw Blade
Lame scie



Mod. 1



Mod. 2



Mod.	Usos / Use / Usage	TPI	L mm	Cube	Nº Art.	€ 1 ud.
1	Metal	24	300	50	17139	
2	Metal-Madera/Wood/Bois	24	300	50	67592	



HERRAMIENTAS TORNEADO

Brazed Turning Tools

Outils de tour

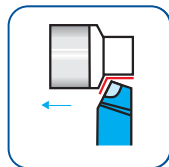
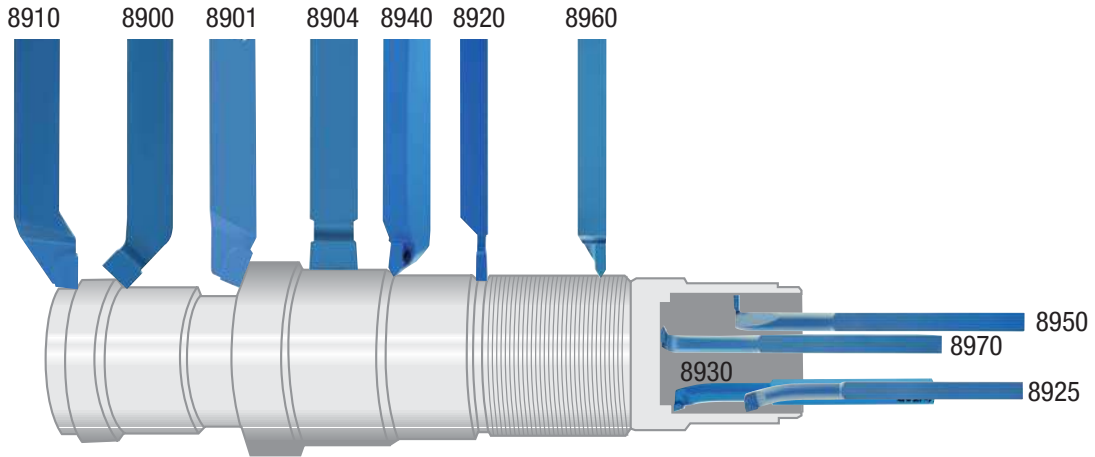

ISO 1 - 8901

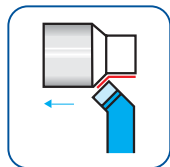

ISO 2 - 8900

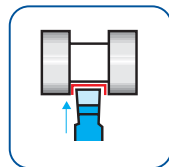

ISO 4 - 8904

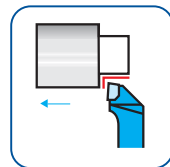

ISO 6 - 8910

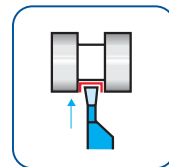

ISO 7 - 8920

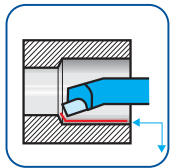

ISO 8 - 8925

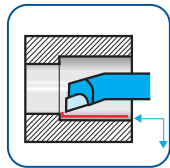

ISO 9 - 8930

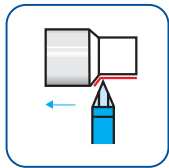

ISO 10 - 8940

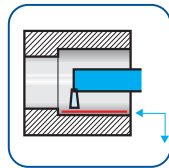

ISO 11 - 8950

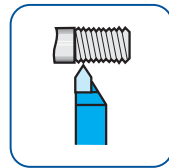

ISO 12 - 8960

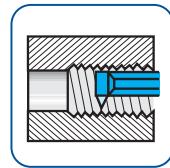

ISO 13 - 8970

Calidad P20

Especialmente destinada a mecanizados de gran precisión y semi-acabado en aceros al carbono y aleados, a grandes velocidades de corte y avances moderados.

P20 Quality

Specially destined for high precision and semi-finishing machining of carbon & alloy steels, at high cutting speeds and moderate feeds.

Qualité P20

Notamment pour usinages haute précision et semi-finition en aciers au carbone et alliés, a hautes vitesses de coupe et avances modérés.

Calidad M20

Especial para acabado y desbaste suave de aceros, aceros al manganeso, fundición y metales resistentes al calor o no ferrosos, a velocidades de corte medias o bajas.

M20 Quality

Special for finishing and soft roughing of steels, manganese-steels, cast iron and heat-resistant or non-ferrous materials, at medium or low cutting speed.

Qualité M20

Spécial finition et ébauche tendre d'aciers, aciers au manganèse, fonte et aciers résistants au chaud et non ferreux à faibles où moyennes vitesses de coupe.

Calidad K10

Especial para mecanizados de gran precisión y semi-acabado en fundición, aceros aleados, materiales de viruta corta y no ferrosos.

K10 Quality

Special for high precision and semi-finishing machining of cast iron, alloyed steels, short chipping and non-ferrous materials.

Qualité K10

Spéciale pour usinage d'haute précision et semi-finition fonte, alliages aciers, aciers copeaux courts et non ferreux.

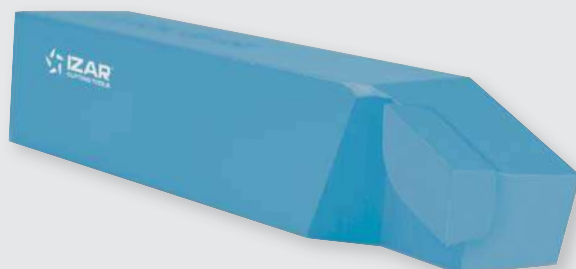

Ref. **8901**

HERRAMIENTA TORNEADO PLACA SOLDADA CILINDRADO 70°

70° Straight Brazed Turning Tool

Outil de tour plaquette soudé cylindrage 70°

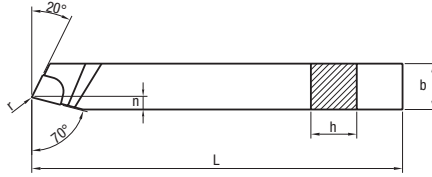

Aceros <850 N/mm ² Steel / Aciers	Aceros <1000 N/mm ² Steel / Aciers	Fundición Cast Iron Fonte
Aceros <1300 N/mm ² Steel / Aciers	INOX Stainless Steel Acier INOX	Cobre Copper Cuivre
Fundición Cast Iron Fonte		Aluminio Aluminium

h mm	b mm	L mm	R/L	n mm	r mm	Calidad Quality / Qualité P-20		Calidad Quality / Qualité K-10	
						N° Art.	€	N° Art.	€
10	x 10	x 90	- L	4	0,2	55888		55889	
10	x 10	x 90	- R	4	0,2	55893		55891	
12	x 12	x 100	- L	5	0,4	55894		55897	
12	x 12	x 100	- R	5	0,4	55896		55899	
16	x 16	x 110	- L	6	0,4	55903		55905	
16	x 16	x 110	- R	6	0,4	55904		55906	
20	x 20	x 125	- L	8	0,8	55911		55913	
20	x 20	x 125	- R	8	0,8	55912		55914	
25	x 25	x 140	- L	10	0,8	55917		55919	
25	x 25	x 140	- R	10	0,8	55918		55920	



Ref. **8900**

HERRAMIENTA TORNEADO PLACA SOLDADA ESCUADRADO 45°

45° Bent Brazed Turning Tool

Outil de tour plaquette soudé décolletage 45°

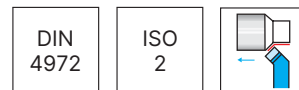
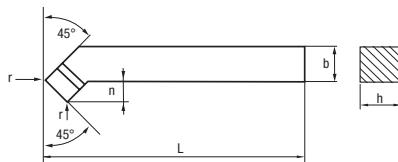
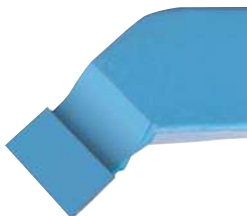

Aceros <850 N/mm ² Steel / Aciers	Aceros <1000 N/mm ² Steel / Aciers	Fundición Cast Iron Fonte
Aceros <1300 N/mm ² Steel / Aciers	INOX Stainless Steel Acier INOX	Cobre Copper Cuivre
Fundición Cast Iron Fonte	INOX Stainless Steel Acier INOX	Aluminio Aluminium

h mm	b mm	L mm	R/L	n mm	r mm	Calidad Quality / Qualité P-20		Calidad Quality / Qualité M-20		Calidad Quality / Qualité K-10	
						N° Art.	€	N° Art.	€	N° Art.	€
12	x 12	x 100	- L	7	0,4	13586		56073		29179	
12	x 12	x 100	- R	7	0,4	13585		56074		29153	
16	x 16	x 110	- L	8	0,4	13589		56076		29181	
16	x 16	x 110	- R	8	0,4	13588		56077		18258	
20	x 20	x 125	- L	10	0,8	13592		56078		13051	
20	x 20	x 125	- R	10	0,8	13591		56079		28343	
25	x 25	x 140	- L	12	0,8	13597		56080		29182	
25	x 25	x 140	- R	12	0,8	13594		56082		26003	



Ref. **8904**

HERRAMIENTA TORNEADO PLACA SOLDADA RANURADO EXTERIOR

Wide Face Square Nose Brazed Turning Tool
Outil de tour plaquette soudé rainurage extérieur

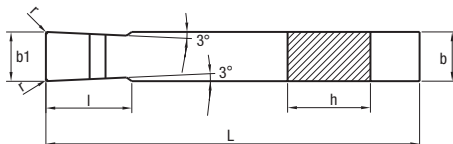

DIN
4976

ISO
4



Aceros <850 N/mm ² Steel / Aciers	Aceros <1000 N/mm ² Steel / Aciers
Aceros <1300 N/mm ² Steel / Aciers	INOX Stainless Steel Acier INOX
Fundición Cast Iron Fonte	

Fundición Cast Iron Fonte
Cobre Copper Cuivre
Aluminio Aluminium

h mm	b mm	L mm	r mm	l mm	b1 mm	Calidad Quality / Qualité P-20	Calidad Quality / Qualité K-10		
						N° Art.	€	N° Art.	€
20	12	125	0,4	20	12	55924	55926		
25	16	140	0,4	25	16	55928	55932		
32	20	170	0,4	32	20	55936	55938		



Ref. **8910**

HERRAMIENTA TORNEADO PLACA SOLDADA ESCUADRADO 90°

90° Offset Side Brazed Turning Tool
Outil de tour plaquette soudé décolletage 90°

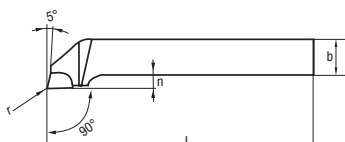

DIN
4980

ISO
6



Aceros <850 N/mm ² Steel / Aciers	Aceros <1000 N/mm ² Steel / Aciers
Aceros <1300 N/mm ² Steel / Aciers	INOX Stainless Steel Acier INOX
Fundición Cast Iron Fonte	

INOX
Stainless Steel
Acier INOX

Fundición Cast Iron Fonte
Cobre Copper Cuivre
Aluminio Aluminium

h mm	b mm	L mm	R/L	n mm	r mm	Calidad Quality / Qualité P-20	Calidad Quality / Qualité M-20	Calidad Quality / Qualité K-10			
						N° Art.	€	N° Art.	€	N° Art.	€
10	10	090	- L	4	0,2	13601	56083	29183			
10	10	090	- R	4	0,2	13600	56085	26488			
12	12	100	- L	5	0,4	13604	56086	29185			
12	12	100	- R	5	0,4	13603	56088	26707			
16	16	110	- L	6	0,4	13607	56089	13058			
16	16	110	- R	6	0,4	13606	56091	27460			
20	20	125	- L	8	0,8	13612	56092	10825			
20	20	125	- R	8	0,8	13609	56093	27461			
25	25	140	- L	10	0,8	13616	56094	17090			
25	25	140	- R	10	0,8	13615	56095	11181			



Ref. **8920**

HERRAMIENTA TORNEADO PLACA SOLDADA TRONZADO

Parting Brazed Turning Tool
Outil de tour plaquette soudé tronçonnage

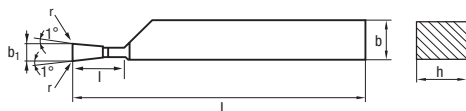

DIN
4981

ISO
7



Aceros <850 N/mm ² Steel / Aciers	Aceros <1000 N/mm ² Steel / Aciers
Aceros <1300 N/mm ² Steel / Aciers	INOX Stainless Steel Acier INOX
Fundición Cast Iron Fonte	

INOX
Stainless Steel
Acier INOX

Fundición
Cast Iron
Fonte

Cobre
Copper
Cuivre

Aluminio
Aluminium



h mm	b mm	L mm	R/L	r mm	l mm	b1 mm	Calidad Quality / Qualité P-20	Calidad Quality / Qualité M-20	Calidad Quality / Qualité K-10			
							N° Art.	€	N° Art.	€	N° Art.	€
12	8	100	- L	0,2	12	3	13619		28344			
12	8	100	- R	0,2	12	3	13618	56098	27519			
16	10	110	- L	0,2	14	4	13622		29186			
16	10	110	- R	0,2	14	4	13621	56100	19523			
20	12	125	- L	0,2	16	5	13625		29187			
20	12	125	- R	0,2	16	5	13624	56102	22685			
25	16	140	- L	0,3	20	6	13628		29189			
25	16	140	- R	0,3	20	6	13627	56104	29188			

Ref. **8925**

HERRAMIENTA TORNEADO PLACA SOLDADA MANDRINADO

Boring Straight Brazed Turning Tool
Outil de tour plaquette soudé alésage

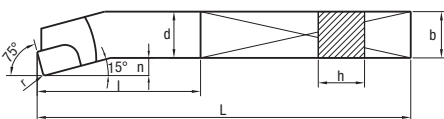

DIN
4973

ISO
8

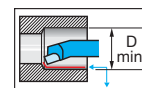

Aceros <850 N/mm ² Steel / Aciers	Aceros <1000 N/mm ² Steel / Aciers
Aceros <1300 N/mm ² Steel / Aciers	INOX Stainless Steel Acier INOX
Fundición Cast Iron Fonte	

Fundición
Cast Iron
Fonte

Cobre
Copper
Cuivre

Aluminio
Aluminium

h mm	b mm	L mm	n mm	r mm	D min. mm	Calidad Quality / Qualité P-20	Calidad Quality / Qualité K-10		
						N° Art.	€	N° Art.	€
8	8	125	3	0,4	14	38218	38220		
10	10	150	4	0,4	18	38222	38224		
12	12	180	5	0,4	21	38227	38391		
16	16	210	6	0,4	27	38393	38395		
20	20	250	8	0,4	34	38397	38399		
25	25	300	10	0,8	43	38401	38403		



Ref. **8930**

HERRAMIENTA TORNEADO PLACA SOLDADA CILINDRADO INTERIOR

Internal Sharped Brazed Turning Tool

Outil de tour plaquette soudé cylindrage intérieur

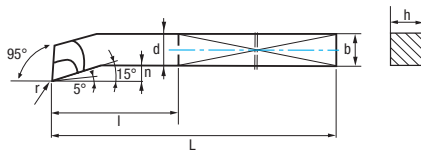

DIN
4974

ISO
9

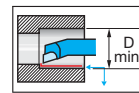

Aceros <850 N/mm ² Steel / Aciers	Aceros <1000 N/mm ² Steel / Aciers
Aceros <1300 N/mm ² Steel / Aciers	INOX Stainless Steel Acier INOX
Fundición Cast Iron Fonte	

INOX
Stainless Steel
Acier INOX

Fundición
Cast Iron
Fonte

Cobre
Copper
Cuivre

Aluminio
Aluminium

h mm	b mm	L mm	d mm	n mm	r mm	l mm	D min. mm	Calidad Quality / Qualité P-20		Calidad Quality / Qualité M-20		Calidad Quality / Qualité K-10	
								N° Art.	€	N° Art.	€	N° Art.	€
8	x 8	x 125	8	3	0,2	40	14	13630		56114		14971	
10	x 10	x 150	10	4	0,2	50	18	13631		56115		27462	
12	x 12	x 180	12	5	0,2	63	21	13633		56116		27464	
16	x 16	x 210	16	6	0,2	80	27	13634		56117		11152	
20	x 20	x 250	20	8	0,4	100	34	13636		56118		11754	
25	x 25	x 300	25	10	0,4	125	43	13639		56119		27518	
32	x 32	x 355	32	12	0,8	160	52	13642		56121		13896	

Ref. **8940**

HERRAMIENTA TORNEADO PLACA SOLDADA CILINDRADO RECTO

Sharped Straight Brazed Turning Tool

Outil de tour plaquette soudé cylindrage droit



DIN
4975

ISO
10



Aceros <850 N/mm ² Steel / Aciers	Aceros <1000 N/mm ² Steel / Aciers
Aceros <1300 N/mm ² Steel / Aciers	INOX Stainless Steel Acier INOX
Fundición Cast Iron Fonte	

Fundición
Cast Iron
Fonte

Cobre
Copper
Cuivre

Aluminio
Aluminium

h mm	b mm	L mm	r mm	Calidad Quality / Qualité P-20		Calidad Quality / Qualité K-10	
				N° Art.	€	N° Art.	€
16	x 10	x 110	0,2	13645		29190	
20	x 12	x 125	0,4	13646		29191	
25	x 16	x 140	0,4	13648		29192	



Ref. **8950**

HERRAMIENTA TORNEADO PLACA SOLDADA RANURADO INTERIOR

Internal Undercutting Brazed Turning Tool

Outil de tour plaquette soudé rainurage intérieur

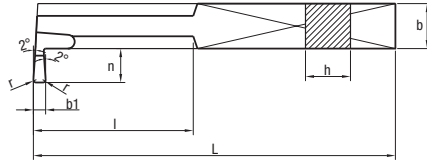

DIN
263

ISO
11

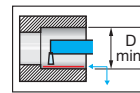

Aceros <850 N/mm ² Steel / Aciers	Aceros <1000 N/mm ² Steel / Aciers	Fundición Cast Iron Fonte
Aceros <1300 N/mm ² Steel / Aciers	INOX Stainless Steel Acier INOX	Cobre Copper Cuivre
Fundición Cast Iron Fonte		Aluminio Aluminium

h mm	b mm	L mm	n mm	r mm	b1 mm	D min. mm	Calidad Quality / Qualité P-20		Calidad Quality / Qualité K-10	
							N° Art.	€	N° Art.	€
12	12	180	10	0,2	4	32	38405		38407	
16	16	210	12	0,2	5	40	38409		38411	
20	20	250	16	0,4	6	50	38413		38415	
25	25	300	20	0,4	8	63	38417		38419	



Ref. **8960**

HERRAMIENTA TORNEADO PLACA SOLDADA ROSCADO EXTERIOR

External Threading Brazed Turning Tool

Outil de tour plaquette soudé taraudage extérieur



DIN
282

ISO
12



Aceros <850 N/mm ² Steel / Aciers	Aceros <1000 N/mm ² Steel / Aciers	Fundición Cast Iron Fonte
Aceros <1300 N/mm ² Steel / Aciers	INOX Stainless Steel Acier INOX	Cobre Copper Cuivre
Fundición Cast Iron Fonte		Aluminio Aluminium

h mm	b mm	L mm	R/L	n mm	Calidad Quality / Qualité P-20		Calidad Quality / Qualité K-10	
					N° Art.	€	N° Art.	€
16	10	110	- L	2,0	38422		38424	
16	10	110	- R	2,0	38421		38423	
20	12	125	- L	2,5	38426		38428	
20	12	125	- R	2,5	38425		38427	
25	16	140	- L	3,0	38430		38432	
25	16	140	- R	3,0	38429		38431	



Ref. **8970**

HERRAMIENTA TORNEADO PLACA SOLDADA ROSCADO INTERIOR

Internal Threading Brazed Turning Tool

Outil de tour plaquette soudé taraudage intérieur

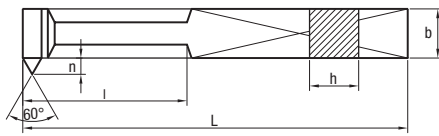

DIN
283

ISO
13

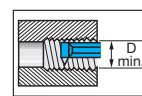

Aceros <850 N/mm ² Steel / Aciers	Aceros <1000 N/mm ² Steel / Aciers	Fundición Cast Iron Fonte
Aceros <1300 N/mm ² Steel / Aciers	INOX Stainless Steel Acier INOX	Cobre Copper Cuivre
Fundición Cast Iron Fonte		Aluminio Aluminium

h mm	b mm	L mm	R/L	n mm	D min. mm	Calidad Quality / Qualité P-20		Calidad Quality / Qualité K-10	
						N° Art.	€	N° Art.	€
10	x 10	x 150	- L	5	22	38434		38436	
10	x 10	x 150	- R	5	22	38433		38435	
12	x 12	x 180	- L	6	24	38438		38440	
12	x 12	x 180	- R	6	24	38437		38439	
16	x 16	x 210	- L	8	32	38442		38444	
16	x 16	x 210	- R	8	32	38441		38443	
20	x 20	x 250	- L	10	40	38446		38448	
20	x 20	x 250	- R	10	40	38445		38447	
25	x 25	x 300	- L	12	49	38450		38452	
25	x 25	x 300	- R	12	49	38449		38451	

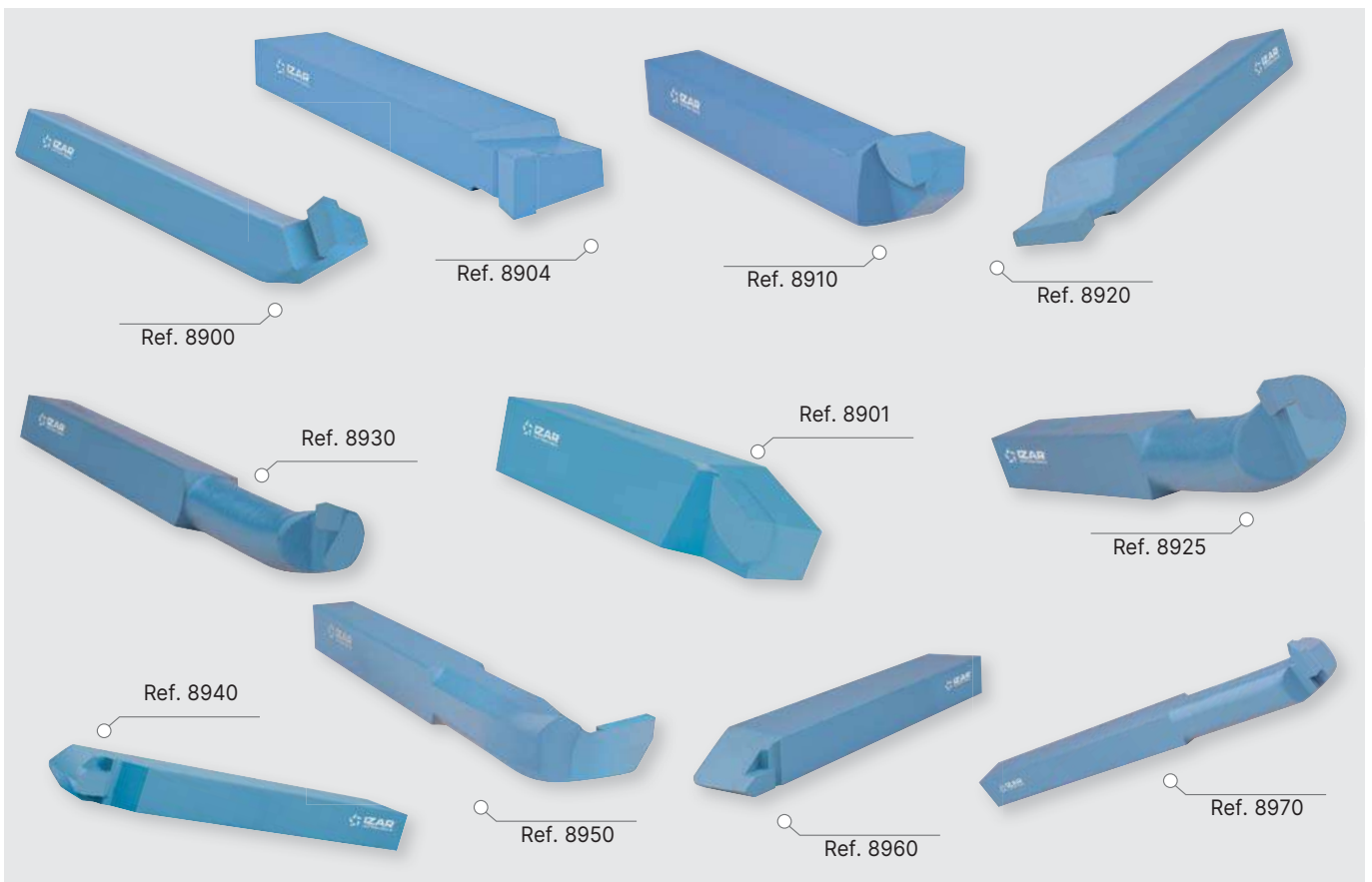

Ref. **8990**

CUCHILLA CUADRADA TORNEADO

Square Turning Blade
Outil de tour carré

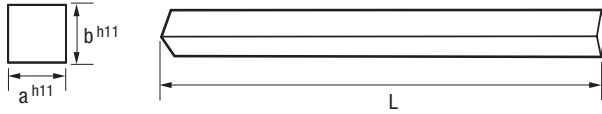

Cuchillas Torno
Turning Tools
Outils de tour

HSSE
10% Co

DIN
4964B



a mm	b mm	L mm	Nº Art.	€
6	6	100	35462	
6	6	160	35463	
6	6	200	35464	
8	8	100	35465	
8	8	160	35466	
8	8	200	35467	
10	10	100	35468	
10	10	160	35469	
10	10	200	35470	
12	12	100	35471	
12	12	160	35472	
12	12	200	35473	
14	14	200	35474	
16	16	200	35475	
18	18	200	35476	
20	20	200	35477	
25	25	200	35478	



Ref. **8991**

CUCHILLA REDONDA TORNEADO

Round Turning Blade
Outil de tour rond

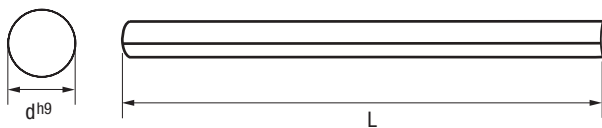

Cuchillas Torno
Turning Tools
Outils de tour

HSSE
10% Co

DIN
4964A



d mm	L mm	Nº Art.	€
4	100	35479	
5	100	35480	
5	200	35481	
6	100	35482	
6	160	35484	
6	200	35483	
8	100	35485	
8	160	35486	
8	200	35487	
10	100	35488	
10	160	35489	
10	200	35490	
12	100	35491	
12	200	35492	
14	200	35493	
16	200	35494	
18	200	35495	
20	200	35497	



Ref. **8992**

CUCHILLA TRAPEZOIDAL TORNEADO

Trapezoidal Turning Blade
Outil de tour trapézoïdal



HSSE
10% Co

DIN
4964E

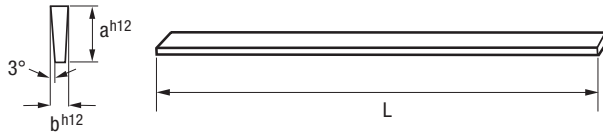

a mm	b mm	L mm	N° Art.	€
10	2,50	100	13690	
12	3,00	100	13691	
12	3,00	160	13693	
16	4,00	100	13782	
16	4,00	160	13786	
20	5,00	160	13787	
20	5,00	200	14213	
25	6,00	160	14225	

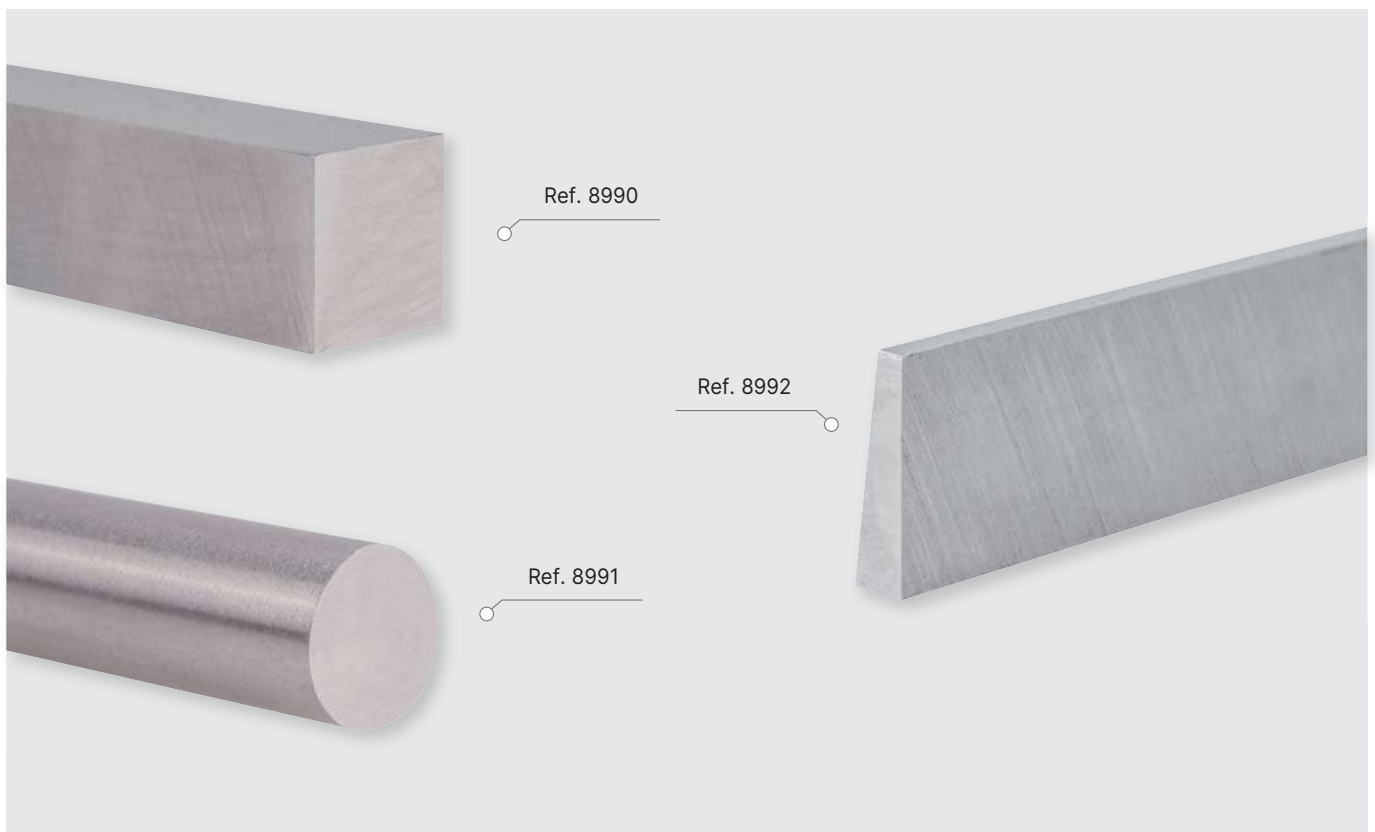

Ref. **8301**

GRANETE
Centre Punch
Pointeau à marquer



Ref. 8301
Hasta fin de existencias
While stock lasts
Jusqu'à la fin de stock

D mm	d mm	L mm		Nº Art.	€ 1 ud.
2	9	130	10	13302	
8	11	160	10	13307	



Ref. **8302**

BOTADOR CÓNICO
Taper Punch
Poinçon conique



Ref. 8302
Hasta fin de existencias
While stock lasts
Jusqu'à la fin de stock

D mm	d mm	L mm		Nº Art.	€ 1 ud.
2	9	130	10	13308	
4	9	130	10	13309	
5	9	130	10	13310	
6	11	160	10	13311	
8	11	160	10	13312	
10	11	160	10	13313	



Ref. **8303**

BOTADOR CILÍNDRICO
Parallel Punch
Poinçon cylindrique



Ref. 8303
Hasta fin de existencias
While stock lasts
Jusqu'à la fin de stock

D mm	d mm	L mm		Nº Art.	€ 1 ud.
5	11	160	10	13316	
7	11	160	10	13324	
9	11	160	10	13916	
10	11	160	10	13917	



Ref. **8304**

CINCEL Y BURIL
Cold & Cape Chisel
Ciseau et burin



Ref. 8304
Hasta fin de existencias
While stock lasts
Jusqu'à la fin de stock

Tipo Type Type	D mm	d mm	L mm		Nº Art.	€ 1 ud.
Cinzel Cold Chisel Ciseau	12	9,5	13	10	13918	
Buril Cape Chisel Burin	5	9,5	13	10	13920	



Ref. **8310**

SETS GRANETES, BOTADORES, CINCELES Y BURILES

Punches and Chisels Sets

Sets pointeaux, poinçons, ciseaux et burins

Ref. 8310

Hasta fin de existencias / while stock lasts / jusqu'à la fin de stock



Mod. 1

6 Pcs



Cont. Ref.	Cont. Descrip.	Nº Art.	€
8304 8302 8301	Buril, Cíncel, Cónicos 2-4, Granetes 4-6 Cold & Cape Chisel, Taper 2-4 & Centre Punch. 4-6 Burin, Ciseau, Coniques 2-4, Pointeaux 4-6	13921	

Mod. 2

6 Pcs



Cont. Ref.	Cont. Descrip.	Nº Art.	€
8304 8302 8301 8303	Buril, Cíncel, Cónico 4, Granete 4, Cilíndricos 4-8 Cold & Cape Chisel, Taper 4, Centre 4 & Parallel 4-8 Burin, Ciseau, Conique 4, Pointeau 4, Cylíndricas 4-8	13923	

Mod. 3

6 Pcs



Cont. Ref.	Cont. Descrip.	Nº Art.	€
8304 8301	Buril, Cíncel, Granetes 2-4-6-8 Cold & Cape Chisel, Centre Punches 2-4-6-8 Burin, Ciseau, Pointeaux 2-4-6-8	13924	

Mod. 4

6 Pcs



Cont. Ref.	Cont. Descrip.	Nº Art.	€
8302	Cónicos 2-4-5-6-8-10 Taper Punches 2-4-5-6-8-10 Coniques 2-4-5-6-8-10	13926	

Mod. 6

6 Pcs



Cont. Ref.	Cont. Descrip.	Nº Art.	€
8303	Cilíndricos 5-6-7-8-9-10 Parallel Punches 5-6-7-8-9-10 Cylíndricas 5-6-7-8-9-10	13928	



Ref. **8352**

REBARBADOR EXTERIOR

External Chamfer Tool
Outil de chanfrein externe

New!

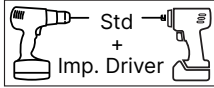
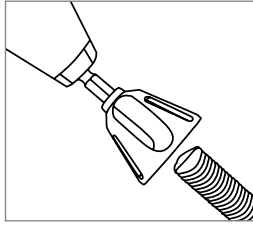

Cuchillas de Metal Duro de alta calidad
High performance Carbide Blades
Lames carbure haute qualité

Aceros
<850 N/mm²
Steel / Aciers

Fundición
Cast Iron
Fonte

Cobre
Copper
Cuivre

Latón
Brass
Laiton

Aluminio
Aluminium

Cap.	Nº Art.	€
Ø 6 - 25 mm	25381	



Video



Ref. **8351**

ACCESORIOS REBARBADORES

Deburring Tool Accessories
Accessoires ébavureurs



Mango / Shank / Queue

Medida Size - Dimension		Nº Art.	€
00001	1	12834	



Porta **Universal** Holder

Medida Size - Dimension		Nº Art.	€
00006UNI	1	76576	



Cuchillas Blades Lames	Material Materiel		Nº Art.	€ pack
B10	HSS	10	12825	
B20	HSS	10	12827	





Cuchillas Blades Lames	Material Materiel		Nº Art.	€ pack
E100	HSS	10	12829	
E100S	HSSE	10	12830	
E200	HSS	10	12831	
E300	HSS	10	12833	



ACCESORIOS REBARBADORES

Deburring Tool Accessories

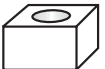
Accessoires ébavureurs

Aplicación Application Application	Material Material Materiel	Aceros <850 N/mm² Steel / Aciers		Cobre Copper Cuivre		Latón Brass Laiton		Aluminio Aluminium		Fundición Cast Iron Fonte		INOX Stainless Steel Acier INOX		Plásticos Plastics Plastiques	
Bordes rectos Straight Edges Bouts droits		B10 E100 E100S	B20 E200	E100S	B10 E100 E100S B20 E200										
Bordes de Agujeros Hole Edges Bouts de trous															
Bordes Agujeros Pasantes Through Hole Edges Bouts de trous débouchants		E300			E300										

Ref. **8350**

JUEGO REBARBADORES

Deburring Tool Sets
Jeux ébavureurs



MOD. B



Juego
Mod. B
Set



Aceros
<850 N/mm²
Steel / Aciers

Fundición
Cast Iron
Fonte

Cobre
Copper
Cuivre

Latón
Brass
Laiton

Aluminio
Aluminium

Plásticos
Plastics
Plastiques



+



4 Pcs

Cont.	Nº Art.	€
Mango / Shank / Queue Porta Universal Holder B10 / B20	12816	

MOD. E



Juego
Mod. E
Set



Aceros
<850 N/mm²
Steel / Aciers

Fundición
Cast Iron
Fonte

Cobre
Copper
Cuivre

Latón
Brass
Laiton

Aluminio
Aluminium

Plásticos
Plastics
Plastiques



+



5 Pcs

Cont.	Nº Art.	€
Mango / Shank / Queue Porta Universal Holder E100 / E200 / E300	12805	



Ref. **8325**

CORTA TUBOS 25 mm

25 mm Pipe Cutters
Coupe tubes 25 mm



3-25 mm	1/8 - 1"			Mini Compact
---------	----------	--	--	--------------



INOX Stainless Steel Acier INOX	Cobre Copper Cuivre	Aluminio Aluminium	Mod.	Min. mm	Max. mm	Pulgadas Inches Pouces	Nº Art.	€
			25	3	25	1/8 - 1"	34244	

Ref. **8330**

CORTA TUBOS 30 mm

30 mm Pipe Cutters
Coupe tubes 30 mm



3-30 mm	1/8 - 1 1/8"			
---------	--------------	--	--	--



INOX Stainless Steel Acier INOX	Cobre Copper Cuivre	Aluminio Aluminium	Mod.	Min. mm	Max. mm	Pulgadas Inches Pouces	Nº Art.	€
			30	3	30	1/8 - 1 1/8"	34245	

Ref. **8335**

CORTA TUBOS 35 mm

35 mm Pipe Cutters
Coupe tubes 35 mm



3-35 mm	1/8 - 1 3/8"			
---------	--------------	--	--	--

Cambio Rápido Cuchilla
Quick Cutting Wheel Change
Changement rapide molette

Rebarbador incluido
Deburring Tool included
Ébavureur compris



INOX Stainless Steel Acier INOX	Cobre Copper Cuivre	Aluminio Aluminium	Mod.	Min. mm	Max. mm	Pulgadas Inches Pouces	Nº Art.	€
			35	3	35	1/8 - 1 3/8"	34246	

Ref. **8341**

CUCHILLAS REPUESTO

Spare Wheels
Lames de rechange

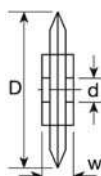

Mod.	D mm	d mm	w mm	Nº Art.	€
1	20	5	5	34247	



Ref. **8326**

CORTA TUBOS TIJERA PLÁSTICO Y MULTICAPA

Plastic & Multilayer Pipe Scissors

Coupe tubes ciseaux pour plastique et multicouche



26 mm
(1")

INOX+Teflon®
Stainless+Teflon®
INOX+Téflon®

Cuerpo Mg
Mg Body
Corps Mg

PE, PP, PB, PEX, MLP/MSR,
VPE, CPVC, PVC, PVDF, PPR

Mod.	Max. mm	Pulgadas Inches Pouces	Nº Art.	€
26	26	1"	36633	



- 1- Cuchilla INOX + Teflon®: Menor adherencia entre tubo y cuchilla
- 2- Zona de apoyo mejorada: Tubo mejor asentado, corte más preciso
- 3- Cambio cuchilla instantaneo: Sin necesidad de herramientas

- 1- Stainless + Teflon® blade: Lower adhesion between pipe & blade
- 2- Improved base area: Better leaned pipe, accurate cutting
- 3- Instant blade change: No tools needed

- 1- Lame INOX + Téflon®: Moindre adhérence entre tuyau et lame
- 2- Zone d'appui améliorée: Tuyau mieux fixé, coupe plus précis
- 3- Changement de lame immédiat: Sans besoin d'outils

Ref. **8321**

CUCHILLAS REPUESTO - Spare Blades - Lames de rechange

INOX+Teflon®
Stainless+Teflon®
INOX+Téflon®



Hoja
Blade
Lame
mm



Nº
Art.

€

26 1 37423



Ref. **8342**

CORTA TUBOS TIJERA PLÁSTICO Y MULTICAPA

Plastic & Multilayer Pipe Scissors

Coupe tubes ciseaux pour plastique et multicouche



42 mm
(1 5/8")

INOX+Teflon®
Stainless+Teflon®
INOX+Téflon®

Cuerpo Mg
Mg Body
Corps Mg

PE, PP, PB, PEX, MLP/MSR,
VPE, CPVC, PVC, PVDF, PPR

Mod.	Max. mm	Pulgadas Inches Pouces	Nº Art.	€
42	42	1"5/8	36635	



- 1- Cuchilla INOX + Teflon®: Menor adherencia entre tubo y cuchilla
- 2- Zona de apoyo mejorada: Tubo mejor asentado, corte más preciso
- 3- Cambio cuchilla instantaneo: Sin necesidad de herramientas
- 4- Cuchilla recogida en el cuerpo

- 1- Stainless + Teflon® blade: Lower adhesion between pipe & blade
- 2- Improved base area: Better leaned pipe, accurate cutting
- 3- Instant blade change: No tools needed
- 4- Blade positioned within the body

- 1- Lame INOX + Téflon®: Moindre adhérence entre tuyau et lame
- 2- Zone d'appui améliorée: Tuyau mieux fixé, coupe plus précis
- 3- Changement de lame immédiat: Sans besoin d'outils
- 4- Lame dans le corps de l'outil

Ref. **8321**

CUCHILLAS REPUESTO - Spare Blades - Lames de rechange

INOX+Teflon®
Stainless+Teflon®
INOX+Téflon®



Hoja
Blade
Lame
mm



Nº
Art.

€

42 1 37424



Ref. **8345****RECOGEVIRUTAS MAGNÉTICO**Magnetic Retrieving Baton
Aimant à copeaux

D mm	L mm	Nº Art.	€
25,40	400	69499	



Imán especialmente diseñado para recoger viruta ferrosa en lugares difícilmente accesibles. Ideal para cubos de almacenaje, limpieza de agua o desengrasado de tanques, muros y esquinas... Práctico extensor que deja caer el material recogido a la vez que protege la mano de la viruta.

Specially designed Magnet to retrieve ferrous metal materials from hard to reach locations. Ideal for storage bins, water cleaning or tank degreasing, walls and corners... Practical extension for an easy releasing the collected material. It protects the hand from the chips.

Aimant spécialement dessiné pour ramasser les copeaux de fer dans des zones de difficile accès. Conseillés pour nettoyage d'eau, murs, corners. Pratique extenseur qui permet que le matériel tombe une fois ramassé et protège les mains des copeaux.



CONSTRUCCIÓN

Construction

Construction



HERRAMIENTAS SDS PLUS

SDS plus Tools
Outils SDS plus

238



HERRAMIENTAS SDS MAX

SDS max Tools
Outils SDS max

248



ADAPTADOR iCONNECT

iConnect Adaptor
Adaptateur iConnect

252



CINCELES

Chisels
Burins

254



BROCAS MANGO CILÍNDRICO

Straight Shank Drill Bits
Forets queue cylindrique

259



CORONAS

Hole Saws
Tréfans

277

DISCOS DIAMANTE

Diamond Cutting Blades
Disques diamant

287



HERRAMIENTAS SDS PLUS

SDS plus Tools

Outils SDS plus

Ref. **1891**

BROCA-MARTILLO SDS PLUS 4Z+

4Z+ Cutter SDS plus Rotary Hammer Drill Bit

Foret percussion SDS plus 4Z+

Zentro 4+



Zentro
4+
<10mm

Zentro
4
10-16 mm

SDS
plus



Video



Hormigón Reforzado
Reinforced Concrete
Béton armé

Hormigón
Concrete
Béton

Hormigón Bloque
Concrete Block
Parpaing

Piedra Natural
Natural Stone
Pierre naturelle



Punta centradora MD soldada al cuerpo
Solid carbide centering tip welded to the body
Pointe autocentrante carbure soudée au corps



Hombros reforzados
⇒ Mejor rotura del material.
Marca desgaste

Reinforced shoulders
⇒ Better material breaking.
Wear Marking

Épaules de la pointe reforçadas
⇒ Meilleure rupture du matériel.
Marque l'usure.



Diseño núcleo reforzado exclusivo
⇒ Mejor rendimiento y vida más larga

Exclusive reinforced core design
⇒ Better performance & longer life



Dessin noyau renforcé et exclusif
⇒ Meilleure performance et vie de l'outil plus longue



Ref. **1891**

BROCA-MARTILLO SDS PLUS 4Z+

4Z+ Cutter SDS plus Rotary Hammer Drill Bit
Foret percussion SDS plus 4Z+

D mm	L mm	I mm		Nº Art.	€	D mm	L mm	I mm		Nº Art.	€	D mm	L mm	I mm		Nº Art.	€
5,00	115	50	1	32043		10,00	115	50	1	32058		14,00	450	400	1	36692	
5,00	165	100	1	32044		10,00	165	100	1	32059		14,00	600	550	1	36693	
5,00	215	150	1	55961		10,00	215	150	1	32060		14,00	1000	950	1	36694	
5,00	265	200	1	66376		10,00	265	200	1	32061		15,00	160	110	1	60059	
5,00	315	250	1	69437		10,00	315	250	1	32062		15,00	260	210	1	60061	
5,50	115	50	1	32041		10,00	455	400	1	32063		15,00	450	400	1	60062	
5,50	165	100	1	32042		10,00	600	550	1	36688		16,00	160	110	1	36695	
6,00	115	50	1	32045		10,00	1000	950	1	36689		16,00	210	160	1	36696	
6,00	165	100	1	32046		11,00	160	110	1	69899		16,00	260	210	1	36863	
6,00	215	150	1	32047		11,00	210	160	1	69902		16,00	310	260	1	36699	
6,00	265	200	1	32048		11,00	260	210	1	69904		16,00	450	400	1	37455	
6,00	315	250	1	32049		11,00	310	260	1	81562		16,00	600	550	1	22113	
6,50	165	100	1	32050		12,00	160	110	1	32064		16,00	1000	950	1	36698	
6,50	215	150	1	32074		12,00	210	160	1	32065		18,00	250	200	1	16919	
6,50	265	200	1	32072		12,00	260	210	1	32066		18,00	450	400	1	16920	
6,50	315	250	1	32073		12,00	310	260	1	32067		20,00	250	200	1	16921	
7,00	115	50	1	32052		12,00	450	400	1	32068		20,00	450	400	1	16922	
7,00	165	100	1	32053		12,00	600	550	1	36690		22,00	250	200	1	39687	
7,00	215	150	1	68615		12,00	1000	950	1	36697		22,00	450	400	1	16925	
8,00	115	50	1	32054		13,00	160	110	1	69905		24,00	250	200	1	39688	
8,00	165	100	1	32055		13,00	210	160	1	69907		24,00	450	400	1	16927	
8,00	215	150	1	32056		13,00	260	210	1	69908		25,00	250	200	1	39689	
8,00	265	200	1	32057		13,00	310	260	1	81563		25,00	450	400	1	16928	
8,00	315	250	1	36686		14,00	160	110	1	32069		28,00	250	200	1	11523	
8,00	465	400	1	36687		14,00	210	160	1	32070		28,00	450	400	1	11524	
New! 8,00	605	540	1	85112		14,00	260	210	1	32071		30,00	250	200	1	39690	
9,00	165	100	1	56808		14,00	310	260	1	36691		30,00	450	400	1	11525	
												32,00	450	400	1	11526	



Línea 1 m - Ref. 1891



∅	5	6	7	8	10	5	6	7	8	10	12	14	6	8	10	12	14	8	16
	L115	L115	L115	L115	L115	L165	L165	L165	L165	L165	L160	L160	L215	L215	L215	L210	L210	L265	L260
Pcs	2	2	2	2	2	2	2	2	2	2	2	2	2	2	2	2	2	2	2

Ref. 4995 - Nº Art. 71015: €



Display 67 - Ref. 1891 -1-



∅	24 L250	6 L315	8 L315	10 L315	12 L310	14 L310	16 L310	8 L465
Pcs	1	2	2	1	1	1	1	1
∅	5 L215	6 L215	8 L215	10 L215	12 L210	14 L210	16 L210	6 L265
Pcs	3	3	3	2	2	2	2	2
∅	5 L115	6 L115	7 L115	8 L115	10 L115	5 L165	6 L165	6 L165
Pcs	4	4	4	4	3	4	3	3

Ref. 4995 - N° Art. 75389: €

Display 68 - Ref. 1891 -2-



∅	10 L455	12 L450	14 L450	16 L450	18 L450	20 L450	22 L450	24 L450
Pcs	1	1	1	1	1	1	1	1
∅	8 L265	10 L265	12 L260	14 L260	16 L260	18 L250	20 L250	22 L250
Pcs	2	2	1	1	1	1	1	1
∅	7 L165	8 L165	9 L165	10 L165	12 L160	14 L160	15 L160	16 L160
Pcs	2	2	2	2	1	1	1	1

Ref. 4995 - N° Art. 75391: €

Display 61 - Ref. 1891 -BásicoăBasic-Essentiel-



∅	14 L210	6 L265	8 L265	10 L265	12 L260	6 L315	10 L315	12 L310
Pcs	2	2	2	2	2	2	2	2
∅	8 L165	10 L165	12 L160	14 L160	6 L215	8 L215	10 L215	12 L210
Pcs	2	2	2	2	2	2	2	2
∅	5 L115	6 L115	7 L115	8 L115	10 L115	5 L165	6 L165	7 L165
Pcs	2	2	2	2	2	2	2	2

Ref. 4995 - N° Art. 29487: €



Display 31 - Ref. 1891

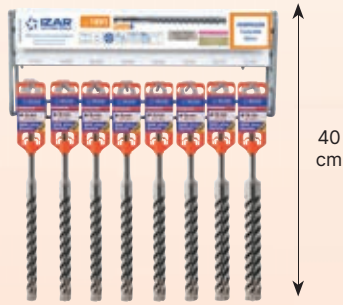

∅	16	18	20	22	24	25	28	30
	L260	L250	L250	L250	L250	L250	L250	L250
Pcs	1	1	1	1	1	1	1	1

Ref. 4995 - N° Art. 22615: €

Display 32 - Ref. 1891



∅	16	18	20	22	24	25	28	30
	L450	L450	L450	L450	L450	L450	L450	L450
Pcs	1	1	1	1	1	1	1	1

Ref. 4995 - N° Art. 22617: €



Ref. **1869**

BROCA-MARTILLO SDS PLUS 4Z+

4Z+ Cutter SDS plus Rotary Hammer Drill Bit
Foret percussion SDS plus 4Z+



D mm	L mm	I mm		N° Art.	€ 1 ud.
5	115	50	10	56503	
5	165	100	10	56506	
6	115	50	10	56507	
6	165	100	10	56509	
6	215	150	10	56510	
8	115	50	10	56967	
8	165	100	10	56971	

D mm	L mm	I mm		N° Art.	€ 1 ud.
8	215	150	10	56972	
10	115	50	10	56973	
10	165	100	10	56974	
10	215	150	10	56976	
12	160	110	10	56978	
12	210	160	10	56979	



Set **1489**

7 Pcs

Cont. ∅	N° Art.	€
5-6-8 × 115 + 6-8-10-12 × 165 mm	39851	

Ref. **1890**

BROCA-MARTILLO SDS PLUS

SDS plus Rotary Hammer Drill Bit
Foret percussion SDS plus

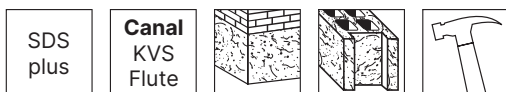

Hormigón
Concrete
Béton

Hormigón Bloque
Concrete Block
Parpaing



Puntos de desbaste efecto "demolición".
Producen micro-fisuras en el material.

"Demolition" effect power breakers.
Produce micro cracks in the material.

Points d'ébauche effet "démolition".
Produit des micro-fissures dans le matériel.



Punta centrado inmediato.
Previene que resbale en superficies lisas.

Immediate centering tip.
Prevent skidding on smooth surfaces.

Pointe Autocentrage immédiat.
Il prévient le glissement sur Surfaces lisses.





Chañflanes de acero corrugado más extenso (+35%).
Previenen daños laterales en la punta.

Enlarged rebar chamfers (+35%).
Prevent side tip damage.

Chanfreins aciers contractés plus étendus (+35%).
Il prévient des dommages aux côtés de la pointe.



D mm	L mm	I mm		Nº Art.	€	D mm	L mm	I mm		Nº Art.	€	D mm	L mm	I mm		Nº Art.	€
4,00	110	50	1	30245		9,00	160	100	1	11518		15,00	160	100	1	30286	
4,00	160	100	1	43405		9,00	210	150	1	11519		15,00	210	150	1	69917	
5,00	110	50	1	30246		10,00	110	50	1	30261		15,00	260	200	1	42773	
5,00	160	100	1	30247		10,00	160	100	1	30262		15,00	450	400	1	70642	
5,00	210	150	1	42770		10,00	210	150	1	18541		16,00	160	100	1	30291	
5,00	260	200	1	70631		10,00	260	200	1	30263		16,00	210	150	1	30292	
5,00	310	250	1	69445		10,00	310	250	1	30264		16,00	260	200	1	42774	
5,00	360	300	1	70633		10,00	450	400	1	30266		16,00	310	250	1	30294	
5,00	460	400	1	70634		10,00	600	550	1	30267		16,00	450	400	1	30295	
5,50	110	50	1	23976		10,00	800	740	1	70640		16,00	600	550	1	30296	
5,50	160	100	1	23977		10,00	1000	950	1	69911		16,00	800	750	1	30298	
5,50	210	150	1	70636		11,00	160	100	1	11520		16,00	1000	950	1	30290	
5,50	260	200	1	69446		11,00	210	150	1	25600		18,00	200	150	1	30300	
5,50	310	250	1	70637		11,00	260	200	1	11521		18,00	300	250	1	30413	
6,00	110	50	1	30248		12,00	160	100	1	30270		18,00	450	400	1	30303	
6,00	160	100	1	18538		12,00	210	150	1	30271		18,00	1000	950	1	30299	
6,00	210	150	1	30249		12,00	260	200	1	30273		20,00	200	150	1	30306	
6,00	260	200	1	30251		12,00	310	250	1	42771		20,00	300	250	1	30309	
6,00	310	250	1	70639		12,00	450	400	1	30414		20,00	450	400	1	30311	
6,00	460	400	1	69448		12,00	600	550	1	30275		20,00	600	550	1	30312	
6,50	110	50	1	23978		12,00	800	750	1	69916		20,00	1000	950	1	30305	
6,50	160	100	1	23979		12,00	1000	950	1	30269		22,00	250	200	1	30314	
6,50	260	200	1	59957		13,00	160	100	1	30276		22,00	450	400	1	30317	
7,00	110	50	1	30252		13,00	210	150	1	74789		22,00	600	550	1	23980	
7,00	160	100	1	30253		13,00	310	250	1	30278		22,00	1000	950	1	23986	
7,00	210	150	1	68614		13,00	450	400	1	55407		24,00	250	200	1	30319	
7,00	250	200	1	19592		14,00	160	100	1	30280		24,00	450	400	1	30322	
8,00	110	50	1	30254		14,00	210	150	1	30281		25,00	250	200	1	30324	
8,00	160	100	1	18540		14,00	260	200	1	42772		25,00	450	400	1	30327	
8,00	210	150	1	30255		14,00	310	250	1	30283		25,00	1000	950	1	23987	
8,00	260	200	1	30256		14,00	450	400	1	30284		26,00	250	200	1	11522	
8,00	460	400	1	30257		14,00	600	550	1	30285		26,00	450	400	1	30330	
8,00	1000	950	1	70030		14,00	1000	950	1	30279							



Línea 1 m - Ref. 1890



∅	5	6	7	8	10	5	6	7	8	10	12	14	6	8	10	12	14	8	16
	L110	L110	L110	L110	L110	L160	L160	L160	L160	L160	L160	L160	L210	L210	L210	L210	L210	L260	L260
Pcs	5	5	3	5	3	5	5	3	3	3	3	3	3	3	3	3	3	2	2
Ref. 4995 - N° Art. 71017:										€									

Display 01 - Ref. 1890 -1-



∅	18	20	22	24	25	8	10	12											
	L300	L300	L250	L250	L250	L460	L450	L450											
Pcs	1	1	1	1	1	2	2	2											
∅	6	8	10	12	14	16	18	20											
	L210	L210	L210	L210	L210	L210	L200	L200											
Pcs	3	3	3	3	3	1	1	1											
∅	4	5	6	7	8	10	5	6	7	8									
	L110	L110	L110	L110	L110	L110	L160	L160	L160	L160									
Pcs	5	5	5	3	5	3	5	5	3	3									
Ref. 4995 - N° Art. 22182:										€									



Display 02 - Ref. 1890 -2-



∅	14	16	18	20	22	24	25	26											
	L450	L450	L450	L450	L450	L450	L450	L450											
Pcs	3	1	1	1	1	1	1	1											
∅	6	8	10	12	10	13	14	16											
	L260	L260	L260	L260	L310	L310	L310	L310											
Pcs	3	3	3	3	3	2	2	2											
∅	9	10	11	12	13	14	15	16											
	L160	L160	L160	L160	L160	L160	L160	L160											
Pcs	2	2	2	3	3	3	2	2											
Ref. 4995 - N° Art. 22183:										€									

Display 45 - Ref. 1890



∅	12 L260	14 L310	16 L310	8 L460	10 L450	12 L450	14 L450	16 L450		
Pcs	3	2	2	1	1	2	1	1		
∅	14 L160	16 L160	6 L210	8 L210	10 L210	12 L210	14 L210	10 L260		
Pcs	3	2	5	3	3	3	3	3		
∅	4 L110	5 L110	6 L110	8 L110	10 L110	5 L160	6 L160	8 L160	10 L160	12 L160
Pcs	5	5	5	5	5	5	5	5	4	3

Ref. 4995 - N° Art. 55614: €



Display 25 - Ref. 1890



∅	4 L110	5 L110	6 L110	7 L110	8 L110	10 L110	5 L160	6 L160	7 L160	8 L160
Pcs	5	5	5	3	5	3	5	5	3	3

Ref. 4995 - N° Art. 22278: €

Display 26 - Ref. 1890



∅	9 L160	10 L160	11 L160	12 L160	13 L160	14 L160	15 L160	16 L160
Pcs	2	2	2	3	3	3	2	2

Ref. 4995 - N° Art. 22604: €



Display 27 - Ref. 1890



∅	6	8	10	12	14	16	18	20
	L210	L210	L210	L210	L210	L210	L200	L200
Pcs	3	3	3	3	3	1	1	1

Ref. 4995 - N° Art. 22605: €

Display 28 - Ref. 1890



∅	6	8	10	12	10	13	14	16
	L260	L260	L260	L260	L310	L310	L310	L310
Pcs	3	3	3	3	3	2	2	2

Ref. 4995 - N° Art. 22609: €

Display 29 - Ref. 1890



∅	18	20	22	24	25	8	10	12
	L300	L300	L250	L250	L250	L460	L450	L450
Pcs	1	1	1	1	1	2	2	2

Ref. 4995 - N° Art. 22612: €

Display 30 - Ref. 1890



∅	14	16	18	20	22	24	25	26
	L450	L450	L450	L450	L450	L450	L450	L450
Pcs	3	1	1	1	1	1	1	1

Ref. 4995 - N° Art. 22614: €





Ref. **1899**

BROCA-MARTILLO SDS PLUS

SDS plus Rotary Hammer Drill Bit
Foret percussion SDS plus



D mm	L mm	I mm		Nº Art.	€ 1 ud.
5	110	50	10	18706	
5	160	100	10	18707	
6	110	50	10	18710	
6	160	100	10	18712	
6	210	150	10	18714	
7	160	100	10	74777	
8	110	50	10	18715	
8	160	100	10	18716	
8	210	150	10	18717	

D mm	L mm	I mm		Nº Art.	€ 1 ud.
10	110	50	10	18719	
10	160	100	10	18721	
10	210	150	10	18722	
12	160	100	10	18723	
12	210	150	10	18724	
13	160	100	10	74778	
13	210	150	10	74780	
14	160	100	10	74782	
14	210	150	10	74783	



Set **1494**

4 Pcs

Cont. Ø	Nº Art.	€
5×110 6×110 8×160 10×160 mm	11528	



Set **1497**

7 Pcs

Cont. Ø	Nº Art.	€
5-6-8 × 110 + 6-8-10-12 × 160 mm	11529	

Línea 33 cm - 14S2 - Refs. 1899 - 1886 - 1880

SETS BROCAS HORMIGÓN, PARED PRO, PARED

Concrete, Masonry Sets
Jeux béton, maçonnerie



	Hormigón Concrete Béton	Pared Pro Concrete Béton	Pared Masonry Maçonnerie
Ref	Set 1494 - Ref. 1899	Set 1487 - Ref. 1886	Set 1488 - Ref. 1880
Ø	5/6×110 + 8/10×160 mm	3-4-5-6-7-8-9-10 mm	3-4-5-6-7-8-9-10 mm
Pcs.	3	5	5

Ref. 4995 - Nº Art. 72194: €



Ref. **1695**

CORONA LIGERA PARED PROFESIONAL

Professional Concrete Light Hollow Core Bit
Trépan béton professionnel



Diente MD
Carbide Tipped
Dent Carbure



SDS plus

Rosca Interna M-16
M-16 Internal Thread
Filetage Intérieur M-16



Hormigón
Concrete
Béton

Hormigón Bloque
Concrete Block
Parpaing

Ladrillo
Brick
Brique



- Más robusta
- Nueva geometría de canales mejorada

- Now Stronger
- New improved channel geometry

- Plus robuste
- Nouvelle géométrie améliorée des goujures

D mm	L mm	Nº Art.	€	D mm	L mm	Nº Art.	€	D mm	L mm	Nº Art.	€
30	50	13898		50	50	13902		82	50	19032	
35	50	13899		65	50	13904		90	50	25207	
40	50	13900		68	50	19012		100	50	25208	
45	50	13901		80	50	19014					

* Accesorios no incluidos / Accessories not included / Accessoires non inclus

Ref. **1696**

ACCESORIOS – Accessories – Accessoires



Broca Centrar
Center Drill / Foret à Centrer



00001

Broca	D mm	L mm	Nº Art.	€
Drill Bit Mod. Foret Mod.	1	8 120	18857	

Husillo SDS plus
SDS plus Spindle / Arbre SDS plus



00003-5

SDS plus Mod.	L mm	Nº Art.	€
3	105	18858	
4	220	19021	
5	370	19023	

Husillo Hex
Hex Spindle / Arbre Hex



00006-8

HEX Mod.	L mm	Nº Art.	€
6	100	19018	
7	220	19026	
8	370	19030	

Display 05 - Ref. 1695



Ø	SDS plus L110	SDS plus L110	SDS plus L220	SDS plus L350
Pcs	1	1	2	1
Ø	40	50	50	Broca Drill Bit Foret
Pcs	1	1	1	2 1
Ø	65	68	80	82
Pcs	1	1	1	1

Ref. 4995 - Nº Art. 22418: €



HERRAMIENTAS SDS MAX

SDS max Tools

Outils SDS max

Ref. **1892**

BROCA-MARTILLO SDS MAX 4 PUNTAS

4-Cutter SDS max Rotary Hammer Drill Bit

Foret percussion SDS max 4 pointes



SDS max								Marca desgaste Wear Marking Témoin d'usure
---------	--	--	--	--	--	--	--	---

Hormigón Reforzado Reinforced Concrete Béton armé	Hormigón Concrete Béton	Hormigón Bloque Concrete Block Parpaing
--	-----------------------------------	--



2 puntas / 2-Cutter / 2-Taillants:

D mm	L mm	I mm	Nº Art.	€
12	340	200	30332	
12	540	400	30333	
12	690	550	30334	
14	340	200	30335	
14	540	400	30336	
15	340	200	30337	
15	540	400	30338	

4 puntas / 4-Cutter / 4-Taillants:

D mm	L mm	I mm	Nº Art.	€
16	340	200	30339	
16	540	400	30340	
16	940	800	60065	
16	1320	1180	60066	
18	340	200	30341	
18	540	400	30342	
18	940	800	60068	
18	1320	1180	60070	
20	320	200	30343	
20	520	400	30344	
20	920	800	30345	
20	1320	1200	60072	
22	320	200	30346	
22	520	400	30347	
22	920	800	30348	
22	1320	1200	60075	
24	320	200	30349	
24	520	400	30350	
25	320	200	30351	
25	520	400	30352	
25	920	800	30353	
25	1320	1200	60077	
26	520	400	30354	
28	370	250	30355	
28	570	450	30356	
28	670	550	30357	
28	920	800	60079	
30	370	250	30358	
30	570	450	30359	
32	370	250	30360	
32	570	450	30361	
32	920	800	30362	
32	1320	1200	60085	
35	370	250	30363	
35	570	450	30364	
35	670	550	30365	
35	920	800	38103	
37	370	250	60088	
37	570	450	60089	
37	920	800	60090	
38	370	250	30366	
38	570	450	30367	
38	720	600	79736	
38	920	800	79737	
40	370	250	30368	
40	570	450	30369	
40	920	800	30370	
40	1320	1200	60093	
45	570	450	30371	
45	920	800	23981	
50	570	450	52952	
52	570	450	52954	

New!

Línea 1 m - Ref. 1892



∅	16	16	18	18	20	20	22	22	25	25	28	28	30	30	32	35
	L340	L540	L340	L540	L320	L520	L320	L520	L320	L520	L370	L570	L370	L570	L570	L570
Pcs	1	1	1	1	1	1	1	1	1	1	1	1	1	1	1	1

Ref. 4995 - Nº Art. 72141: €



Display 03 - Ref. 1892



∅	16	18	20	22	25	28	30	32	35
	L540	L540	L520	L520	L520	L570	L570	L570	L570
Pcs	1	1	1	1	1	1	1	1	1

∅	12	14	16	18	20	22	25	28	30
	L340	L340	L340	L340	L320	L320	L320	L370	L370
Pcs	1	1	1	1	1	1	1	1	1

Ref. 4995 - N° Art. 22315: €



Display 33 - Ref. 1892



49
cm

∅	12	14	16	18	20	22	25	28	30
	L340	L340	L340	L340	L320	L320	L320	L370	L370
Pcs	1	1	1	1	1	1	1	1	1

Ref. 4995 - N° Art. 22618: €

Display 34 - Ref. 1892



68
cm

∅	16	18	20	22	25	28	30	32	35
	L540	L540	L520	L520	L520	L570	L570	L570	L570
Pcs	1	1	1	1	1	1	1	1	1

Ref. 4995 - N° Art. 22619: €

Ref. **1894**

CORONA SDS MAX

SDS max Core Cutter
Foret trépan SDS max

¡NUEVO MODELO MEJORADO!
New improved model!
Nouveau modèle amélioré !



SDS max

Nuevo Diseño Especial Hormigón Reforzado
New Special Design for Reinforced Concrete
Nouveau dessin pour béton armé

Hormigón
Concrete
Béton

Hormigón Bloque
Concrete Block
Parpaing



- Punta de centrar 3 cortes para una mayor precisión y vida útil
- 3-cutter centering tip for increased precision and long lifetime
- Pointe de centrage à 3 coupes pour une précision et une durabilité accrues



- 3 alas, con un diseño y solidez del núcleo, para perforaciones rápidas (incluso en hormigón armado) y máxima resistencia a la fractura
- 3-piece outer rim-design and solid core strength, for fast drilling (even in reinforced concrete) and maximum fracture resistance
- 3 arêtes, avec un design et une solidité du noyau, pour des perforations rapides (même dans le béton armé) et une résistance maximale à la rupture



- Dientes de metal duro con una óptima geometría. Innovadoras fases de centrado para prevenir la rotura de los dientes. Un nuevo diseño para un progreso de perforación mayor
- Carbide teeth with optimal geometry. Innovative centering phases for preventing tooth failures. A new design for enhanced drilling progress
- Dents en carbure avec une géométrie optimale. Phases de centrage innovantes pour prévenir la casse des dents. Un nouveau design pour une progression de perçage accrue

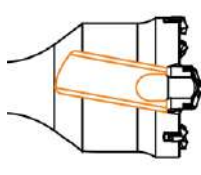

- 3 canales de evacuación de polvo con mayor pendiente para evacuación más rápida y de mayor volumen
- 3 dust channels with a steeper slope for faster and better drilling dust removal
- 3 canaux d'évacuation de la poussière avec une pente plus prononcée pour une évacuation plus rapide et en plus grande quantité

- Diámetro exterior aerodinámico para mayor velocidad y reducción de la fricción
- Aerodynamic outer diameter for higher speed and reduced friction
- Diamètre extérieur aérodynamique pour une vitesse accrue et une réduction de la friction

D mm	L mm	I mm	Nº Art.	€
45	550	450	16864	
45	990	890	16865	
55	550	450	16868	
55	990	890	16869	
65	550	450	16870	
65	990	890	16871	
80	550	450	16873	
80	990	890	16874	



Ref. **1697**

CORONA PERFORADORA TALADRO PERCUTOR

Tapered Hollow Hammer Core Bit
Trépan pour perçuses percussion lourds



Diente MD
Carbide Tipped
Dent Carbure

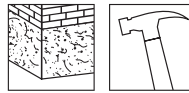

SDS
max

Conicidad 1:8
1:8 Tapered
Conicité 1:8

Hormigón
Concrete
Béton



D mm	L mm	Nº Art.	€
40	100	19035	
50	100	19041	
65	100	19045	
80	100	19047	
90	100	19048	
100	100	19050	
125	100	19051	



* **Accesorios no incluidos**
Accessories not included
Accessoires non inclus

Ref. **1698**

ACCESORIOS – Accesories – Accessoires



Broca Centrar
Center Drill
Foret à centrer



00001

Broca Drill Bit Foret Mod.	D mm	L mm	Nº Art.	€
1	11	120	19054	

Cuña Expulsora Ref. 1104
Drill Drift
Chasse



00002

CM min.	CM max.	L mm	Nº Art.	€
1	2	116	16436	

Husillo SDS max
SDS max Spindle
Arbre SDS max



00003-4

SDS max Mod.	L mm	Nº Art.	€
3	180	19057	
4	450	19058	

Display 06 - Ref. 1697



∅	Llave Key / Clé	Broca Drill Bit / Foret	Broca Drill Bit / Foret	SDS max L180	SDS max L180	SDS max L450
Pcs	3	2	1	2	1	1
∅	40	50	65	80		
Pcs	1	1	1	1		

Ref. 4995 - Nº Art. 22463: €



ADAPTADOR iCONNECT

iConnect Adaptor

Adaptateur iConnect

Descripción

iConnect permite taladrar agujeros extremadamente profundos con una broca-martillo corta, de una manera mucho más económica gracias a su sistema de adaptadores y alargadores. Estos alargadores permiten incluso la combinación de un taladro SDS plus con una broca SDS max.

Ventajas

- 2 clicks y ya tiene la broca de la longitud que necesita
- ñ Las dos entradas SDS max del adaptador consiguen una conexión rápida y segura entre la broca y los diferentes alargadores
- Con el adaptador iConnect no hay pérdida de energía, algo habitual en otros sistemas tradicionales de adaptadores
- ñ No hay posibilidad de rotura por causa de una excesiva presión en el área de unión
- ñ Reducción al mínimo de las herramientas necesarias para el taladrado profesional

Uso

Hormigón, pared y piedra natural

Description

iConnect allows drilling extremely deep holes with a short hammer drill bit, in very inexpensive way thanks to this system of adaptors and extensions. These extensions allow even the combination of a SDS plus drilling machine with a SDS max rotary hammer drill bit.

Advantages

- 2 clicks and the tools is the required length
- The adaptor's two SDS max chucks provide a quick and safe connection between the drilling tool and the extension shanks
- With the iConnect adaptor there is no energy loss, normally encountered in traditional adapter systems
- ñ Breakages because of excessive strain in the coupling area are not possible
- Professional drilling tool requirements reduced to a minimum

Use

Concrete, masonry and natural stone

Description

IConnect permet percer des trous très profonds avec un foret percussion court, d'une façon beaucoup plus économique grâce à son système d'adaptateurs et rallonges.

Ces rallonges permettent aussi une combiner un perçage SDS PLUS avec un foret SDS Max.

Avantages

- En 2 clicks vous obtenez la longueur du foret que vous avez besoin.
- ñ Les 2 entrées SDS MAX de l'adaptateur vous permettent une connexion rapide entre le foret et les différents rallonges.
- ñ Avec l'adaptateur IConnect pas de perte d'énergie, comme dans d'autres systèmes.
- Pas de rupture à cause d'une haute pression dans la zone de la connexion d'union.
- Réduire au minimum les outils pour le perçage professionnel.

Emploi

Béton Armé, Béton et Pierre.

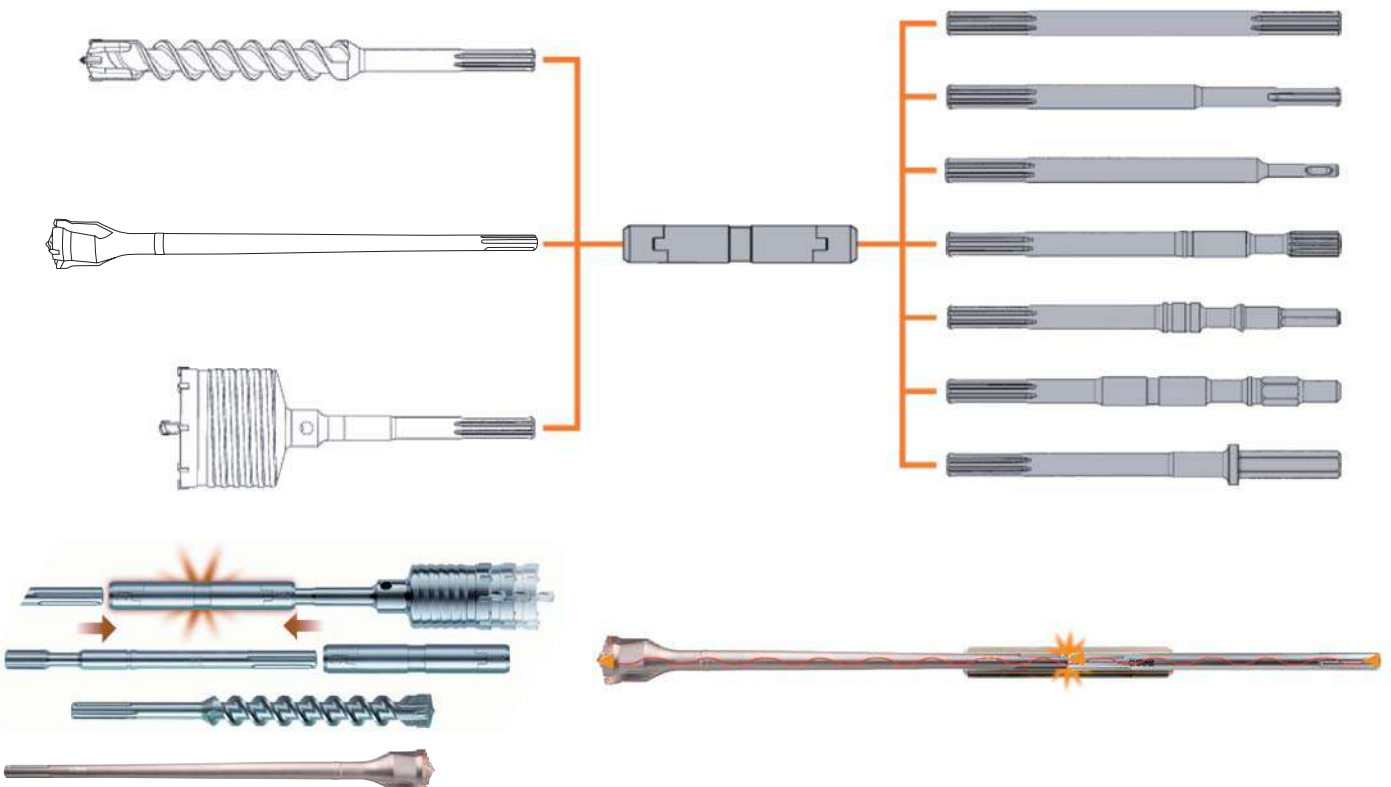

Ref. **1875**

ADAPTADOR SDS MAX

SDS max Adaptor
Adaptateur SDS max



SDS
max



Hormigón
Concrete
Béton

Hormigón Bloque
Concrete Block
Parpaing



Adaptador Mod.	L mm	d mm	Nº Art.	€
1	190	30	56810	



Extensión MAX-MAX Mod.	L mm	Nº Art.	€
0320-MAX	320	56811	
0750-MAX	750	56812	
1100-MAX	1100	56813	



Extensión MAX-PLUS	L mm	Nº Art.	€
0320-PLUS	320	56814	
0750-PLUS	750	56815	



Grasa Grease / Graisse Mod.	Nº Art.	€
2	57504	



*** INSTRUCCIONES USO**
Directions for use
Instructions d'emploi



CINCELES
Chisels
Burins



Ref. 1872



Ref. 1870

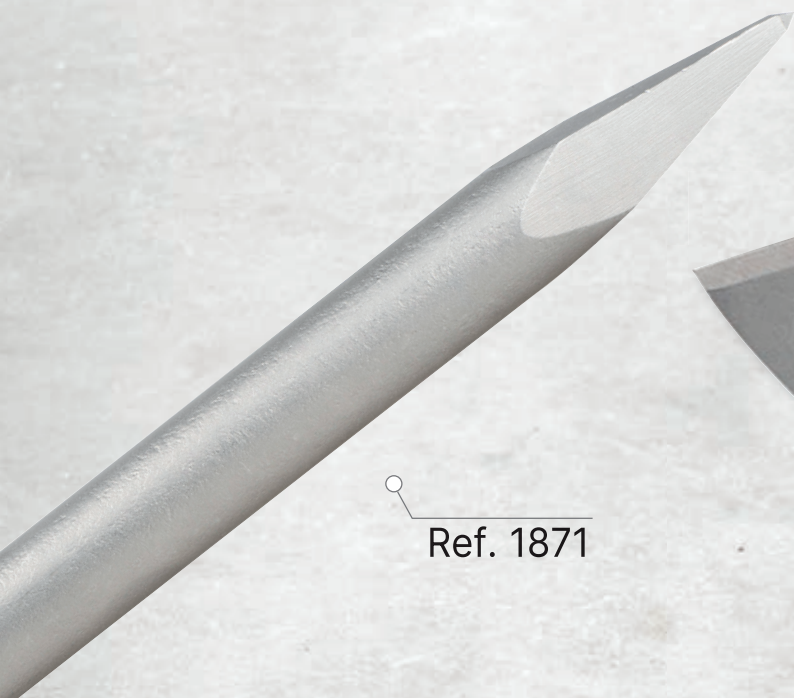

Ref. 1871

Ref. **1870**

CINCEL SDS PLUS

SDS plus Chisel
Burin SDS plus

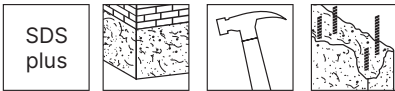

Hormigón Reforzado
Reinforced Concrete
Béton armé

Hormigón
Concrete
Béton



	Mod.	Tipo Type / Type	L mm	I mm	Nº Art.	€
 Puntero / Pointed / Ciseau	00001-250	Puntero / Pointed / Ciseau	250		30372	
 Plano / Flat / Plate	00002-250	Plano / Flat / Plate	250	20	30373	
 Ancho / Wide / Large	00003-200038	Ancho / Wide / Large	200	38	30374	
 Hueco / Hollow / Gouge	00004-240	Hueco / Hollow / Gouge	240	22	30375	
 Alas / Wing-Canal / Ailes	00005-250	Alas / Wing-Canal / Ailes	250	22	54983	
 Azulejo / Tile / Carreau	00009-200038	Azulejo Tile / Carreau	200	38	54985	
	00009-250060		250	60	54986	
 Dentado / Slotting / Denté	00010-200032TCT	Dentado / Slotting / Denté	200	32	54988	
 Ancho / Wide / Large	00011-250040	Ancho / Wide / Large	250	40	82692	

Refilable
Resharpenable
Réaffûtable



Ref. **1872**

CINCEL SDS MAX

SDS max Chisel
Burin SDS max



SDS
max

Hormigón Reforzado
Reinforced Concrete
Béton armé

Hormigón
Concrete
Béton



Puntero / Pointed / Ciseau



Plano / Flat / Plate



Ancho / Wide / Large



Hueco / Hollow / Gouge



Alas / Wing-Canal / Ailes



Acanalador / Canal / Gouge-Brique



Azulejo / Tile / Carreau



Dentado / Slotting / Denté



Pala / Clay-Spade / Pelle



Asfalto / Asphalt / Asphalte



Abujardar / Bushing / Bouchardage

Mod.	Tipo Type / Type	L mm	I mm	Nº Art.	€
00001-280	Puntero Pointed / Ciseau	280		54989	
00001-400		400		30376	
00001-600		600		23036	
00002-280	Plano Flat / Plate	280	24	54990	
00002-400		400	24	30377	
00002-600		600	24	23037	
00003-360050	Ancho Wide / Large	360	50	23038	
00003-300080		300	80	30378	
00003-350115		350	115	54991	
00004-300	Hueco Hollow / Gouge	300	26	30379	
00005-380035	Alas Wing-Canal / Ailes	380	35	18186	
00008-300032	Acanalador Canal / Gouge-Brique	300	32	54993	
00009-300050	Azulejo Tile / Carreau	300	50	54994	
00009-300080		300	80	54996	
00010-280038TCT	Dentado Slotting / Denté	280	38	54999	
00011-400110	Pala Clay-Spade / Pelle	400	110	55000	
00012-400090	Asfalto Asphalt / Asphalte	400	90	55003	
00013-240045	Abujardar Bushing Bouchardage	240	45x 45	55004	



Línea 33 cm - Ref. 1870



	Puntero Pointed Ciseau	Plano Flat Plate	Ancho Wide Large	Hueco Hollow Gouge
∅				
Pcs	2	2	2	2

Ref. 4995 - N° Art. 71023: €

Display 04 - Refs. 1872 - 1870



SDS MAX Ref. 1872

	Puntero Pointed Ciseau L400	Plano Flat Plate L400	Ancho Wide Large 50	Ancho Wide Large 80	Hueco Hollow Gouge	Alas Wing-Canal Ailes L380	Puntero Pointed Ciseau L600	Plano Flat Plate L600
∅								
Pcs	2	2	2	2	2	2	1	1

Display 35

Ref. 4995
N° Art. 22621
€



SDS PLUS Ref. 1870

	Puntero Pointed Ciseau	Puntero Pointed Ciseau	Plano Flat Plate	Plano Flat Plate	Ancho Wide Large	Ancho Wide Large	Hueco Hollow Gouge	Hueco Hollow Gouge
∅								
Pcs	1	1	1	1	1	1	1	1

Display 36

Ref. 4995
N° Art. 22623
€

Ref. 4995 - N° Art. 22289: €

Ref. **1871**

CINCEL HEXAGONAL 30 mm *

HEX Shank Chisel *

Burin hexagonal *



Hormigón Reforzado
Reinforced Concrete
Béton armé

Hormigón
Concrete
Béton

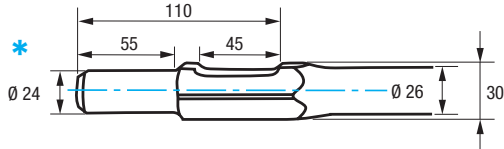

* **Mango rebajado**
Reduced Shank
Queue reduite | $\varnothing 24 \times 55 \text{ mm}$



Puntero / Pointed / Ciseau

00001-400

Puntero / Pointed / Ciseau

400

70710

€



Plano / Flat / Plate

00002-400

Plano / Flat / Plate

400

75 | 70712



BROCAS MANGO CILÍNDRICO

Straight Shank Drill Bits

Forets queue cylindrique

Ref. **1882**

BROCA PORCELÁNICO
PORCELAIN Drill Bit
Foret PORCELAINE

¡MODELO EXCLUSIVO!

IZAR
CUTTING TOOLS



Sin percusión
No percussion
Sans percussioin



H₂O
Refrigerar punta
Point Cooling
Refroidir la pointe



Video



Porcelánico
Porcelain
Porcelaine

Teja, piedra, pizarra, cemento, terrazo, mármol, terracota, calizas
Tile, quarry, slate, cement, terrazzo, marble, terracotta, limestones
Tuile, pierre, ardoise, ciment, terrazzo, marbre, terre cuite, calcaires

D mm	L mm	I mm	d mm		Nº Art.	€
3,00	85	50	3,0	1	13903	
3,50	85	50	3,0	1	13906	
4,00	85	50	3,5	1	13909	
4,50	85	50	4,0	1	13910	
5,00	85	50	4,5	1	14030	
6,00	100	65	5,5	1	14036	
7,00	125	75	6,5	1	14061	
8,00	125	75	7,5	1	14062	
9,00	150	90	8,5	1	14063	
10,00	150	90	9,5	1	14066	
11,00	150	90	10,0	1	14068	
New! 12,00	150	90	10,0	1	56521	



Set **1482**

4 Pcs

Cont. Ø	Nº Art.	€
4-5-6-8 mm	31004	

Display Ref. 1882



Display Sobremesa
Table Display
Pres. Comptoir

∅	3	4	5	5	6	6	7	8	8	9	10
Pcs	4	4	5	5	5	5	4	2	2	4	4

Ref. 1882 - N° Art. 22661:

€

Display 37 - Ref. 1882



∅	4	4	5	5	6	6	8	8	10	10
Pcs	2	2	2	2	2	2	2	2	2	2

Ref. 4995 - N° Art. 22620:

€

Display 70 - Refs. 1882 - 1879 - 1883

BROCA, BROCA-CORONA, CORONA DIAMANTE **PORCELÁNICO**
PORCELAIN Diamond Core Bit & Drill Bit
 Foret, Foret-Trépan et Trépan Diamant **PORCELAINE**



Ref. 1882	∅	4	5	5	6	6	8	8	10
	Pcs	2	3	2	5	5	3	2	2
Ref. 1879	∅	5	6	6	8	8	10	12	14
	Pcs	5	3	3	2	2	2	1	1
Ref. 1883	∅	6	8	10	20	25	32	35	
	Pcs	1	1	1	1	1	1	1	1

Ref. 4995 - N° Art. 82239:

€

Especial Porcelánico
Special Porcelain
Spécial porcelaine

Ref. **1879**

BROCA-CORONA DIAMANTE PORCELÁNICO

Porcelain Diamond Core Bit
Foret-Trépan diamant PORCELAINE



Uso / Use / Usage

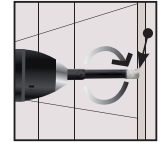
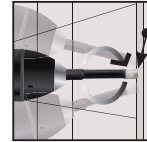
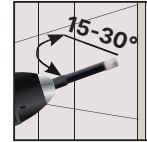

Porcelánico
Porcelain
Porcelaine

D mm	d mm	L mm	l mm		Nº Art.	€
5,00	8,30	68	10	1	56664	
6,00	8,30	68	10	1	56665	
8,00	8,30	80	10	1	56667	
10,00	8,30	80	10	1	56668	
12,00	8,30	80	10	1	56670	
14,00	8,30	80	10	1	56671	



Set 5 Pcs

Cont. Ø	Nº Art.	€
5-6-8-10-12 mm	57448	

Línea 33 cm - Ref. 1879



Ø	5	6	8	10	12	14
Pcs	3	3	3	3	3	3

Ref. 4995 - Nº Art. 71026: €



Ref. **1883**

CORONA DIAMANTE PORCELÁNICO

Porcelain Diamond Core Bit
Trépan diamant PORCELAINE

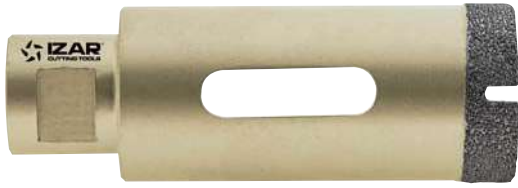

Video

Porcelánico
Porcelain
Porcelaine

Aplicación

Taladrado limpio de agujeros exactos en placas de piedra, azulejos, cerámicas, dekten y piedra artificial dura. Especial para Porcelánico.

Atención

Comenzar a taladrar con cuidado por un lado y redirigir poco a poco hacia un taladrado completo.

Consejo

Puede conseguir un mejor rendimiento con leves movimientos oscilantes a la corona mientras corta.

Diámetros más usuales

35 mm: Grifería
40 mm: Desagües electrodomésticos
50 mm: Desagües industriales
60 mm: Cajas eléctricas

Application

Clean drilling of exact and Sharp holes in stone plates, tiles, ceramics, dekten and hard artificial stone. Special for Porcelain.

Please note

Start drilling carefully edgewise and slowly continue with full drilling.

Tip

With small tilting movements of the core drill the cutting performance can be improved.

Most usual diameters

35 mm: Water Taps
40 mm: Appliances Pipes
50 mm: Industrial Pipes
60 mm: Electrical Boxes

Application

Perçage trous précision sur tôles pierre, carreaux de faïence, céramiques et dekten. Spécial pour porcelaine.

Attention

Commencer à percer doucement et rediriger petit à petit vers un perçage complet.

Conseil

Vous pouvez avoir une meilleure performance avec faibles mouvements variables sur le trépan dans la coupe.

Diamètres plus usuels

35 mm: Robinetterie
40 mm: Déversoirs ménage
50 mm: Déversoirs industriels
60 mm: Boîtes électriques

D mm	L mm	Rosca Thread Filet	N° Art.	€
6	63	M14	1 34506	
8	63	M14	1 34353	
10	63	M14	1 34507	
12	63	M14	1 34508	
14	63	M14	1 55532	
16	90	M14	1 81515	
18	90	M14	1 55533	
20	90	M14	1 55534	
25	90	M14	1 55535	
32	90	M14	1 55536	

D mm	L mm	Rosca Thread Filet	N° Art.	€
35	90	M14	1 34510	
40	90	M14	1 34511	
45	90	M14	1 55538	
50	90	M14	1 34512	
55	90	M14	1 55539	
60	90	M14	1 34513	
68	90	M14	1 55541	
75	90	M14	1 34516	
82	90	M14	1 55542	
110	90	M14	1 69797	



Mod. 00021

Husillo Mango Hexagonal disponible en [pag. 95](#)

Hex Shank Spindle available in [page 95](#)

Arbre queue hexagonal disponible à la [pag. 95](#)

Línea 1 m - Ref. 1883



∅	6	8	10	12	14	18	20	25	32	35	40	45	50
Pcs	1	1	1	1	1	1	1	1	1	1	1	1	1

Ref. 4995 - N° Art. 72145:

€



Ref. **1877**

BROCA GRANITO

Granite Drill Bit
Foret Granite



BlackGranite



Video

Granito
Granite
Granite

Piedra
Stone
Pierre

Mármol
Marble
Marbre

Silestone

- Ideal para piedras de todo tipo hasta granitos de gran dureza.
- Ideal for all types of stones, from general ones to hard granites.
- Idéal pour tous les types de pierres jusqu'aux granites difficiles à percer.

- El uso de refrigeración con agua permite una mayor eficiencia de corte y durabilidad. También apto en seco.
- Better performance and durability if cooled using water when drilling. Dry cutting also possible
- Le refroidissement à eau permet une meilleure efficacité de coupe et une meilleure durabilité. Coupe à sec également possible.

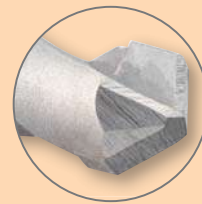

• **Forma de filo asimétrico.**

El rectificado asimétrico de la punta de metal duro reduce la resistencia al corte, permitiendo una perforación del material de trabajo con menor esfuerzo de torsión.

• **Asymmetric cutting edge shape.**

The asymmetric grinding of the carbide tip reduces cutting resistance, allowing the work material drilling with a lower torque.

• **Arête de coupe asymétrique.**

La réctification asymétrique de la pointe en carbure réduit la résistance à la coupure, permettant le perçage du matériau de travail avec une torsion plus faible.

D mm	L mm	l mm	d mm	RPM		Nº Art.	€
3,00	85	50	3,00	2000-2500	1	76539	
3,50	85	50	3,00	2000-2500	1	76540	
4,00	85	50	3,50	2000-2500	1	76543	
4,50	85	50	4,00	2000-2500	1	76544	
5,00	85	50	4,50	2000-2500	1	76545	
6,00	100	65	5,50	1500-2000	1	76547	
7,00	125	75	6,50	1500-2000	1	76548	
8,00	125	75	7,50	1000-1500	1	76549	
9,00	150	90	8,50	1000-1500	1	76550	
10,00	150	90	9,50	1000-1500	1	76553	



Display
69



29 cm

ø	4	4	5	5	6	6	8	8	10	10
Pcs	2	2	3	3	3	3	3	3	2	2

Ref. 4995 - Nº Art. 81880:

€

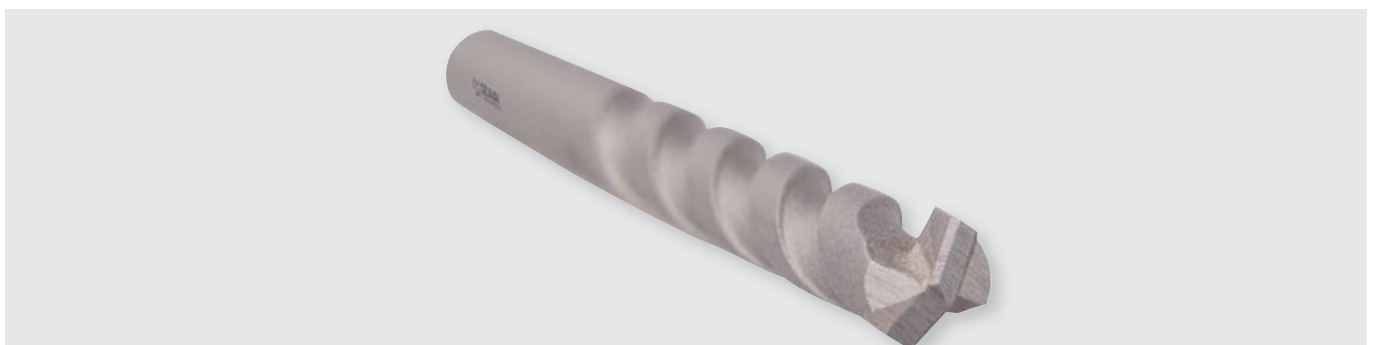

Una broca para TODOS los materiales

One Drill Bit for ALL Materials

Un foret pour TOUS les matériaux

Ref. **1876**

BROCA PUNTA METAL DURO MULTIPROPÓSITO

MultiPurpose Carbide Tipped Drill Bit
Foret pointe carbure Multifonction

New!



MULTIMAT



Video

- Hormigón**
Concrete
Béton
- Ladrillo**
Brick
Brique
- Cerámica**
Ceramics
Céramique
- Porcelánico Blando**
Soft Porcelain
Porcelaine tendre
- Aceros**
Steels
Aciers
- Madera**
Wood
Bois
- Plásticos**
Plastics
Plastiques

D mm	L mm	I mm		Nº Art.	€
3	70	35	1	25533	
4	75	40	1	25534	
5	85	50	1	25536	
6	100	65	1	25539	
8	120	70	1	25542	
10	120	70	1	25546	
12	150	90	1	25549	

D mm	L mm	I mm		Nº Art.	€
6	150	90	1	25540	
8	150	90	1	25543	
10	150	90	1	25548	



- Punta de metal duro con afilado exclusivo IZAR
 - Apta para trabajar con percusión (hormigón) y rotación (ladrillo, cerámica, chapa, madera y plásticos)
 - Canales amplios, mejor desahogo del polvo / viruta
 - Permite trabajo en seco, optimizado con refrigeración
 - Perforación con precisión
 - Geometría innovadora que permite una rápida perforación
 - Tratamiento superficial IZAR BLUE, evita la adherencia del polvo / viruta
- Carbide Tip with exclusive Sharpening
 - Suitable for working with Percussion (Concrete) & Rotation (Brick, Ceramics, Sheets, Wood & Plastic)
 - Wide Flutes, better dust / chip relief
 - Dry Running allowed, optimized with Cooling
 - Drilling with Precision
 - Innovative Geometry that allows Fast Drilling
 - IZAR BLUE Surface Treatment, prevents the adhesion of dust / chips
- Pointe carbure avec affûtage exclusif
 - Convient pour travailler avec percussion (béton) et rotation (brique, céramique, tôle, bois et plastique)
 - Goujure large, meilleur soulagement des poussières / copeaux
 - Travail à sec, optimisé avec réfrigération
 - Perçage avec précision
 - Géométrie innovante qui permet un perçage rapide
 - Traitement de surface IZAR BLUE, empêche l'adhérence des poussières / copeaux



Una broca para TODOS los materiales
 One Drill Bit for ALL Materials
 Un foret pour TOUS les matériaux



6 Sets

Nº Art.	€
53481	



Set 1876

Set 6 Pcs

Cont. Ø	Nº Art.	€
3-4-5-6-8-10 mm	70478	

Display 72 - Ref. 1876



ø	3	4	5	5	6	6	8	8	10	12
Pcs	5	5	5	5	5	5	5	5	5	5

Ref. 4995 - Nº Art. 40228: €

Display 09 - Refs. 1880 - 1836 - 1876

BROCAS PARED, VIDRIO, MULTIPROPÓSITO

Masonry, Glass, MultiPurpose Drill Bits
 Forets maçonnerie, verre, multifonction



Ref. 1880	ø	3 L60	4 L75	5 L85	6 L100	7 L100	8 L120	9 L120	10 L120	12 L150	14 L150
	Pcs	5	5	10	10	5	6	3	3	3	3
Ref. 1836	ø	3	4	4	5	5	6	6	8	8	10
	Pcs	5	3	2	3	2	3	2	3	2	5
Ref. 1876	ø	3	4	5	5	6	6	8	8	10	12
	Pcs	5	5	5	5	5	5	5	5	5	5

Ref. 4995 - Nº Art. 22410: €



Ref. **1821** New!

Broca Pared Pro 4Z+ Mango 3 Planos

3-Flat Shank 4Z+ Professional Concrete Drill Bit

Foret béton professionnel 4Z+ queue 3 plans



No patina - Extra Grip - Pas de glissement

- Punta centradora de Metal Duro de alto rendimiento
- Perforación precisa debido a las 4 puntas
- El mango de 3 planos evita el patinado
- Óptima evacuación del polvo que evita el calentamiento de la broca
- Más eficiente que una broca convencional
- High performance Carbide centering tip
- Precise drilling due to the 4 cutter point
- 3 Flat-shank for Extra Grip which prevents slipping
- Optimal dust evacuation that prevents the bit from heating up
- More efficient than a conventional drill bit
- Pointe de centrage en carbure de haut rendement
- Perçage précis grâce aux 4 pointes
- La queue à 3 plans évite le glissement
- Évacuation optimale de la poussière évitant le chauffage du foret
- Plus efficace qu'un foret conventionnel

Ref. **1821**

BROCA PUNTA METAL DURO PARED PRO 4Z+ MANGO 3 PLANOS

3-Flat Shank 4Z+ Professional Concrete Carbide Tipped Drill Bit

Foret pointe carbure béton professionnel 4Z+ queue 3 plans

New!



MD/HM
TCT



4 Z



Hormigón
Concrete
Béton

Hormigón Bloque
Concrete Block
Parpaing



D mm	L mm	I mm		Nº Art.	€
5	85	50	1	26220	
5,5	85	50	1	84585	
6	100	60	1	26221	
7	100	60	1	84586	
8	120	80	1	26285	
9	120	80	1	84587	
10	120	80	1	26287	
11	150	100	1	84588	
12	150	90	1	26360	
13	150	100	1	84589	
14	150	80	1	84590	
16	150	80	1	84591	

D mm	L mm	I mm		Nº Art.	€
5	150	100	1	84571	
6	150	100	1	84572	
8	200	150	1	84573	
10	200	150	1	84575	
12	200	150	1	84599	



Set 5 Pcs

D mm	Nº Art.	€
5, 6, 8, 10, 12	69406	



6 Sets

Nº Art.	€
69408	

Línea 33 cm - Ref. 1821

New!

ø	5	6	8	10	12
	Pcs	10	10	10	10

Ref. 4995 - Nº Art. 84075: €

Display 80 - Refs. 1821 - 1846



BROCAS PARED PRO
Concrete Pro Drill Bits
Forets béton Pro

Ref.	ø	12 L200	8 L400	10 L400	12 L400	14 L400	16 L400	18 L400	20 L400
Ref. 1846	Pcs	1	3	3	3	3	3	2	2
Ref. 1821	ø	12	14	16	5 L150	6 L150	8 L200	10 L200	12 L200
Ref. 1821	Pcs	5	5	5	5	5	5	3	2
Ref. 1821	ø	5	5	6	7	8	8	9	10
Ref. 1821	Pcs	10	5	5	5	5	5	5	5

Ref. 4995 - Nº Art. 85813: €

Ref. **1886**

BROCA PUNTA METAL DURO PARED PROFESIONAL

Professional Concrete Carbide Tipped Drill Bit
Foret pointe carbure béton professionnel





MD/HM
TCT



Hormigón
Concrete
Béton

Hormigón Bloque
Concrete Block
Parpaing

D mm	L mm	I mm		Nº Art.	€
3,0	60	35	1	30232	
4,0	75	45	1	18525	
5,0	85	40	1	18526	
5,5	85	40	1	23983	
6,0	100	55	1	18528	
6,5*	100	55	1	23984	
7,0	100	55	1	18529	
8,0	120	70	1	18531	
9,0	120	70	1	18532	
10,0	120	70	1	18534	
11,0	150	90	1	17858	
12,0	150	90	1	18535	
13,0	150	90	1	30234	
14,0	150	90	1	18537	
16,0	150	90	1	30235	

D mm	L mm	I mm		Nº Art.	€
5,0	150	80	1	30176	
6,0	150	80	1	30200	
8,0	200	130	1	30208	
10,0	200	130	1	30214	
12,0	200	130	1	30222	



* Diam. hasta fin de existencias / while stock lasts / jusqu'à la fin de stock

Línea 1 m - Ref. 1886



ø	3	4	5	6	7	8	9	10	12	14	16
Pcs	10	10	10	10	10	10	10	10	10	10	10

Ref. 4995 - Nº Art. 71100: €



Ref. **1846**

BROCA PUNTA METAL DURO PARED PRO EXTRA LARGA

Extra Long Professional Concrete Carbide Tipped Drill Bit
Foret pointe carbure béton professionnel extra-longue



MD/HM
TCT



Serie Extra Larga
Extra Long Series
Série extra-longue

Hormigón
Concrete
Béton

Hormigón Bloque
Concrete Block
Parpaing

D mm	L mm	I mm		Nº Art.	€
6	400	300	1	30202	
8	400	300	1	30212	
10	400	300	1	30216	
12	400	300	1	30227	
14	400	300	1	30233	
16	400	300	1	30237	
18	400	300	1	30207	
20	400	300	1	30225	
22	400	300	1	16474	
24	400	300	1	16475	
25	400	300	1	16476	

D mm	L mm	I mm		Nº Art.	€
8	600	450	1	76910	
10	600	450	1	30218	
12	600	450	1	30229	
14	600	450	1	30236	
16	600	450	1	30238	
18	600	450	1	16477	
20	600	450	1	16478	



Línea 1 m - Ref. 1846



ø	6	8	10	12	14	16	18	20	22	24	25	10	12	14	16	18	20
	L400	L400	L400	L400	L400	L400	L400	L400	L400	L400	L400	L600	L600	L600	L600	L600	L600
Pcs	2	2	2	2	2	2	2	1	1	1	1	2	2	2	2	2	1

Ref. 4995 - Nº Art. 72150: €

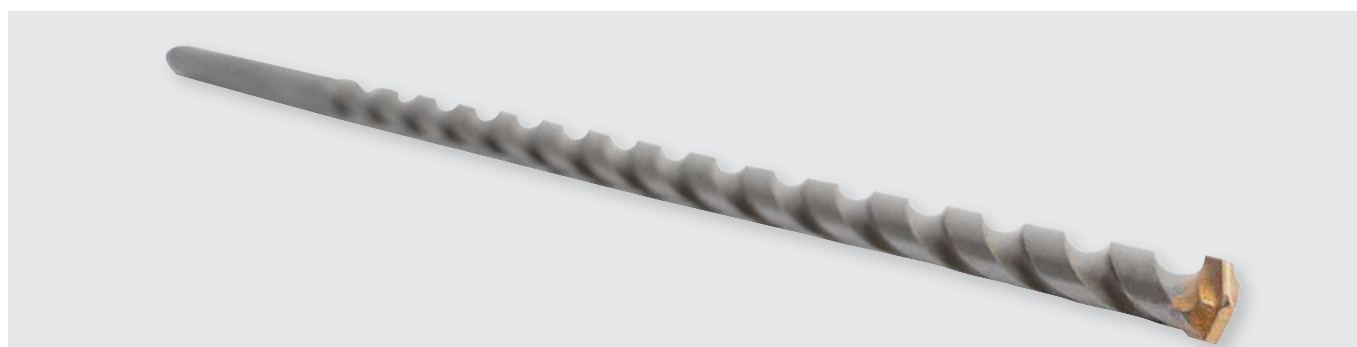

Display 07 - Refs. 1846 - 1886



Ref. 1846	∅	12	8	10	12	14	16	18	20		
	Pcs	L200	L400	L400	L400	L400	L400	L400	L400		
Ref. 1886	∅	10	12	14	16	5	6	8	10		
	Pcs	L120	L150	L150	L150	L150	L150	L200	L200		
Ref. 1886	∅	3	4	5	5	6	6	7	8	8	9
	Pcs	L60	L75	L85	L85	L100	L100	L100	L120	L120	L120

Ref. 4995 - N° Art. 22191: €

Display 52 Mixto PRO - Refs. 1886 - 1641 - 1004



BROCAS MULTI INOX + PARED PRO + MADERA PRO

Multi-Stainless + Concrete Pro + Wood Pro Drill Bits

Forets Multi INOX + béton pro + bois pro

Ref. 1886	∅	3	4	5	6	7	8	9	10	12	14
	Pcs	5	5	10	10	5	5	3	3	3	3
Ref. 1641	∅	3	3	4	4	5	5	6	6	8	10
	Pcs	3	2	3	2	3	2	3	2	5	5
Ref. 1004	∅	1	2	3	3,5	4	4,5	5	6	8	10
	Pcs	2	2	3	3	5	5	5	5	5	3

Ref. 4995 - N° Art. 68575: €

Display 23 - Refs. 1880 - 1886 - 1640 - 1899

JUEGOS CASSETTE MADERA Y CONSTRUCCIÓN

Wood & Construction Cassette Sets

Jeux cassette bois & construction



Constr. Madera Wood / Bois	Set 1485 - Ref. 1880 Pared Masonry / Béton 5 Pcs.	Set 1486 - Ref. 1886 Pared Pro Masonry Pro / Béton Pro 5 Pcs.	Set 1435 - Ref. 1640 Madera Wood / Bois 5 Pcs.	Set 1438 - Ref. 1640 Madera Wood / Bois 8 Pcs.
	Pcs	5	5	5
Constr.	Set 1488 - Ref. 1880 Pared Masonry / Béton 8 Pcs.	Set 1487 - Ref. 1886 Pared Pro Masonry Pro / Béton Pro 8 Pcs.	Set 1494 - Ref. 1890 SDS plus 4 Pcs.	
	Pcs	5	5	3

Ref. 4995 - N° Art. 22372: €



Sets. Ref. 1886



Set **1486**

5 Pcs

Cont. Ø	Nº Art.	€
4-5-6-8-10 mm	30220	



Set **1487**

8 Pcs

Cont. Ø	Nº Art.	€
3-4-5-6-7-8-9-10 mm	21653	

Línea 33 cm - 14S1

SETS BROCAS METAL, PARED PRO, PARED, MADERA

Metal, Concrete, Masonry, Wood Sets
Jeux Métal, Béton, Maçonnerie, Bois



	Metal Metal Métal	Pared Pro Concrete Béton	Pared Masonry Maçonnerie	Madera Wood Bois
Ref	Set 1462 - Ref. 1010	Set 1486 - Ref. 1886	Set 1485 - Ref. 1880	Set 1435 - Ref. 1640
Diam	2-3-4-5-6-8 mm	4-5-6-8-10 mm	4-5-6-8-10 mm	4-5-6-8-10 mm
Pcs.	5	5	5	5

Ref. 4995 - Nº Art. 72193: €

Línea 33 cm - 14S2

SETS BROCAS HORMIGÓN, PARED PRO, PARED

Concrete, Masonry Sets
Jeux Béton, Maçonnerie



	Hormigón Concrete Béton	Pared Pro Concrete Béton	Pared Masonry Maçonnerie
Ref	Set 1494 - Ref. 1899	Set 1487 - Ref. 1886	Set 1488 - Ref. 1880
Diam	5/6×110 + 8/10×160 mm	3-4-5-6-7-8-9-10 mm	3-4-5-6-7-8-9-10 mm
Pcs.	3	5	5

Ref. 4995 - Nº Art. 72194: €

Ref. **1880**

BROCA PUNTA METAL DURO PARED STANDARD

Standard MASONRY Carbide Tipped Drill Bit
Foret pointe carbure MAÇONNERIE standard



MD/HM
TCT



Ladrillo
Brick
Brique

D mm	L mm	l mm	d mm		Nº Art.	€	D mm	L mm	l mm	d mm		Nº Art.	€
3	60	30	2,5	1	18495		13	150	95	10,0	1	30180	
4	75	40	3,2	1	18496		14	150	95	10,0	1	18508	
5	85	50	4,0	1	18498		16	150	95	14,0	1	30184	
6	100	60	4,8	1	18499		18	160	105	16,0	1	30188	
7	100	60	5,2	1	18501		20	160	105	18,0	1	30190	
8	120	80	6,2	1	18502		22	160	105	19,0	1	30192	
9	120	80	7,5	1	18504		25	160	105	22,5	1	30194	
10	120	80	7,5	1	18505								
11	150	85	8,5	1	30178								
12	150	85	8,5	1	18507								



D mm	L mm	l mm	d mm		Nº Art.	€	D mm	L mm	l mm	d mm		Nº Art.	€
5	150	85	4,0	1	30174		6	200	135	4,8	1	30198	
6	150	85	4,8	1	30196		8	200	135	7,5	1	30211	
							10	200	135	8,5	1	30412	
							12	200	135	8,5	1	30224	
							14	200	135	12,0	1	30228	

Línea 1 m - Ref. 1880



ø	3	4	5	6	7	8	9	10	12	14
Pcs	10	10	10	10	10	10	10	10	10	10

Ref. 4995 - Nº Art. 71032: €



Display 08 - Ref. 1880



Ref. 1880	∅	16 L150	5 L150	6 L150	6 L200	8 L200	10 L200	12 L200	14 L200		
	Pcs	5	5	10	10	10	5	5	5		
	∅	3 L60	4 L75	5 L85	6 L100	7 L100	8 L120	9 L120	10 L120	12 L150	14 L150
	Pcs	10	10	10	10	10	10	5	5	5	5
Sets 1485 1488	∅	Set 1485 - Ref. 1880			Set 1488 - Ref. 1880			Set 1485 - Ref. 1880			
	Pcs	5			5			5			

Ref. 4995 - N° Art. 22311: €

Display 09 - Refs. 1880 - 1836 - 1876

BROCAS PARED, VIDRIO, MULTIPROPÓSITO

Masonry, Glass, MultiPurpose Drill Bits
Forets maçonnerie, verre, multifonction



Ref. 1880	∅	3 L60	4 L75	5 L85	6 L100	7 L100	8 L120	9 L120	10 L120	12 L150	14 L150
	Pcs	5	5	10	10	5	6	3	3	3	3
Ref. 1836	∅	3	4	4	5	5	6	6	8	8	10
	Pcs	5	3	2	3	2	3	2	3	2	5
Ref. 1876	∅	3	4	5	5	6	6	8	8	10	12
	Pcs	5	5	5	5	5	5	5	5	5	5

Ref. 4995 - N° Art. 22410: €

Display 51 - Refs. 1880 - 1640 - 1001

BROCAS METAL + PARED + MADERA

Metal + Masonry + Wood Drill Bits

Forets métal + maçonnerie + bois



Ref. 1880	∅	3	4	5	6	7	8	9	10	12	14
	Pcs	10	10	10	10	10	10	5	5	5	5
Ref. 1640	∅	3	4	5	6	8	9	10	12	14	16
	Pcs	10	10	10	10	10	5	5	5	5	5
Ref. 1001	∅	1	2	3	3,5	4	4,5	5	6	8	10
	Pcs	10	10	10	10	10	10	10	5	5	3

Ref. 4995 - N° Art. 68572:

€

Display 59 - Refs. 1880 - 1640 - 1002

BROCAS SPEED POINT + PARED + MADERA

Speed Point + Masonry + Wood Drill Bits

Forets speed point + maçonnerie + bois



Ref. 1880	∅	3	4	5	6	7	8	9	10	12	14
	Pcs	10	10	10	10	10	10	5	5	5	5
Ref. 1640	∅	3	4	5	6	8	9	10	12	14	16
	Pcs	10	10	10	10	10	5	5	5	5	5
Ref. 1002	∅	2	3	3,5	4	4,5	5	6	7	8	10
	Pcs	10	10	10	10	10	10	5	5	5	3

Ref. 4995 - N° Art. 70099:

€



Sets - Ref. 1880



Set **1485**

5 Pcs

Cont. Ø	Nº Art.	€
4-5-6-8-10 mm	30215	



Set **1488**

8 Pcs

Cont. Ø	Nº Art.	€
3-4-5-6-7-8-9-10 mm	30219	

Línea 33 cm - 14S1

SETS BROCAS METAL, PARED PRO, PARED, MADERA

Metal, Concrete, Masonry, Wood Sets
Jeux Métal, Béton, Maçonnerie, Bois



23 cm

	Metal Metal Métal	Pared Pro Concrete Béton	Pared Masonry Maçonnerie	Madera Wood Bois
Ref	Set 1462 - Ref. 1010	Set 1486 - Ref. 1886	Set 1485 - Ref. 1880	Set 1435 - Ref. 1640
Diam	2-3-4-5-6-8 mm	4-5-6-8-10 mm	4-5-6-8-10 mm	4-5-6-8-10 mm
Pcs.	5	5	5	5

Ref. 4995 - Nº Art. 72193: €

Línea 33 cm - 14S2

SETS BROCAS HORMIGÓN, PARED PRO, PARED

Concrete, Masonry Sets
Jeux Béton, Maçonnerie



26 cm

	Hormigón Concrete Béton	Pared Pro Concrete Béton	Pared Masonry Maçonnerie
Ref	Set 1494 - Ref. 1899	Set 1487 - Ref. 1886	Set 1488 - Ref. 1880
Diam	5/6x110 + 8/10x160 mm	3-4-5-6-7-8-9-10 mm	3-4-5-6-7-8-9-10 mm
Pcs.	3	5	5

Ref. 4995 - Nº Art. 72194: €

Ref. **1460**

SET MIXTO BROCAS

Drill Bit Mix Set
Jeu forets mix



9 Pcs

Cont. Ø	Nº Art.	€
3 Pcs Metal: 5-6-8 3 Pcs Madera/Wood/Bois: 5-6-8 3 Pcs Pared/Masonry/Béton 5-6-8	55610	



Ref. **1836**

BROCA VIDRIO

GLASS Drill Bit
Foret VERRE

¡NUEVO MODELO MEJORADO!
New improved model!
Nouveau modèle amélioré !



**MD
HM**
Carbure



Vidrio
Glass
Verre

Cerámica
Ceramics
Céramique

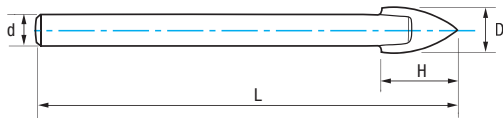

D mm	d mm	L mm	H mm	Art.	Nº Art.	€
3	2,80	70	6	1	30239	
4	3,20	75	8	1	30240	
5	4,00	80	10	1	30241	
6	4,80	85	12	1	30242	
8	6,30	90	16	1	30243	
10	7,50	100	20	1	30244	



New!

4 Pcs

Cont. Ø	Nº Art.	€
4-5-6-8 mm	59168	



Pag. 342

Ref. **1834**

New!



BROCA VIDRIO Y AZULEJO 4Z+
4Z+ Glass and Soft Tiles Drill Bit
Foret verre et carreau 4Z+

Línea 33 cm - Ref. 1836



Ø	3	4	5	6	8	10
Pcs	5	5	5	5	5	5
Ref. 4995 - Nº Art. 71037:						€

Ref. **1699**

PUNTERO MARCADOR

Pencil Scriber
Traçeur carbure



**MD/HM
TCT**



Aceros
Steel
Aciers

Madera
Wood
Bois

Cerámica
Ceramics
Céramique

Nº Art.	€
1 18856	



CORONAS

Hole Saws

Trépan

Ref. **1645**

SIERRA CORONA METAL / MADERA

METAL / WOOD Hole Saw
Trépan MÉTAL / BOIS



HSSE
8% Co



INOX
Stain-
less

Bimetal

Aceros
<850 N/mm²
Steel / Aciers

INOX
Stainless Steel
Acier INOX

TPI
4-6



Fundición
Cast Iron
Fonte

Cobre
Copper
Cuivre

Madera
Wood
Bois



D mm	L mm	P.G.	Pulgadas Inches / Pouces		Nº Art.	€	D mm	L mm	P.G.	Pulgadas Inches / Pouces		Nº Art.	€
14	37		9/16	1	20094		57	37		2 1/4	1	30325	
16	37	9	5/8	1	20104		59	37	48	2 5/16	1	30326	
17	37		11/16	1	21321		60	37		2 3/8	1	30328	
19	37	11	3/4	1	30250		63	37		2 31/64	1	18801	
20	37		25/32	1	30258		64	37		2 1/2	1	30329	
21	37	14	13/16	1	30260		65	37		2 9/16	1	30331	
22	37	16	7/8	1	30265		67	37		2 5/8	1	30388	
23	37		14/16	1	30268		68	37		2 11/16	1	30391	
24	37		15/16	1	30274		70	37		2 3/4	1	30392	
25	37		1	1	30282		73	37		2 7/8	1	30393	
27	37		1 1/16	1	30287		76	37		3	1	30394	
29	37	21	1 1/8	1	30289		79	37		3 1/8	1	30395	
30	37		1 3/16	1	30293		83	37		3 1/4	1	30396	
32	37		1 1/4	1	30297		86	37		3 3/8	1	30397	
33	37		1 5/16	1	30301		89	37		3 1/2	1	30398	
35	37		1 3/8	1	30302		92	37		3 5/8	1	30399	
37	37	29	1 7/16	1	30304		95	37		3 3/4	1	30400	
38	37		1 1/2	1	30307		98	37		3 7/8	1	30401	
40	37		1 9/16	1	30308		102	37		4	1	30402	
41	37		1 5/8	1	30310		105	37		4 1/8	1	52485	
43	37		1 11/16	1	30313		114	37		4 1/2	1	30403	
44	37		1 3/4	1	30315		121	37		4 3/4	1	30404	
46	37		1 13/16	1	30316		127	37		5	1	30405	
48	37	36	1 7/8	1	30318		140	37		5 1/2	1	30406	
50	37		1 31/32	1	18800		152	37		6	1	30407	
51	37		2	1	30320		160	37		6 5/16	1	24475	
52	37		2 1/16	1	30321		210	37		8 9/32	1	24606	
54	37	42	2 1/8	1	30323								

Husillos y Adaptadores: Pag. 284 / Spindles & Adaptors: Pag. 284 / Arbres et Adaptateurs: Pag. 284



Línea 1 m - Ref. 1645



∅	16	19	20	22	24	25	27	29	30	32	35	51	64	65	H3A	H4A
Pcs	2	2	2	2	2	2	2	2	2	2	2	2	2	2	2	2

Ref. 4995 - N° Art. 71040: €

Display 19 - Ref. 1645



∅	16	19	20	22	24	25	27	29	30	32	35
Pcs	2	2	2	2	2	2	2	2	2	2	2
Ref. 1645	∅	38	40	41	43	44	48	51	54		
	Pcs	2	2	2	2	2	2	2	2	2	
∅	60	65	68	70	76	79					
Pcs	2	2	2	2	2	2					
Ref. 1645 1646	∅	83	89	102	H3A	H4A	BR 90	BR 110			
	Pcs	1	1	1	3	3	3	3			

Ref. 4995 - N° Art. 22220: €



Mod. 1
7 Pcs

Básico
Basic
Essentiel



Cont. Ø mm	Nº Art.	€
25-35-43-51-64-H3A-H4A	18232	

Mod. 2
14 Pcs

Completo
Complete
Complet



Cont. Ø mm	Nº Art.	€
19-22-25-32-35-38-43-51-57-60-64-76 H3A-H4A	18234	

Mod. 3
12 Pcs

Electricista
Electrician
Electricien



Cont. Ø mm	Nº Art.	€
16-20-25-32-40-43-51-60-63-65-H3A-H4A	18235	

Mod. 4
8 Pcs

Básico 2
Basic 2
Essentiel 2



Cont. Ø mm	Nº Art.	€
16-20-25-32-40-51-H3A-H4A	58617	

Mod. 5
11 Pcs

Electricista 2
Electrician 2
Electricien 2



Cont. Ø mm	Nº Art.	€
16-20-27-32-40-43-48-51-64-H3A-H4A	58618	

Mod. 6
8 Pcs

Electricista 3
Electrician 3
Electricien 3







Cont. Ø mm	Nº Art.	€
22-35-51-57-68-76-H3A-H4A	66889	

Ref. **1647**



CORONA MULTIPRO

MULTIPRO Hole Saw
Trépan MULTIPRO



Diente MD Carbide Tipped Dent Carbure		 Ceramic	Meta- cristalo
		Fibra Vidrio Fiberglass Fibre de verre	DM MDF

Aceros Steel Aciers	Plásticos Plastics Plastiques	Madera Wood Bois	Ladrillo Brick Brique	Cerámica Ceramics Céramique
----------------------------------	--	-------------------------------	------------------------------------	--

D mm	L mm	Pulgadas Inches / Pouces	Z		Nº Art.	€	D mm	L mm	Pulgadas Inches / Pouces	Z		Nº Art.	€
16	57	5/8	1	1	31855		65	57	2 3/16	3	1	30710	
19	57	3/4	1	1	30691		67	57	2 5/8	3	1	30711	
20	57	25/32	1	1	30692		68	57	2 11/16	3	1	30712	
22	57	7/8	1	1	30693		70	57	2 3/4	3	1	30713	
24	57	15/16	1	1	31856		73	57	2 7/8	3	1	30714	
25	57	1	1	1	30694		76	57	3	4	1	30715	
27	57	1 1/16	1	1	30695		79	57	3 1/8	4	1	30716	
29	57	1 1/8	1	1	30696		83	57	3 1/4	4	1	30717	
30	57	1 3/16	1	1	30697		86	57	3 3/8	4	1	30718	
32	57	1 1/4	1	1	30698		89	57	3 1/2	4	1	30719	
35	57	1 3/8	1	1	30699		92	57	3 5/8	4	1	30720	
38	57	1 1/2	1	1	30700		95	57	3 3/4	4	1	30721	
40	57	1 9/16	2	1	30701		98	57	3 7/8	4	1	30722	
41	57	1 5/8	2	1	30702		102	57	4	5	1	30723	
43	57	1 11/16	2	1	31857		105	57	4 1/8	5	1	30724	
44	57	1 3/4	2	1	30703		108	57	4 1/4	5	1	30725	
48	57	1 7/8	2	1	30704		111	57	4 3/8	5	1	30726	
51	57	2	2	1	30705		114	57	4 1/2	5	1	30727	
54	57	2 1/8	2	1	30706		121	57	4 3/4	5	1	30728	
57	57	2 1/4	2	1	30707		127	57	5	5	1	30729	
60	57	2 3/8	3	1	30708		140	57	5 1/2	5	1	30730	
64	57	2 1/2	3	1	30709		152	57	6	5	1	30731	
							160	57	6 5/16	5	1	30732	



Husillos y Adaptadores: Pag. 284 / Spindles & Adaptors: Pag. 284 / Arbres et Adaptateurs: Pag. 284

- **Recomendado para terrazas de madera y tarimas sintéticas. Por ejemplo, en colocación de luces de suelo.**
- **Highly recommended for open terrace flooring, both wood and synthetic, e.g. on ground light installations.**
- **Recommandé pour les terrasses en bois et les terrasses synthétiques. Par exemple, lors de l'installation de lumières au sol.**



Línea 1 m - Ref. 1647



∅	25	29	30	35	40	51	60	67	68	73	76	H3C	H4C	BRC 110
Pcs	2	2	2	2	1	1	1	1	1	1	1	3	3	3

Ref. 4995 - N° Art. 72151: €

Display 60 - Refs. 1647 - 1646



Ref. 1647	∅	16	19	20	22	24	25	27	29	30	32	35
	Pcs	2	2	2	2	2	2	2	2	2	2	2
Ref. 1647	∅	38	40	41	43	44	48	51	54			
	Pcs	2	2	2	1	1	1	1	1			
Ref. 1646	∅	60	65	68	70	76	79					
	Pcs	1	1	1	1	1	1					
Ref. 1647	∅	83	89	102	H3C	H4C	BRC 110	BRC 110				
	Pcs	1	1	1	3	3	3	3				

Ref. 4995 - N° Art. 32965: €



Ref. **1661**

SIERRA CORONA DIENTE MD INTEGRAL

Carbide Teeth Core Drill
Trépan denture carbure

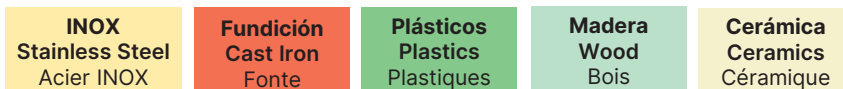
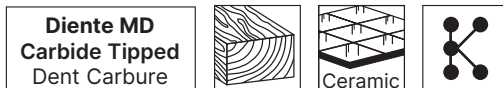

D mm	L mm	Pulgadas Inches / Pouces		Nº Art.	€
19	31	3/4	1	34311	
22	31	7/8	1	34312	
25	31	1	1	34313	
29	31	1 1/8	1	34314	
32	31	1 1/4	1	34315	
35	31	1 3/8	1	34316	
38	31	1 1/2	1	34317	
44	31	1 3/4	1	34318	
48	31	1 7/8	1	34319	
51	31	2	1	34320	
54	31	2 1/8	1	34321	
57	31	2 1/4	1	34322	
60	31	2 3/8	1	34323	
64	31	2 1/2	1	34324	
67	31	2 5/8	1	36831	
70	31	2 3/4	1	34325	
76	31	3	1	34326	
83	31	3 1/4	1	34327	
86	31	3 3/8	1	34328	
89	31	3 1/2	1	34329	
95	31	3 3/4	1	34330	
102	31	4	1	34331	



Husillos y Adaptadores: Pag. 284 / Spindles & Adaptors: Pag. 284 / Arbres et Adaptateurs: Pag. 284







Ref. **1662**

CORONA POLVO MD ELECTRODEPOSITADO

Electrodeposited Carbide Powder Core Drill Bit
Trépan Poudre carbure électrodéposé



Polvo MD Carbide Powder Poudre Carbure	 Ceramic	 Kevlar
 Fibra Vidrio Fiberglass Fibre de verre	 Vidrio Glass Verre	Ladrillo Brick Brique
Cerámica Ceramics Céramique		

D mm	L mm	Pulgadas Inches / Pouces		Nº Art.	€
16	36	5/8	1	34289	
19	36	3/4	1	34290	
20	36	25/32	1	34291	
22	36	7/8	1	34292	
25	36	1	1	34293	
29	36	1 1/8	1	34294	
32	36	1 1/4	1	34295	
35	36	1 3/8	1	34296	
38	36	1 1/2	1	34297	
44	36	1 3/4	1	34298	
48	36	1 7/8	1	34299	
51	36	2	1	34300	
54	36	2 1/8	1	34301	
57	36	2 1/4	1	34302	
60	36	2 3/8	1	34303	
64	36	2 1/2	1	34304	
70	36	2 3/4	1	34305	
76	36	3	1	34306	
83	36	3 1/4	1	34307	
86	36	3 3/8	1	34308	
95	36	3 3/4	1	34309	
102	36	4	1	34310	



Husillos y Adaptadores: Pag. 284 / Spindles & Adaptors: Pag. 284 / Arbres et Adaptateurs: Pag. 284



Ref. **1646**

HUSILLOS Y BROCAS CORONAS

Hole Saw Spindles & Drill Bits
Arbres et forets trépan



HSS

Mod.	d mm	Corona Hole Saw Trépan mm	Rosca Thread Filetage		Nº Art.	€
H3A	9,52	14-30	1/2×20 UNF	1	19602	
H4A	9,52	32-210	5/8×18 UNF	1	19603	

MD/HM TCT

Mod.	d mm	Corona Hole Saw Trépan mm	Rosca Thread Filetage		Nº Art.	€
H3C	9,52	14-30	1/2×20 UNF	1	39848	
H4C	9,52	32-210	5/8×18 UNF	1	39849	

MD/HM TCT

New!

New!

Mod.	d mm	Corona Hole Saw Trépan mm	Rosca Thread Filetage		Nº Art.	€
H3S	SDS plus	14-30	1/2×20 UNF	1	13724	
H4S	SDS plus	32-210	5/8×18 UNF	1	13725	



Mod.	D mm	L mm		Nº Art.	€
BR 90	6,35	90	1	19605	
BR 110	6,35	110	1	30019	
BRC 110	7,00	110	1	39850	

Ref. **1642**

ALARGADOR

Extension
Rallonge



Cap. mm	d mm	L mm		Nº Art.	€
9,52	11,00	300	1	69878	



ELECCIÓN HUSILLOS Y BROCAS CORONAS

Hole Saw Spindles & Drill Bits Choice

Choix des arbres et forets trépan

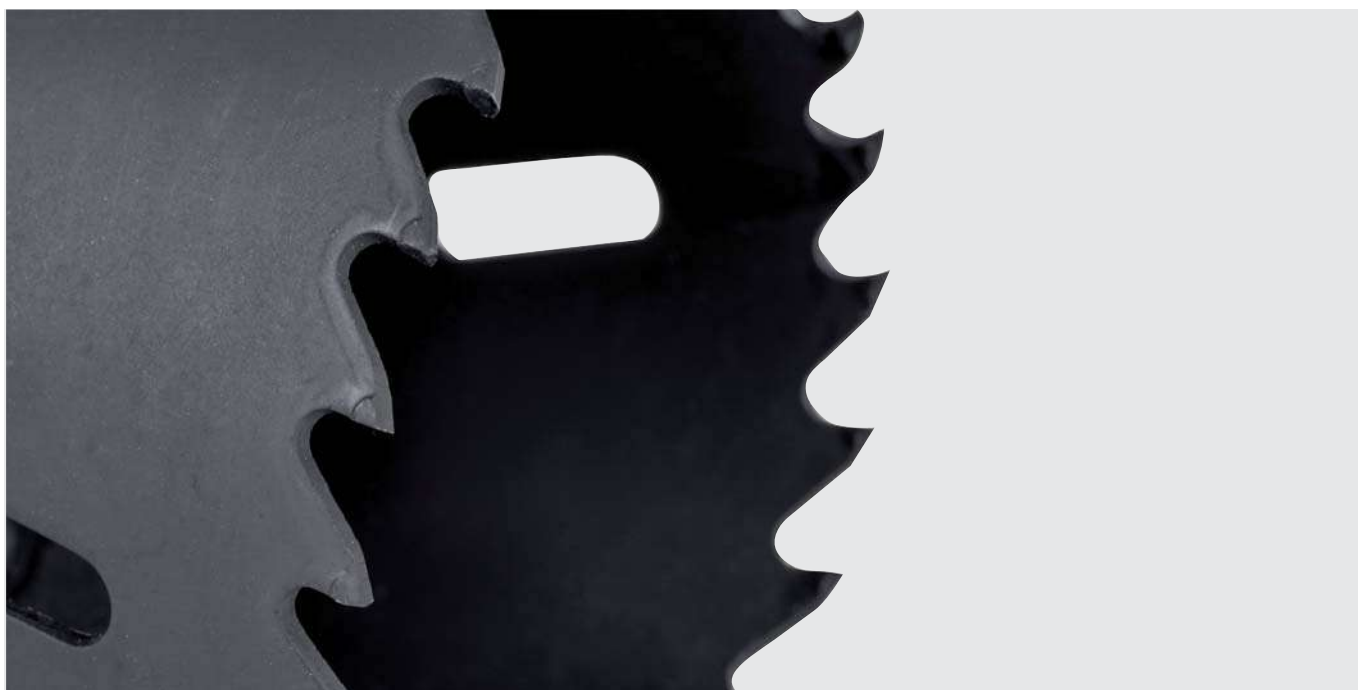
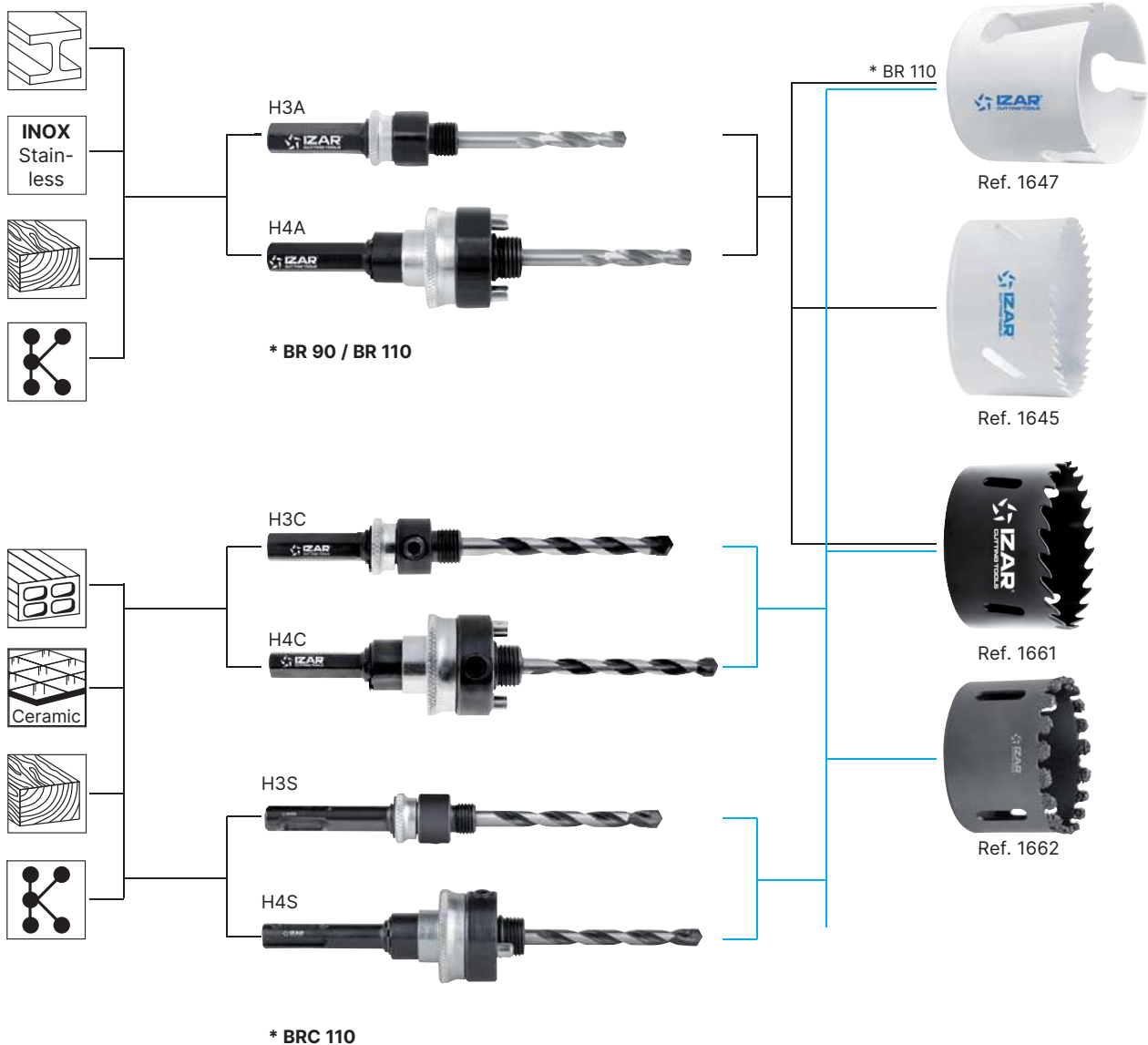

Ref. **1860**

CORONA DIAMANTE HORMIGÓN

CONCRETE Diamond Core Bit

Trépan diamant BÉTON

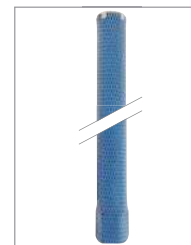

Hormigón Reforzado
Reinforced Concrete
Béton armé

Hormigón
Concrete
Béton

Hormigón Bloque
Concrete Block
Parpaing



D mm	Rosca Thread Filet	L mm	Nº Segmentos	Alto Height Haut Segmento mm	Largo Length Longueur Segmento mm	Ancho Width Largeur Segmento mm	Kw*		Nº Art.	€
32	1" 1/4	450	3	9	24	4	0,7>1,2	1	34333	
42	1" 1/4	450	4	9	24	4	0,7>1,2	1	34334	
52	1" 1/4	450	5	9	24	4	0,7>1,2	1	34335	
62	1" 1/4	450	6	9	24	4	0,7>1,2	1	34336	
72	1" 1/4	450	6	9	24	4	0,7>1,2	1	34337	
82	1" 1/4	450	7	9	24	4	1,2>2,3	1	34338	
92	1" 1/4	450	8	9	24	4	1,2>2,3	1	34339	
102	1" 1/4	450	9	9	24	4	1,2>2,3	1	34340	
112	1" 1/4	450	9	9	24	4	1,2>2,3	1	34341	
122	1" 1/4	450	10	9	24	4	1,2>2,3	1	34342	
127	1" 1/4	450	11	9	24	4	1,2>2,3	1	34332	
132	1" 1/4	450	11	9	24	5	1,2>2,3	1	34343	
142	1" 1/4	450	12	9	24	5	1,2>2,3	1	34344	
152	1" 1/4	450	12	9	24	5	1,2>2,3	1	34357	
162	1" 1/4	450	12	9	24	5	2,3>3,9	1	34345	
172	1" 1/4	450	13	9	24	5	2,3>3,9	1	34346	
182	1" 1/4	450	13	9	24	5	2,3>3,9	1	34347	
200	1" 1/4	450	15	9	24	5	2,3>3,9	1	34349	
225	1" 1/4	450	15	9	24	5	2,3>3,9	1	34350	
250	1" 1/4	450	16	9	24	5	2,3>3,9	1	34351	
300	1" 1/4	450	17	9	24	5	2,3>3,9	1	34352	

*Aplicar esta potencia y usar mucha agua para un rendimiento óptimo de la corona

*Use this power and plenty of water for an optimum performance of the core bit

*Appliquez cette puissance et utilisez de l'eau pour rendement optimale des trépan

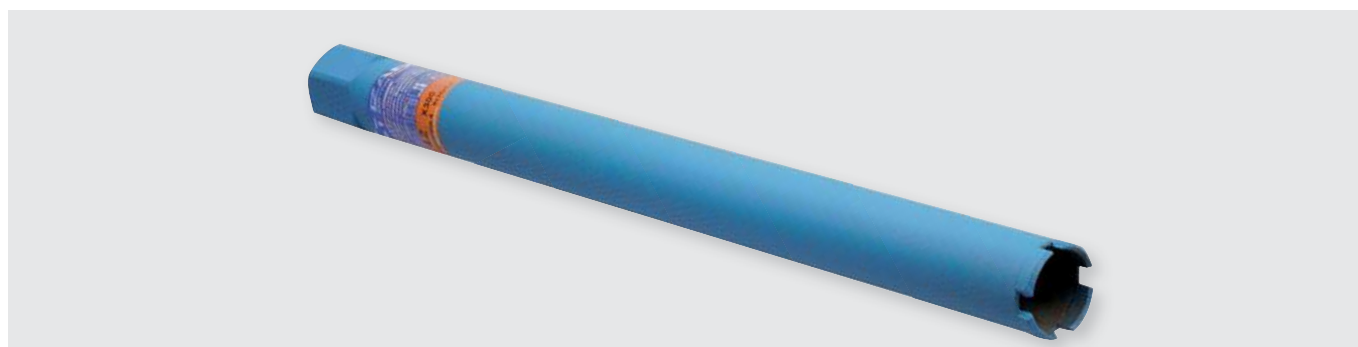

DISCOS DIAMANTE

Diamond Cutting Blades

Disques diamant

CUADRO USO DISCOS DIAMANTE

Diamond Disc Use Table

Tableau utilisation disques diamant

		Ref. 1851	Ref. 1852	Ref. 1853	Ref. 1854	Ref. 1855	Ref. 1857	Ref. 1858	Ref. 1861	Ref. 1862	Ref. 1863	Ref. 1864
<p>● Ideal - Ideal - Idéal</p> <p>◐ Adecuado - Suitable - Convenable</p> <p>○ Possible - Possible</p>												
	Hormigón Reforzado Reinforced Concrete Béton armé				●							
	Hormigón Seco Dry Concrete Béton sec	○	◐		●			◐				
	Hormigón Duro Hard Concrete Béton dur		○		●			◐				
	Hormigón Blando Soft Concrete Béton tendre	○	◐			◐						
	Hormigón Universal Universal Concrete Béton universel	◐	●		●		●	●	◐			
	Hormigón Silex Flint Concrete Béton silex						◐		○			
	Ladrillo Brick Brique	○	◐									
	Granito Duro Hard Granite Granite dur			◐	◐					●	◐	●
	Granito Medio Medium Granite Granite moyen		○					○			●	
	Granito Blando Soft Granite Granite tendre	○	◐					◐				
	Mármol Marble Marbre									●		
	Piedra Natural / Dura Natural / Hard Stone Pierre naturelle / Dure				○					○	○	
	Asfalto, Abrasivos Asphalt, Abrasives Asphalte, Abrasifs					●						
	Porcelánico, Gres, Azulejo Duro Porcelain, Stoneware, Hard Tile Porcelaine, Céramique, Carreau dur			●								

Ref. **1851**

SEGMENTADO RÁPIDO OBRA GENERAL

General Works **Fast** Segmented
Segmenté **rapide** général travaux



Hormigón Universal
Universal Concrete
Béton universel

Hormigón Seco
Dry Concrete
Béton sec

Hormigón Blando
Soft Concrete
Béton tendre

Granito Blando
Soft Granite
Granite tendre

Ladrillo
Brick
Brique

D mm	d1 mm	Nº Segmentos	Alto Height Haut Segmento mm	Ancho Width Largeur Segmento mm	Grosor Acero Steel Thickness Épaisseur acier mm	Max R.P.M.		Nº Art.	€
115	22,23	8	12	2,40	1,4	13300	1	60720	
125	22,23	9	12	2,40	1,4	12250	1	60722	
180	22,23	14	12	2,60	1,6	8500	1	67886	
230	22,23	16	12	2,80	1,8	6650	1	60723	
300	25,40	22	12	3,20	2,2	6400	1	60724	
350	25,40	24	12	3,20	2,2	5500	1	60725	



Ref. **1852**

SEGMENTADO LÁSER PROFESIONAL ALTO RENDIMIENTO

Long Life Professional Segmented Laser
Professionnel segmenté laser **haut rendement**



Hormigón Universal
Universal Concrete
Béton universel

Hormigón Seco
Dry Concrete
Béton sec

Hormigón Duro
Hard Concrete
Béton dur

Granito Medio
Medium Granite
Granite moyen

Granito Blando
Soft Granite
Granite tendre

Ladrillo
Brick
Brique

D mm	d1 mm	Nº Segmentos	Alto Height Haut Segmento mm	Ancho Width Largeur Segmento mm	Grosor Acero Steel Thickness Épaisseur acier mm	Max R.P.M.		Nº Art.	€
115	22,23	9	10	2,20	1,4	13300	1	64078	
125	22,23	10	10	2,20	1,4	12250	1	60729	
150	22,23	12	10	2,20	1,4	10200	1	60730	
180	22,23	14	10	2,40	1,6	8500	1	68880	
230	22,23	16	10	2,60	1,8	6650	1	60731	
300	20,00	20	10	3,00	2,2	6400	1	68883	
350	20,00	20	10	3,20	2,4	5500	1	68889	
350	25,40	23	10	3,20	2,4	5500	1	68890	



Ref. **1858**

TURBO OBRA GENERAL

General Works Turbo
Général travaux turbo

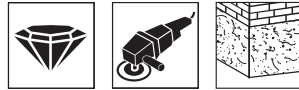

Hormigón Universal
Universal Concrete
Béton universel

Hormigón Seco
Dry Concrete
Béton sec

Hormigón Duro
Hard Concrete
Béton dur

Granito Medio
Medium Granite
Granite moyen

Granito Blando
Soft Granite
Granite tendre



D mm	d1 mm	Nº Segmentos	Alto Height Haut Segmento mm	Ancho Width Largeur Segmento mm	Grosor Acero Steel Thickness Épaisseur acier mm	Max R.P.M.		Nº Art.	€
115	22,23	9	10	2,20	1,4	13300	1	64080	
125	22,23	10	10	2,20	1,4	12250	1	60726	
150	22,23	12	10	2,20	1,4	10200	1	60727	
180	22,23	14	10	2,40	1,6	8500	1	69565	
230	22,23	16	10	2,60	1,8	6650	1	60728	



Ref. **1854**

SOLDADO LÁSER FORMA N

N Form Laser Welded
Soudé laser forme N

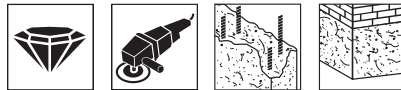

Hormigón Reforzado
Reinforced Concrete
Béton armé

Hormigón Seco
Dry Concrete
Béton sec

Hormigón Duro
Hard Concrete
Béton dur

Hormigón Universal
Universal Concrete
Béton universel

Granito Duro
Hard Granite
Granite dur

Piedra Natural
Natural Stone
Pierre naturelle



D mm	d1 mm	Nº Segmentos	Alto Height Haut Segmento mm	Ancho Width Largeur Segmento mm	Grosor Acero Steel Thickness Épaisseur acier mm	Max R.P.M.		Nº Art.	€
125	22,23	10	10	2,20	1,4	12250	1	60740	
180	22,23	14	10	2,40	1,6	8500	1	68895	
230	22,23	15	10	2,60	1,8	6650	1	60741	
300	25,40	20	10	3,00	2,2	6400	1	60742	
350	25,40	23	10	3,00	2,2	5500	1	60743	



Ref. **1853**

TURBO PORCELÁNICO

PORCELAIN Turbo
Turbo PORCELAINE



Porcelánico, Gres, Azulejo Duro
Porcelain, Stoneware, Hard Tile
Porcelaine, Céramique, Carreau dur

Granito Duro
Hard Granite
Granite dur

D mm	d1 mm	Nº Segmentos	Alto Height Haut Segmento mm	Ancho Width Largeur Segmento mm	Grosor Acero Steel Thickness Épaisseur acier mm	Max R.P.M.		Nº Art.	€
115	22,23	Continuo	11	1,30	1,0	13300	1	60732	
125	22,23	Continuo	11	1,30	1,0	12250	1	60739	
230	22,23	Continuo	11	1,50	1,2	6650	1	66552	



Ref. **1855**

SOLDADO LÁSER ASFALTO

ASPHALT Laser Welded
Soudé Laser ASPHALTE



Asfalto, Abrasivos
Asphalt, Abrasives
Asphalte, Abrasifs

Hormigón Blando
Soft Concrete
Béton tendre

Gran protección del segmento para evitar el corte inferior
No undercutting by strong wedge protection
Forte protection du ségment pour éviter la coupe inférieure.

D mm	d1 mm	Nº Segmentos	Alto Height Haut Segmento mm	Ancho Width Largeur Segmento mm	Grosor Acero Steel Thickness Épaisseur acier mm	Max R.P.M.		Nº Art.	€
300	25,40	18	10	3,20	2,2	6400	1	60744	
350	25,40	21	10	3,20	2,2	5500	1	60745	
400	25,40	24	10	3,40	2,4	4800	1	60747	



Ref. **1861**

HORMIGÓN FORMA DOBLE COPA

Double Rowed Cup Form Concrete
Béton forme double coupe



Hormigón Universal
Universal Concrete
Béton universel

Hormigón Silex
Flint Concrete
Béton Silex



D mm	d1 mm	Nº Segmentos	Alto Height Haut Segmento mm	Ancho Width Largeur Segmento mm	Grosor Acero Steel Thickness Épaisseur acier mm	Max R.P.M.		Nº Art.	€
115	22,23	12	8	5,00	3,0	13300	1	69473	
125	22,23	14	8	5,00	3,0	12250	1	69475	
180	22,23	28	8	5,00	3,0	8500	1	69477	



Ref. **1857**

TOP HORMIGÓN FORMA COPA Y ALTO RENDIMIENTO

Long Life Y Cup Form Concrete
Top béton forme coupe Y haut rendement



Hormigón Universal
Universal Concrete
Béton universel

Hormigón Silex
Flint Concrete
Béton Silex



Segmentos auto-afilados, superficie fina, tolerancia precisa, eficiente extracción del polvo
Self-sharpened segments, smooth surface, accurate tolerance, efficient dust exhausting
Ségments auto-affûtés, Surface fine, tolerance précise, extraction efficace de la poussière

D mm	d1 mm	Nº Segmentos	Grosor Acero Steel Thickness Épaisseur acier mm	Max R.P.M.		Nº Art.	€
115	22,23	8	3,0	13300	1	60749	
125	22,23	8	3,0	12250	1	60750	
180	22,23	12	3,0	8500	1	64082	



Ref. **1864**

GRANITO FORMA COPA "Y" DE ALUMINIO

Aluminium Cup Wheel for **Granite**
Granite forme coupe "Y" aluminium

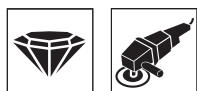

Granito Duro
Hard Granite
Granite Dur

Cuerpo de aluminio, filo amolado fino
Aluminium body, smooth edge grinding
Corps en aluminium, filet meulé fin

D mm	d1 mm	Alto Height Haut Segmento mm	Ancho Width Largeur Segmento mm	Grosor Acero Steel Thickness Épaisseur acier mm	Max R.P.M.		Nº Art.	€
100	22,23	20	7,30	5,5	14500	1	69487	



Ref. **1862**

TURBO GRANITO / MÁRMOL

Turbo Granite / **Marble**
Turbo granite / **marbre**

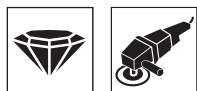

Granito Duro
Hard Granite
Granite dur

Mármol
Marble
Marbre

Piedra Dura
Hard Stone
Pierre dure

Forma en ola, no descascarilla el material
Wave shape, no wobbling during cutting
Forme vaguee, matériel sans décortilage

D mm	d1 mm	Alto Height Haut Segmento mm	Ancho Width Largeur Segmento mm	Grosor Acero Steel Thickness Épaisseur acier mm	Max R.P.M.		Nº Art.	€
115	22,23	7	2,20	1,2	13300	1	69479	
230	22,23	8	2,60	1,8	6650	1	69481	



Ref. **1863**

LÁSER CANTERO

Laser Quarry
Laser carrière

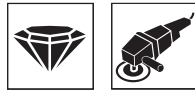

Granito Duro
Hard Granite
Granite dur

Granito Medio
Medium Granite
Granite moyen

Piedra Dura
Hard Stone
Pierre dure

Corte estable y gran rendimiento
Stable cutting high performance
Coupe stable et haute performance

D mm	d1 mm	Nº Segmentos	Alto Height Haut Segmento mm	Ancho Width Largeur Segmento mm	Grosor Acero Steel Thickness Épaisseur acier mm	Max R.P.M.		Nº Art.	€
230	22,23	15	12	3,20	2,2	6650	1	69485	



Ref. **1849**

AMARRE RÁPIDO AMOLADORA

Quick Lock Grinding Tool
Attachement rapide meuleuse



Mod.	Nº Art.	€
1	55946	



New!

6 Pcs

Nº Art.	€
24140	



Ref. **8309**

CUTER HOJA PARTIBLE 9 MM

9 mm Snap-Off Blade Box Cutter
Couteau à lames rétractables 9 mm



MOD. 9

Zamak
5



Mod.	Hoja Blade / Lame mm	€	Nº Art.
9	9	1	34238

Ref. **8331**

CUCHILLAS REPUESTO
Spare Blades - Lames de rechange

Mod.	Hoja Blade / Lame mm	€	Nº Art.
9	9	10	34241

Cúter con cuerpo metálico con mecanismo de bloqueo y almacén para cuchillas de repuesto. Incluye 3 cuchillas.

Box Cutter with metal body, locking mechanism and storage for spare blades. Includes 3 blades.

Couteau à lames avec corps en métal, mécanisme de verrouillage et dépôt pour les lames de rechange. Comprend 3 lames.

Ref. **8318**

CUTER HOJA PARTIBLE 18 MM

18 mm Snap-Off Blade Box Cutter
Couteau à lames rétractables 18 mm



New! MOD. 18-ERG



Mod.	Hoja Blade / Lame mm	€	Nº Art.
18-ERG	18	1	83359

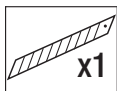

- Cuchilla de 15 Segmentos
- 15 segment blade
- Lame à 15 segments



- Ergonómico. ABS para mejor agarre
- Ergonomic. ABS for better grip
- Ergonomique. ABS pour une meilleure prise



- Portacuchillas inoxidable
- Stainless blade holder
- Porte-lames inoxydable



Box-Pallet
8320

24 uds

Nº Art.	€
10177	

Ref. **8331**

CUCHILLAS REPUESTO - Spare Blades - Lames de rechange



New!

Mod.	Hoja Blade / Lame mm	€	Nº Art.
18-ERG	18	10	83765

New!

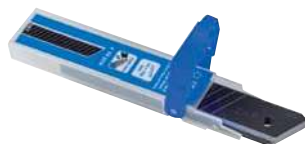

Box-Pallet
8320

20 uds

Nº Art.	€
12676	



Ref. **8318**

CUTER HOJA PARTIBLE 18 MM

18 mm Snap-Off Blade Box Cutter
Couteau à lames rétractables 18 mm

MOD. 18

Zamak
5



Cúter con cuerpo metálico con mecanismo de bloqueo y almacén para cuchillas de repuesto. Incluye 3 cuchillas.

Box Cutter with metal body, locking mechanism and storage for spare blades. Includes 3 blades.

Couteau à lames avec corps en métal, mécanisme de verrouillage et dépôt pour les lames de rechange. Comprend 3 lames.

Mod.	Hoja Blade / Lame mm		Nº Art.	€
18	18	1	34239	



Ref. **8331**

CUCHILLAS REPUESTO - Spare Blades - Lames de rechange

Mod.	Hoja Blade / Lame mm		Nº Art.	€ 1 ud.
18	18	10	34242	

Ref. **8319**

CUTER HOJA SEGURIDAD 19 MM

19 mm Security Blade Box Cutter
Couteau à lame sécurité 19 mm

New! MOD. 19S-RET



- Recogida semiautomática de la cuchilla después del corte, evitando lesiones.
- Mango ergonómico
- Cambio de cuchilla rápido y sencillo. Incluye 3 cuchillas

- After cutting, semi-automatic Blade collection, avoiding injuries.
- Ergonomic handle
- Quick Blade change. Includes 3 blades.

- Ramassage semi-automatique de la lame après la coupe, pour éviter des blessures
- Poignée ergonomique
- Changement de lame rapide et facile. Comprend 3 lames.

Mod.	Hoja Blade / Lame mm		Nº Art.	€
19S-RET	59x19x0,61	1	83360	



Box-Pallet
8320

6 uds

Nº
Art. €
10174



Ref. **8331**

CUCHILLAS REPUESTO

Spare Blades
Lames de rechange

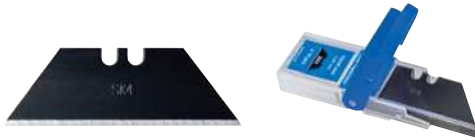

Mod.	Hoja Blade / Lame mm		Nº Art.	€ 1 ud.
19S-RET-TRA	59×19×0,61	10	83766	

New!

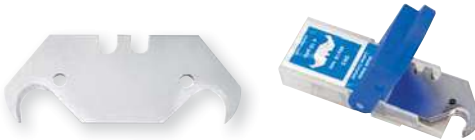

Mod.	Hoja Blade / Lame mm		Nº Art.	€ 1 ud.
19S-RET-GAN	Gancho Hook / Crochet	10	83767	

New!



Box-Pallet
8320

20 uds

Nº Art.	€
12677	



Box-Pallet
8320

20 uds

Nº Art.	€
12682	

Ref. **8319**

CUTER HOJA SEGURIDAD 19 MM

19 mm Security Blade Box Cutter
Couteau à lame sécurité 19 mm

MOD. 19S



Zamak
5



Cúter metálico con almacén para cuchillas de repuesto. Metal Box Cutter with storage for spare blades.

Couteau à lames en métal avec dépôt pour les lames de rechange.

Mod.	Hoja Blade / Lame mm		Nº Art.	€
19S	60×19×0,65	1	34240	



Ref. **8331**

CUCHILLAS REPUESTO - Spare Blades - Lames de rechange

Mod.	Hoja Blade / Lame mm		Nº Art.	€ 1 ud.
19S	60×19×0,65	10	34243	



03.

MADERA

Wood
Bois

BROCAS

Drill Bits
Forets

298

FRESAS

Router Cutters
Fraises

314



BROCAS

Drill Bits

Forets

Ref. **1641**

BROCA PUNTA CENTRAR PRO

PRO Drill Bit
Foret auto-centreur PRO



- Óptima evacuación de viruta
- Más rápida
- Mejor centrado
- Mayor durabilidad
- Mayor precisión
- Agujeros limpios

- Optimum chipping-off
- Faster
- Better centering
- Longer tool life
- Higher precision
- Clean holes

- Evacuation optimale des copeaux
- Plus rapide
- Meilleur auto-centrage
- Vie plus longue de l'outil
- Meilleure precision
- Trous plus propres



Maderas Duras
Hard Wood
Bois dur

Maderas Tropicales
Tropical Wood
Bois Tropical

Contrachapado
Plywood
Contreplaqué

D mm	L mm	l mm	d mm		Nº Art.	€
3	61	33	3	1	34450	
4	75	43	4	1	34451	
5	86	52	5	1	34452	
6	93	57	6	1	34453	
8	117	75	8	1	34454	
10	133	87	10	1	34455	



Línea 33 cm - Ref. 1641



∅	3	4	5	6	8	10
Pcs	5	5	5	5	5	5

Ref. 4995 - Nº Art. 71044: €



Display 55 - Refs. 1651 - 1641



Ref. 1651	∅	22	24	25	26	28	30				
	Pcs	5	5	5	5	5	5	5			
Ref. 1651	∅	10	12	14	16	18	20				
	Pcs	5	5	5	5	5	5	5			
Ref. 1641	∅	3	3	4	4	5	5	6	6	8	10
	Pcs	5	5	5	5	5	5	5	5	5	5

Ref. 4995 - N° Art. 70074: €

Display 58 - Ref. 1641



28
cm

Ref. 1641	∅	3	3	4	4	5	5	6	6	8	10
	Pcs	5	5	5	5	5	5	5	5	5	5

Ref. 4995 - N° Art. 70088: €

Display 52 Mixto PRO - Refs. 1886 - 1641 - 1004



BROCAS MULTI INOX + PARED PRO + MADERA PRO
Multi-Stainless + Concrete Pro + Wood Pro Drill Bits
Forets Multi INOX + béton pro + bois pro

Ref. 1886	∅	3	4	5	6	7	8	9	10	12	14
	Pcs	5	5	10	10	5	5	3	3	3	3
Ref. 1641	∅	3	3	4	4	5	5	6	6	8	10
	Pcs	3	2	3	2	3	2	3	2	5	5
Ref. 1004	∅	1	2	3	3,5	4	4,5	5	6	8	10
	Pcs	2	2	3	3	5	5	5	5	5	3

Ref. 4995 - N° Art. 68575: €



Ref. **1640**

BROCA PUNTA CENTRAR

Center Point Drill Bit
Foret auto-centreur



CrV

Maderas Blandas
Soft Wood
Bois tendre

D mm	L mm	l mm	d mm		Nº Art.	€
3	61	33	3,00	1	18426	
4	75	43	4,00	1	18427	
5	86	52	5,00	1	18429	
6	97	60	6,00	1	18430	
7	109	69	7,00	1	18432	
8	117	75	8,00	1	18433	
9	125	80	9,00	1	18435	
10	133	87	10,00	1	18436	

D mm	L mm	l mm	d mm		Nº Art.	€
11	142	89	9,95	1	30380	
12	151	96	9,95	1	18438	
13	151	96	9,95	1	30381	
14	151	97	9,95	1	18439	
15	160	100	9,95	1	30382	
16	160	100	9,95	1	30383	
18	180	120	9,95	1	17860	
20	200	130	9,95	1	17861	



Larga / Long / Longue

D mm	L mm	l mm	d mm		Nº Art.	€
6	250	200	6,00	1	55969	
8	250	200	8,00	1	55970	
10	250	200	10,00	1	55971	
12	250	200	9,95	1	55972	



Línea 1 m - Ref. 1640



ø	3	4	5	6	7	8	9	10	11	12	13	14	15	16	18	20
Pcs	10	10	10	10	10	10	5	5	5	5	5	5	5	3	3	3

Ref. 4995 - Nº Art. 71047: €



Display 10 - Refs. 1650 - 1640



Ref. 1650 (L 152)	∅	22	24	25	26	28	30	32			
	Pcs	7	5	5	5	5	5	5	5	5	
Ref. 1650 (L 152)	∅	6	8	10	12	14	16	18	20		
	Pcs	7	7	7	7	7	7	7	7	7	
Ref. 1640	∅	3	4	5	6	8	9	10	12	14	16
	Pcs	10	10	10	10	10	5	5	5	5	5

Ref. 4995 - N° Art. 22184: €

Display 51 - Refs. 1880 - 1640 - 1001

BROCAS METAL + PARED + MADERA

Metal + Masonry + Wood Drill Bits

Forets métal + maçonnerie + bois



Ref. 1880	∅	3	4	5	6	7	8	9	10	12	14
	Pcs	10	10	10	10	10	10	5	5	5	5
Ref. 1640	∅	3	4	5	6	8	9	10	12	14	16
	Pcs	10	10	10	10	10	5	5	5	5	5
Ref. 1001	∅	1	2	3	3,5	4	4,5	5	6	8	10
	Pcs	10	10	10	10	10	10	10	5	5	3

Ref. 4995 - N° Art. 68572: €



Display 59 - Refs. 1880 - 1640 - 1002

BROCAS SPEED POINT + PARED + MADERA

Speed Point + Masonry + Wood Drill Bits

Forets speed point + maçonnerie + bois



Ref. 1880	∅	3	4	5	6	7	8	9	10	12	14
	Pcs	10	10	10	10	10	10	5	5	5	5
Ref. 1640	∅	3	4	5	6	8	9	10	12	14	16
	Pcs	10	10	10	10	10	5	5	5	5	5
Ref. 1002	∅	2	3	3,5	4	4,5	5	6	7	8	10
	Pcs	10	10	10	10	10	10	5	5	5	3

Ref. 4995 - N° Art. 70099: €

Display 23 - Refs. 1880 - 1886 - 1640 - 1899

JUEGOS CASSETTE MADERA Y CONSTRUCCIÓN

Wood & Construction Cassette Sets

Jeux cassette bois & construction



Constr. Madera Wood / Bois		Set 1485 - Ref. 1880 Pared Masonry / Béton 5 Pcs.	Set 1486 - Ref. 1886 Pared Pro Masonry Pro / Béton Pro 5 Pcs.	Set 1435 - Ref. 1640 Madera Wood / Bois 5 Pcs.	Set 1438 - Ref. 1640 Madera Wood / Bois 8 Pcs.
	Pcs	5	5	5	5

Constr.		Set 1488 - Ref. 1880 Pared Masonry / Béton 8 Pcs.	Set 1487 - Ref. 1886 Pared Pro Masonry Pro / Béton Pro 8 Pcs.	Set 1494 - Ref. 1890 SDS plus 4 Pcs.
	Pcs	5	5	3

Ref. 4995 - N° Art. 22372: €



Sets - Ref. 1640



Set **1435**

5 Pcs

Cont. Ø	Nº Art.	€
4-5-6-8-10 mm	30223	



Set **1438**

8 Pcs

Cont. Ø	Nº Art.	€
3-4-5-6-7-8-9-10 mm	30226	



Set **1460**

9 Pcs

Cont. Ø	Nº Art.	€
3 Pcs Metal: 5-6-8 3 Pcs Madera/Wood/Bois: 5-6-8 3 Pcs Pared/Masonry/Béton 5-6-8	55610	

Línea 33 cm - 14S1

SETS BROCAS METAL, PARED PRO, PARED, MADERA

Metal, Concrete, Masonry, Wood Sets
 Jeux Métal, Béton, Maçonnerie, Bois



	Metal Metal Métal	Pared Pro Concrete Béton	Pared Masonry Maçonnerie	Madera Wood Bois
Ref	Set 1462 - Ref. 1010	Set 1486 - Ref. 1886	Set 1485 - Ref. 1880	Set 1435 - Ref. 1640
Diam	2-3-4-5-6-8 mm	4-5-6-8-10 mm	4-5-6-8-10 mm	4-5-6-8-10 mm
Pcs.	5	5	5	5
Ref. 4995 - N° Art. 72193:		€		

Ref. **1651**

BROCA PLANA GRAN RENDIMIENTO

Heavy Duty Flat Bit
Mèche plate haut rendement



Maderas Blandas
Soft Wood
Bois tendre



D mm	d mm	L mm	l mm		Nº Art.	€	D mm	d mm	L mm	l mm		Nº Art.	€
6,00	6,35	152	38	1	56019		22,00	6,35	152	42	1	56031	
8,00	6,35	152	38	1	56021		24,00	6,35	152	46	1	56032	
10,00	6,35	152	38	1	56022		25,00	6,35	152	46	1	56033	
12,00	6,35	152	42	1	56023		26,00	6,35	152	46	1	56034	
13,00	6,35	152	42	1	56024		28,00	6,35	152	46	1	56035	
14,00	6,35	152	42	1	56025		30,00	6,35	152	46	1	56036	
16,00	6,35	152	42	1	56026		32,00	6,35	152	46	1	56037	
18,00	6,35	152	42	1	56028		35,00	6,35	152	46	1	56038	
19,00	6,35	152	42	1	56029		38,00	6,35	152	46	1	56040	
20,00	6,35	152	42	1	56030		40,00	6,35	152	46	1	56042	



Set **1651**

8 Pcs

Cont. Ø	Nº Art.	€
12-16-18-20-22-25-28-32 mm	57449	

Línea 1 m - Ref. 1651



Ø	6	8	10	12	14	16	18	20	22	24	25	26	28	30	32	35	38	L305
Pcs	8	8	8	8	8	8	8	8	5	5	5	5	5	5	5	5	5	1

Ref. 4995 - Nº Art. 72169: €

Ref. **1653**

ALARGADOR

Extension
Rallonge



L mm	d mm	D mm		Nº Art.	€
305	6,35	15,85	1	23982	



Display 55 - Refs. 1651 - 1641



Ref. 1651	∅	22	24	25	26	28	30				
	Pcs	5	5	5	5	5	5	5			
Ref. 1651	∅	10	12	14	16	18	20				
	Pcs	5	5	5	5	5	5	5			
Ref. 1641	∅	3	3	4	4	5	5	6	6	8	10
	Pcs	5	5	5	5	5	5	5	5	5	5

Ref. 4995 - N° Art. 70074: €

Display 56 - Ref. 1651



30
cm

∅	10	12	14	16	18	20
	Pcs	10	10	10	10	10

Ref. 4995 - N° Art. 70078: €

Display 57 - Ref. 1651



30
cm

∅	22	24	25	26	28	30
	Pcs	5	5	5	5	5

Ref. 4995 - N° Art. 70084: €

Ref. **1650**

BROCA PLANA

Flat Bit
Mèche plate



Pala
Flat
Plate



Maderas Blandas
Soft Wood
Bois tendre

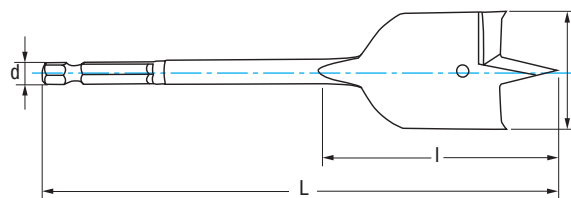

Larga / Long / Longue

D mm	L mm	I mm	d mm		N° Art.	€
6	152	38	6,35	1	30384	
8	152	38	6,35	1	30385	
10	152	38	6,35	1	30386	
12	152	42	6,35	1	30387	
13	152	42	6,35	1	55988	
14	152	42	6,35	1	18457	
16	152	42	6,35	1	18459	
17	152	42	6,35	1	55989	
18	152	42	6,35	1	18460	
19	152	42	6,35	1	55990	
20	152	42	6,35	1	18462	
22	152	42	6,35	1	18463	
24	152	46	6,35	1	18465	
25	152	46	6,35	1	18466	
26	152	46	6,35	1	18468	
28	152	46	6,35	1	18469	
30	152	46	6,35	1	18471	
32	152	46	6,35	1	18472	
35	152	46	6,35	1	55992	
36	152	46	6,35	1	30389	
38	152	46	6,35	1	30390	
40	152	46	6,35	1	17864	

D mm	L mm	I mm	d mm		N° Art.	€
6	400	38	6,35	1	55973	
8	400	38	6,35	1	55974	
10	400	38	6,35	1	55975	
12	400	42	6,35	1	55976	
14	400	42	6,35	1	55977	
16	400	42	6,35	1	55978	
18	400	42	6,35	1	55979	
20	400	42	6,35	1	55980	
22	400	42	6,35	1	55981	
24	400	46	6,35	1	55982	
25	400	46	6,35	1	55983	
28	400	46	6,35	1	55984	
30	400	46	6,35	1	55985	
32	400	46	6,35	1	55986	
35	400	46	6,35	1	55987	



Set **1650**

8 Pcs

Cont. Ø	N° Art.	€
12-16-18-20-22- 25-28-32 mm	66378	



Línea 1 m - Ref. 1650



∅	6	8	10	12	14	16	18	20	22	24	25	26	28	30	32	36	38	L305
Pcs	10	10	10	10	10	10	10	10	5	5	5	5	5	5	5	5	5	1

Ref. 4995 - N° Art. 71051: €

Display 10 - Refs. 1650 - 1640



Ref. 1650 (L 152)	∅	22	24	25	26	28	30	32			
	Pcs	7	5	5	5	5	5	5			
Ref. 1650 (L 152)	∅	6	8	10	12	14	16	18	20		
	Pcs	7	7	7	7	7	7	7	7		
Ref. 1640	∅	3	4	5	6	8	9	10	12	14	16
	Pcs	10	10	10	10	10	5	5	5	5	5

Ref. 4995 - N° Art. 22184: €



Ref. **1655**

BROCA ESPIRAL TORNILLO EN LA PUNTA

Screw-Point Auger Drill Bit

Foret spirale vis en pointe



CrV

Maderas Duras
Hard Wood
Bois dur

	D mm	L mm	I mm	d mm		Nº Art.	€
New!	3	230	155	2,5	1	19792	
New!	4	230	155	3,5	1	19793	
New!	5	230	155	4,5	1	19794	
	6	230	155	5,5	1	19139	
	7	230	155	6,5	1	66809	
	8	230	155	7,5	1	19145	
	9	230	155	8,5	1	66811	
	10	230	155	9,5	1	19148	
	11	230	155	10,5	1	66812	
	12	230	155	11,5	1	19154	
	13	230	155	12,5	1	66813	
	14	230	155	12,5	1	19172	
	16	230	155	12,5	1	19187	
	18	230	155	12,5	1	19202	
	20	230	155	12,5	1	19211	
	22	230	155	12,5	1	19226	
	23	230	155	12,5	1	66814	
	24	230	155	12,5	1	19235	
	25	230	155	12,5	1	66815	
	26	230	155	12,5	1	27304	
	28	230	155	12,5	1	27604	
	30	230	155	12,5	1	27630	
	32	230	155	12,5	1	29040	

	D mm	L mm	I mm	d mm		Nº Art.	€
	6	460	385	5,5	1	60683	
	8	460	385	7,5	1	19082	
	10	460	385	9,5	1	19151	
	12	460	385	11,5	1	19163	
	14	460	385	12,5	1	19181	
	16	460	385	12,5	1	19193	
	18	460	385	12,5	1	19205	
	20	460	385	12,5	1	19217	
	22	460	385	12,5	1	19229	
	24	460	385	12,5	1	19238	
	26	460	385	12,5	1	27603	
	28	460	385	12,5	1	27605	
	30	460	385	12,5	1	27680	
	32	460	385	12,5	1	29041	

	D mm	L mm	I mm	d mm		Nº Art.	€
	8	600	530	7,5	1	67750	
	10	600	530	9,5	1	15811	
	12	600	530	11,5	1	15813	
	14	600	530	12,5	1	15816	
	16	600	530	12,5	1	15817	
	18	600	530	12,5	1	15823	
	20	600	530	12,5	1	15828	
	22	600	530	12,5	1	15855	



New!

Set **1655**

9 Pcs

Cont. Ø	Nº Art.	€
4-5-6-8-10-12-14-16-18-mm	19795	

Línea 1 m - Ref. 1655



ø	6	7	8	9	10	11	12	13	14	16	18	20	22	23	24	25	26	28	30
Pcs	2	2	2	2	2	2	2	2	2	2	2	2	1	1	1	1	1	1	1

Ref. 4995 - Nº Art. 72171: €

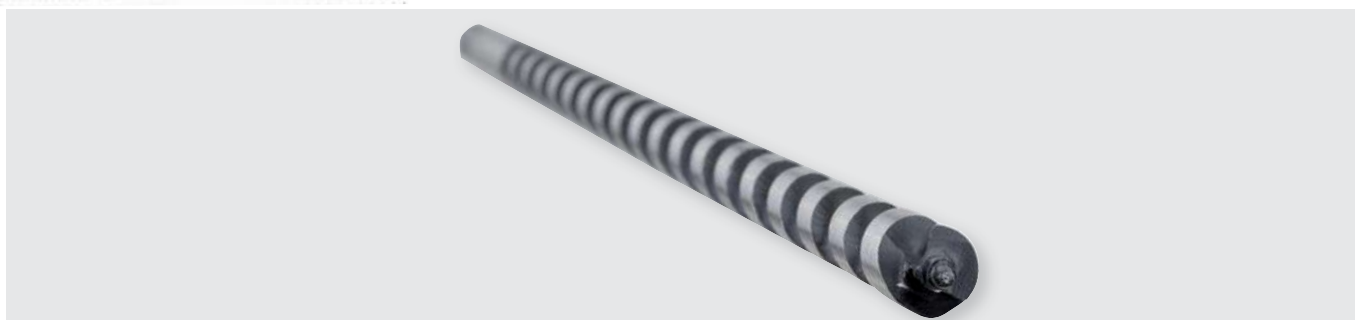



Display 11 - Ref. 1655

∅	18 L460	20 L460	22 L460	24 L460	26 L460	28 L460	30 L460	32 L460
Pcs	2	2	1	1	1	1	1	1
∅	26 L230	28 L230	30 L230	32 L230	10 L460	12 L460	14 L460	16 L460
Pcs	1	1	1	1	2	2	2	2
∅	10 L230	12 L230	14 L230	16 L230	18 L230	20 L230	22 L230	24 L230
Pcs	2	2	2	2	2	2	1	1

Ref. 4995 - N° Art. 22307: €

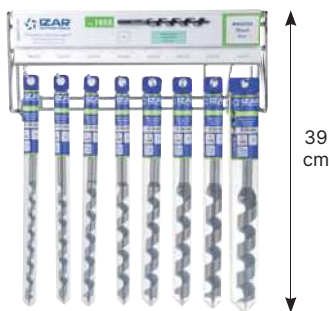

Display 38 - Ref. 1655

∅	10 L230	12 L230	14 L230	16 L230	18 L230	20 L230	22 L230	24 L230
Pcs	2	2	2	2	2	2	1	1

Ref. 4995 - N° Art. 22624: €



Display 39 - Ref. 1655

∅	26 L230	28 L230	30 L230	32 L230	10 L460	12 L460	14 L460	16 L460
Pcs	1	1	1	1	2	2	2	2

Ref. 4995 - N° Art. 22626: €

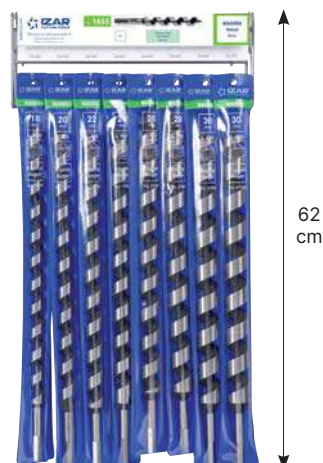

Display 40 - Ref. 1655

∅	18 L460	20 L460	22 L460	24 L460	26 L460	28 L460	30 L460	32 L460
Pcs	2	2	1	1	1	1	1	1

Ref. 4995 - N° Art. 22627: €

Ref. **1644**

BROCA ENCOFRADO MADERA SDS PLUS

SDS PLUS WOOD Cavity Drill Bit
Foret coffrage BOIS SDS PLUS

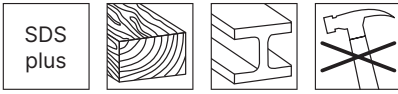

Aceros
Steel
Aciers

Madera
Wood
Bois

D mm	L mm	I mm		Nº Art.	€
10	400	87	1	15447	
12	400	100	1	15450	
14	400	100	1	15453	
16	400	100	1	15460	
18	400	100	1	15507	
20	400	100	1	15576	
22	400	100	1	15579	
24	400	100	1	15582	
26	400	100	1	15603	
28	400	100	1	15621	
30	400	100	1	15627	

D mm	L mm	I mm		Nº Art.	€
10	600	87	1	15660	
12	600	100	1	15669	
14	600	100	1	15780	
16	600	100	1	15781	
18	600	100	1	15783	
20	600	100	1	15784	
22	600	100	1	15793	
24	600	100	1	15799	
26	600	100	1	15801	
28	600	100	1	15807	
30	600	100	1	15808	



Línea 1 m - Ref. 1644 - L400



∅	10 L400	12 L400	14 L400	16 L400	18 L400	20 L400	22 L400	24 L400	26 L400	28 L400	30 L400
Pcs	1	1	1	1	1	1	1	1	1	1	1

Ref. 4995 - Nº Art. 72174: €

Línea 1 m - Ref. 1644 - L600



∅	10 L600	12 L600	14 L600	16 L600	18 L600	20 L600	22 L600	24 L600	26 L600	28 L600	30 L600
Pcs	1	1	1	1	1	1	1	1	1	1	1

Ref. 4995 - Nº Art. 72175: €



Ref. **1643**

BROCA ENCOFRADO MADERA

WOOD Cavity Drill Bit
Foret coffrage BOIS



Aceros
Steel
Aciers

Madera
Wood
Bois

D mm	L mm	l mm	d mm		Nº Art.	€
6	400	57	5	1	23988	
8	400	75	6	1	23989	
10	400	87	8	1	23990	
12	400	100	8	1	23991	
14	400	100	8	1	23992	
16	400	100	10	1	23993	
18	400	100	10	1	23994	
20	400	100	10	1	23995	
22	400	100	10	1	23996	
24	400	100	11	1	23997	
26	400	100	11	1	23999	
28	400	100	11	1	24000	
30	400	100	11	1	24001	

D mm	L mm	l mm	d mm		Nº Art.	€
6	600	57	5	1	24002	
8	600	75	6	1	24004	
10	600	87	8	1	24005	
12	600	100	8	1	24006	
14	600	100	8	1	24007	
16	600	100	10	1	24008	
18	600	100	10	1	24009	
20	600	100	10	1	24010	
22	600	100	10	1	24011	
24	600	100	11	1	24012	
26	600	100	11	1	24013	
28	600	100	11	1	24014	
30	600	100	11	1	24015	



Display 41 - Ref. 1643



Display 42 - Ref. 1643



∅	6	8	10	12	14	16	18	20
	L400	L400	L400	L400	L400	L400	L400	L400
Pcs	2	2	2	2	2	2	2	2

Ref. 4995 - Nº Art. 22629: €

∅	6	8	10	12	14	16	18	20
	L600	L600	L600	L600	L600	L600	L600	L600
Pcs	2	2	2	2	2	2	2	2

Ref. 4995 - Nº Art. 22630: €



Ref. **1692**

BROCA MADERA ESPIRAL SDS PLUS

SDS plus Wood Auger Bit
Foret bois spirale SDS plus

New!



Maderas Duras
Hard Wood
Bois dur

D mm	L mm	I mm		Nº Art.	€
6	230	160	1	79143	
8	230	160	1	79183	
10	230	160	1	79210	
12	230	160	1	79224	
14	230	160	1	79243	
16	230	160	1	79245	
18	230	160	1	79247	
20	230	160	1	79259	

D mm	L mm	I mm		Nº Art.	€
6	460	370	1	79266	
8	460	370	1	79267	
10	460	370	1	79268	
12	460	370	1	79271	
14	460	370	1	79285	
16	460	370	1	79301	
18	460	370	1	79303	
20	460	370	1	79306	
24	460	370	1	84081	
26	460	370	1	84082	



Ref. **1639**

AVELLANADOR MADERA

Shell Drill Bit

Foret outil-lamer-chambrier Bois



HSS



D- mm	D+ mm		Nº Art.	€
3	16	1	56011	
4	16	1	56012	
5	16	1	56013	
6	16	1	56014	
8	20	1	56016	
10	20	1	56018	



Línea 33 cm - Ref. 1639



20
cm

∅	3×16	4×16	5×16	6×16	8×20	10×20
Pcs	2	2	2	2	2	2

Ref. 4995 - Nº Art. 72160:

€



FRESAS

Router Cutters

Fraises

Ref. **1685**

FRESA RANURADO Y COPIADO CON CENTRADOR

Straight Bit with Centre Tip
Fraise rainurage et copiage avec pointe



MD
HM
Carbure

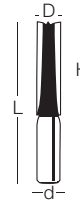
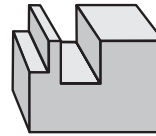

D mm	d mm	L mm	H mm		N° Art.	€
3,00	8,00	37,0	6	1	69222	
4,00	8,00	41,0	10	1	69225	
5,00	8,00	43,0	12	1	69228	
6,00	8,00	48,0	14	1	69231	

D mm	d mm	L mm	H mm		N° Art.	€
8,00	8,00	51,0	20	1	69234	
10,00	8,00	50,0	20	1	69237	
12,00	8,00	50,0	20	1	69240	



Ref. **1669**

FRESA RANURADO Y COPIADO

Straight Bit
Fraise rainurage et copiage



MD
HM
Carbure

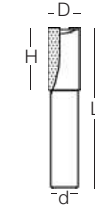
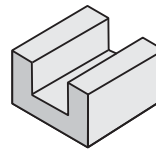

D mm	d mm	L mm	H mm		Z		N° Art.	€
3,00	8,00	47,0	11,0	1	1	36312		
4,00	8,00	47,0	11,0	1	1	36313		
5,00	8,00	47,0	11,0	1	1	36314		
6,00	8,00	48,0	16,0	2	1	36315		
8,00	8,00	51,0	20,0	2	1	36316		
10,00	8,00	51,0	20,0	2	1	36317		
12,00	8,00	51,0	20,0	2	1	36318		

D mm	d mm	L mm	H mm		Z		N° Art.	€
14,00	8,00	51,0	20,0	2	1	36319		
16,00	8,00	51,0	20,0	2	1	36320		
18,00	8,00	51,0	20,0	2	1	36321		
20,00	8,00	51,0	20,0	2	1	36322		
22,00	8,00	59,0	25,0	2	1	36323		
24,00	8,00	43,5	11,5	2	1	36324		



Ref. **1679**

FRESA REBAJADO CON COPIADOR

Rabbeting Bit
Fraise réduction avec copieur



MD
HM
Carbure

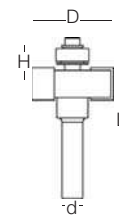
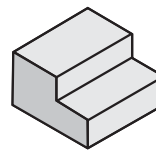

D mm	d mm	L mm	H mm		N° Art.	€
28,50	8,00	54,0	12,7	1	69279	



Ref. **1678**

FRESA REFUNDIDO RECTO CON COPIADOR

Flush Trim Bit
Fraise fusionage droit avec copieur



MD
HM
Carbure

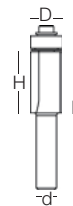
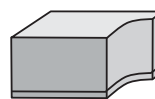
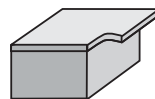

D mm	d mm	L mm	H mm		N° Art.	€
12,70	8,00	70,0	25,4	1	36343	



Ref. **1674**

FRESA RANURAS EN "V"

"V" Grooves Bit
Fraise rainures "V"



MD
HM
Carbure

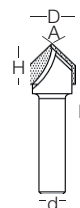
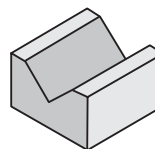

D mm	d mm	L mm	H mm	A		N° Art.	€
12,70	8,00	45,0	12,7	90°	1	60757	
16,00	8,00	46,0	12,7	90°	1	69212	
19,00	8,00	51,0	16,0	90°	1	69214	



Ref. **1676**

FRESA COLA DE MILANO CON PRECORTADOR

Dovetail Bit
Fraise queue d/aronde avec precoupeur



MD
HM
Carbure

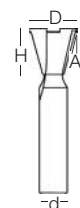
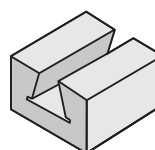

D mm	d mm	L mm	H mm	A		N° Art.	€
12,70	8,00	45,0	12	14°	1	60758	



Ref. **1677**

FRESA BISELADO CON COPIADOR

Bevel Trim Bit
Fraise biseautage avec copieur



MD
HM
Carbure

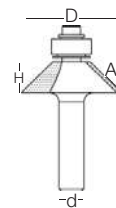
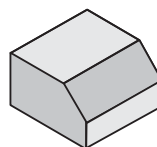

D mm	d mm	L mm	H mm	A		N° Art.	€
31,80	8,00	56,0	15	45°	1	36356	



Ref. **1670**

FRESA RADIO CÓNCAVO

Core Box Bit
Fraise rayon concave



MD
HM
Carbure

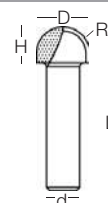
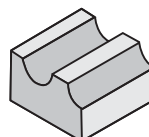

D mm	d mm	L mm	H mm	R		N° Art.	€
9,50	8,00	40,0	9,5	4,8	1	36328	
12,70	8,00	40,0	12,7	6,3	1	36329	



Ref. **1671**

FRESA RADIO CÓNCAVO CON COPIADOR

Cove Bit
Fraise rayon concave avec copieur



MD
HM
Carbure

3 Z

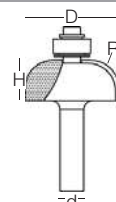
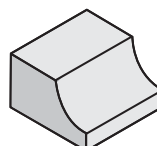

D mm	d mm	L mm	H mm	R		N° Art.	€
28,50	8,00	55,0	14	9,5	1	60759	
35,00	8,00	58,0	16	12,7	1	60760	



Ref. **1672**

FRESA REDONDEADO CANTOS CON COPIADOR

Beading Bit
Fraise arrondir les bouts avec copieur



MD
HM
Carbure

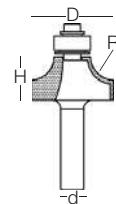
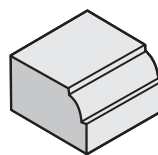

D mm	d mm	L mm	H mm	R		N° Art.	€
25,40	8,00	54,0	13,5	6,3	1	36332	
28,60	8,00	55,0	15,9	7,9	1	36333	
31,80	8,00	56,0	16,7	9,5	1	36334	
38,10	8,00	59,0	19,0	12,7	1	36335	



Ref. **1673**

FRESA REDONDEADO CANTOS CON COPIADOR

Round Over Bit
Fraise arrondir les bouts avec copieur



MD
HM
Carbure

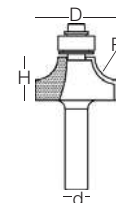
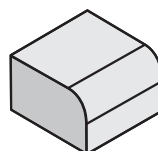

D mm	d mm	L mm	H mm	R		N° Art.	€
25,40	8,00	55,0	13,5	6,3	1	36336	
28,60	8,00	56,0	15,9	7,9	1	36337	
31,80	8,00	57,0	16,7	9,5	1	36338	
38,10	8,00	60,0	19,0	12,7	1	36339	



Ref. **1681**

FRESA PERFILADO CON COPIADOR

Roman Ogee Bit
Fraise profilage avec copieur



MD
HM
Carbure

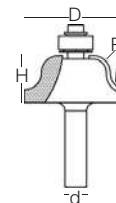
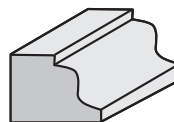

D mm	d mm	L mm	H mm	R		N° Art.	€
35,00	8,00	60,0	17,4	6,30	1	60762	





Ref. **1682**

FRESA PERFILADO
Classical Roman Ogee Bit
Fraise profilage

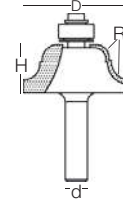
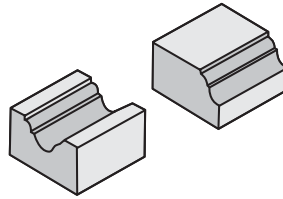

MD
HM
Carbure



D mm	d mm	L mm	H mm	R		N° Art.	€
35,00	8,00	56,0	15,9	4,80	1	60763	





Ref. **1686**

FRESA PERFILADO
Ogee Bit
Fraise profilage

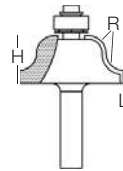
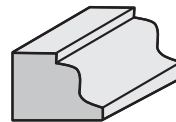

MD
HM
Carbure



D mm	d mm	L mm	H mm	R		N° Art.	€
31,80	8,00	54,0	12,7	4,8	1	69699	
38,00	8,00	57,0	15,9	6,3	1	69701	



Ref. 1685



Ref. 1679



Ref. 1678



Ref. 1674



Ref. 1676



Ref. 1677



Ref. 1670



Ref. 1671



Línea 1 m 16FM

FRESAS MADERA Wood Router Cutters Fraises Bois



Ref.	1669	1669	1669	1669	1669	1669	1669	1670	1670	1674	1674	1676	1677	1678	1679	1686	1681	1682	1685
∅	5	6	8	10	12	14	16	9,5	12,7	12,7	16	12,7	31,80	12,7	28,5	31,8	34,90	35	12
Pcs	1	1	1	1	1	1	1	1	1	1	1	1	1	1	1	1	1	1	1

Ref. 4995 - N° Art. 72181: €

Display 64

FRESAS MADERA Wood Router Cutters Fraises Bois



Ref.	1669	1669	1669	1669	1669	1669
∅	5	6	8	10	12	14
Ref.	1669	1670	1670	1671	1671	1672
∅	16	9,50	12,70	28,50	35	28,60
Ref.	1672	1672	1673	1673	1673	1674
∅	31,80	38,10	28,60	31,80	38,10	12,70
Ref.	1674	1676	1677	1678	1679	1681
∅	16	12,70	31,80	12,70	28,50	34,90
Ref.	1686	1682	1685	1685	1685	1685
∅	31,80	35	6	8	10	12

N° Art. 39710: €

Ref. **1615**

BROCA-FRESA INSTALADORES

TCT Hinge Boring Bit
Mèche à façonner installateurs



Diente MD
Carbide Tipped
Dent Carbure



RPM
Max.
800-1000

Maderas Duras
Hard Wood
Bois dur

Maderas Blandas
Soft Wood
Bois tendre

Indicado carpinteros y ebanistas, para instalación de ventanas, puertas y cocinas en todo tipo de maderas y materiales abrasivos.

Suitable for carpenters and cabinet-makers installing windows, doors & kitchens in all wood types and abrasive materials.

Idéal pour charpentiers et menuisiers pour installation de fenêtres, portes et cuisines tout genre de surfaces et matériaux abrasifs.

D mm	d mm	L mm	l mm		Nº Art.	€
15	8	90	10,00	1	23039	
18	8	90	10,00	1	23040	
20	8	90	12,50	1	23041	
22	8	90	12,50	1	23042	
24	8	90	12,50	1	23043	
25	8	90	12,50	1	23044	
26	8	90	14,50	1	23045	
30	8	90	14,50	1	23046	
35	10	90	14,50	1	23047	
40	10	90	16,50	1	23048	



Línea 33 cm - Ref. 1615



∅	20	25	26	35
Pcs	2	2	2	2

Ref. 4995 - Nº Art. 72183: €



Ref. **1620**

BROCA-FRESA MADERA

WOOD Forstner Bit
Mèche a façonner BOIS

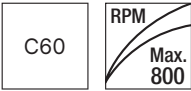

Maderas Duras
Hard Wood
Bois dur

Maderas Blandas
Soft Wood
Bois tendre

Apropiado para todo tipo de maderas naturales, blandas y nobles.

Ideal for use in all natural soft and hard woods.

Idéal pour tout genre de bois naturels, tendres et nobles.

D mm	d mm	L mm	l mm		N° Art.	€
10	9,50	93	8,50	1	18189	
12	9,50	93	9,00	1	18190	
14	9,50	93	9,00	1	18192	
15	9,50	93	9,50	1	18193	
16	9,50	93	9,50	1	18195	
18	9,50	93	10,00	1	18196	
20	9,50	93	10,50	1	18198	
22	9,50	93	11,00	1	18199	
24	9,50	93	11,50	1	18201	
25	9,50	93	11,50	1	18202	

D mm	d mm	L mm	l mm		N° Art.	€
26	9,50	93	11,50	1	18204	
28	9,50	93	12,50	1	18205	
30	9,50	93	13,00	1	18206	
32	9,50	93	13,00	1	18207	
34	9,50	93	13,50	1	18208	
35	9,50	93	13,50	1	18210	
40	9,50	95	15,50	1	18213	
45	9,50	95	16,00	1	18214	
50	9,50	95	17,50	1	18216	



8 Pcs

Cont. Ø	N° Art.	€
15-20-25-30-35-40-45-50 mm	24630	

Línea 33 cm - Ref. 1620



ø	16	20	26	35	40
Pcs	2	2	2	2	2

Ref. 4995 - N° Art. 72185: €



Ref. **1625**

BROCA-FRESA BISAGRAS

Cantilever Hinge Bit
Mèche à façonner charnières



MD
HM
Carbure

D mm	d mm	L mm	l mm		Nº Art.	€
26	8	54	7,50	1	24476	
30	8	54	8,00	1	24477	
35	8	54	8,20	1	24478	



Línea 33 cm - Ref. 1625



∅	26	30	35
Pcs	2	2	2

Ref. 4995 - Nº Art. 72187: €



Ref. **1689**

FRESA ESPUMAS EVA* Y MADERA

EVA Foam & Wood End Mill
Fraise caoutchouc EVA et Bois



**MD
HM**
Carbure

IZAR
Std.

2
Dientes
Teeth/Dents

* **Etilvinilacetato**
Ethylene-vinyl acetate
Éthylène-acétate de vinyle

Espumas EVA
Foam
Caoutchouc

Madera
Wood
Bois

Plásticos
Plastics
Plastiques

D mm	d mm	L mm	l mm	Z		Nº Art.	€
1,00	3	38	3	2	1	79346	
1,50	3	38	7	2	1	79421	
2,00	3	38	17	2	1	79422	
2,50	3	38	17	2	1	79423	
3,00	3	55	32	2	1	79435	
4,00	4	65	42	2	1	79436	
6,00	6	70	42	2	1	79437	
8,00	8	75	42	2	1	79438	
10,00	10	85	42	2	1	79440	



- **Geometría Multi Material válida para una amplia gama de productos como espumas, acrílicos, PVC, ABS, tableros, madera contrachapada, resinas, nylon, etc.**
- **Special Multi Material geometry suitable for a wide range of products such as foams, acrylic, PVC, ABS, hardwood, plywood, resins, nylon, etc.**
- **Géométrie Multi Matériaux pour une gamme large de produits comme mousses, acryliques, PVC, ABC, tableaux, bois contreplaqués, résines, nylon, etc.**
- **Mecanizado de las bandejas de herramientas.**
- **Machining of tool trays.**
- **Usinage de plateaux d'outils.**



Ref. **7009**

BROCA-FRESA ROTOZIP® / ROTOCUT® CERÁMICAS

Ceramic Rotozip® / Rotocut® Cutout Bit
Foret-Fraise Rotozip® / Rotocut® Céramique



Argamasa, Azulejos Cerámica, Estuco,
Mármol, Placas Cemento, Yeso

Concrete Panels, Ceramic Tiles, Marble,
Mortar, Plaster, Stucco

Mortier, Carreaux Faïence Céramique,
Stuc, Marbre, Plaques de ciment, Plâtre

D mm	Pulgadas Inches / Pouces	L	I		Nº Art.	€
3,18	1/8	45,00	21,00	1	18933	
6,35	1/4	50,00	20,50	1	18939	



Ref. **7002**

BROCA-FRESA ROTOZIP® / ROTOCUT® ESCAYOLA

Drywall Rotozip® / Rotocut® Cutout Bit
Foret-Fraise Rotozip® / Rotocut® Plâtre

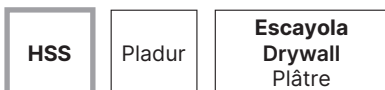

Escayola, Muros Prefabricados

Drywall, Prefabricated Walls

Plâtre, Murs Préfabriqués

D mm	Pulgadas Inches / Pouces	L	I			Nº Art.	€
3,18	1/8	58,00	35,00	3	2	18927	

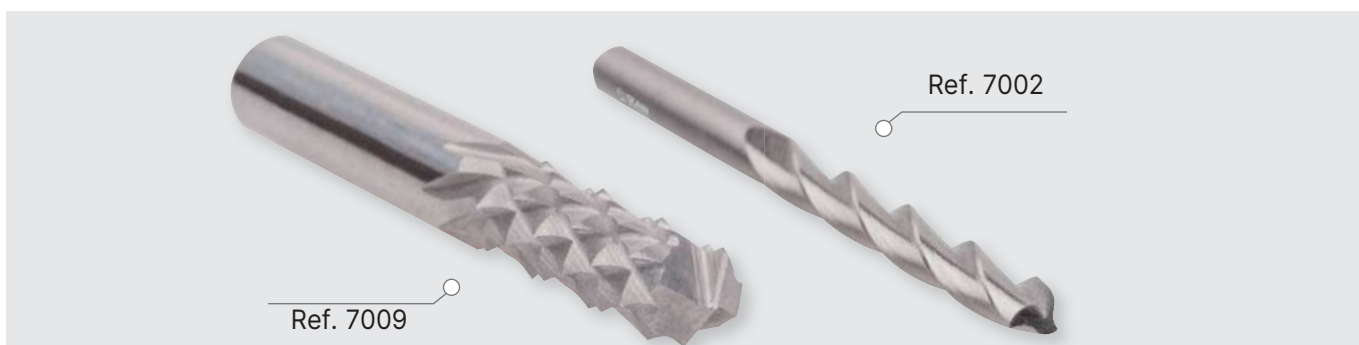

Ref. **7003**

BROCA-FRESA ROTOZIP® / ROTOCUT® AUTO-GUÍA

Autocenter Rotozip® / Rotocut® Cutout Bit
Foret-Fraise Rotozip® / Rotocut® autocentré



HSS

Auto-center

Escayola, Espuma, Muros Prefabricados

Drywall, Foam, Prefabricated Walls

Plâtre, Mousse, Murs Préfabriqués

D mm	Pulgadas Inches / Pouces	L	I	Z	Art.	Nº Art.	€
3,18	1/8	60,00	35,00	1	2	19002	
3,97	5/32	75,00	40,00	1	2	67795	
6,35	1/4	82,00	44,00	1	1	18930	



Ref. **7001**

BROCA-FRESA ROTOZIP® / ROTOCUT® MADERA

Wood Rotozip® / Rotocut® Cutout Bit
Foret-Fraise Rotozip® / Rotocut® Bois



HSS



Aglomerado, Aluminio, Espuma, Fibra Vidrio, Laminados, Plástico, Plexiglas, Vinilo

Aluminium, Chipboard, FibreGlass, Foam, Laminated, Plastics, Plexiglas, Vinyl

Agglomérat, Aluminium, Mousse, Fibre de Verre, Laminés, Plastiques, Plexiglas, Vinyle

D mm	Pulgadas Inches / Pouces	L	I	Z	Art.	Nº Art.	€
3,18	1/8	70,00	35,00	1	2	18999	



Ref. 7003

Ref. 7001



Ref. **1690**

CUCHILLA CEPILLOS ELÉCTRICOS

Planner Blade
Lame à surfacer

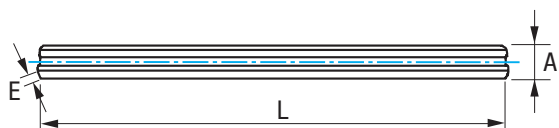

L	A	E		Nº	€
mm	mm	mm		Art.	
82	5,5	1,10	2	60635	*



* € = 1 ud.



04.HEX

ATORNILLADORES DE IMPACTO

Impact Drivers

Visseuses impact

METAL

Metal
Métal

328

CONSTRUCCIÓN

Construction
Construction

340

MADERA

Wood
Bois

345

OTROS

Others
Autres

352



▶ Video

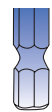

New!

Ref.
1616

BROCA MANGO E6.3 COBALTO

Cobalt E6.3 Shank Drill Bit
Foret queue E6.3 Cobalt



Ref. **1616**

BROCA MANGO E6.3 COBALTO

Cobalt E6.3 Shank Drill Bit
Foret queue E6.3 Cobalt



New!



HSSE 5% Co							Ambar Gold Finish Finition Or	Rectificado Ground Taillé meulé	Materiales Duros Hard Materials Matériaux durs
-------------------	--	--	--	--	--	--	---	---	---

Aceros <1300 N/mm² Steel / Aciers	INOX Ferriticos-Martensíticos Ferritic-Martensitic Stainless INOX Ferritiques-Martensitiques	Titanio Titanium Titane	1 sola pieza solid piece seule pièce
---	---	--------------------------------------	---

- **Fabricada en una sola pieza:** soporta adecuadamente el par de torsión que liberan los atornilladores de impacto más potentes
- **Fabricada con las mismas exigencias de calidad** que el resto de nuestras brocas
- **Produced in 1 solid piece:** It can stand properly the large torque of the impact drivers
- **Manufactured with the same high quality standards** as in the rest of our drill bits
- **Fabriqu  en une seule pi ce :** Il supporte ad quatement le couple de torsion lib r  par les visseuses Impact les plus puissantes
- **Fabriqu  avec la m me exigence** que le reste de nos forets

D mm	L mm	l mm	d mm		N� Art.	�
2,00	68	24	6,35	1	23094	
2,50	68	24	6,35	1	23097	
3,00	68	24	6,35	1	23099	
3,30	70	39	6,35	1	23103	
3,50	70	39	6,35	1	23107	
4,00	75	43	6,35	1	23111	
4,20	75	43	6,35	1	23114	
4,50	80	47	6,35	1	23120	
5,00	86	52	6,35	1	23123	
5,50	93	57	6,35	1	23125	
6,00	93	57	6,35	1	23129	
6,50	101	63	6,35	1	23131	

D mm	L mm	l mm	d mm		N� Art.	�
7,00	109	69	6,35	1	23149	
7,50	109	69	6,35	1	23151	
8,00	117	75	6,35	1	23153	
8,50	117	75	6,35	1	23155	
9,00	125	81	6,35	1	23157	
9,50	125	81	6,35	1	23159	
10,00	133	87	6,35	1	23161	
10,50	133	87	6,35	1	23163	
11,00	142	94	6,35	1	23165	
11,50	142	94	6,35	1	23167	
12,00	151	101	6,35	1	23169	
12,50	151	101	6,35	1	23171	
13,00	151	101	6,35	1	23173	



6 Sets

N� Art.	�
86261	



Set 5 Pcs

Cont. �	N� Art.	�
3-4-5-6-8 mm	35267	



6 Sets

N� Art.	�
86262	



Set 8 Pcs

Cont. �	N� Art.	�
3-4-5-6-7-8-9-10 mm	35268	

Display 74



28 cm

�	2	3	4	4,5	5	6	7	8	9	10
Pcs	5	5	5	5	5	5	3	3	3	3

Ref. 4995 - N  Art. 84044:  



Ref. **1613**

BROCA MANGO E6.3 HSS

HSS E6.3 Shank Drill Bit
Foret queue E6.3 HSS



New!



HSS							Blanca Bright Finish Finition blanche	Rectificado Ground Taillé meulé	Usos General General Purpose Utilisation générale
-----	--	--	--	--	--	--	---	---------------------------------------	---

Aceros <850 N/mm ² Steel / Aciers	Fundición Cast Iron Fonte	Aluminio Aluminium
---	--	------------------------------

1 sola pieza
solid piece
seule pièce

- Fabricada en una sola pieza:** soporta adecuadamente el par de torsión que liberan los atornilladores de impacto más potentes
- Fabricada con las mismas exigencias de calidad** que el resto de nuestras brocas
- Produced in 1 solid piece:** It can stand properly the large torque of the impact drivers
- Manufactured with the same high quality standards as in the rest of our drill bits
- Fabriqué en une seule pièce:** Il supporte adéquatement le couple de torsion libéré par les visseuses Impact les plus puissantes
- Fabriqué avec la même exigence que le reste de nos forets

D mm	L mm	l mm	d mm		Nº Art.	€
2,00	68	24	6,35	1	23093	
2,50	68	24	6,35	1	23096	
3,00	68	24	6,35	1	23098	
3,30	70	39	6,35	1	23100	
3,50	70	39	6,35	1	23106	
4,00	75	43	6,35	1	23109	
4,20	75	43	6,35	1	23113	
4,50	80	47	6,35	1	23115	
5,00	86	52	6,35	1	23121	
5,50	93	57	6,35	1	23124	
6,00	93	57	6,35	1	23127	
6,50	101	63	6,35	1	23130	

D mm	L mm	l mm	d mm		Nº Art.	€
7,00	109	69	6,35	1	23148	
7,50	109	69	6,35	1	23150	
8,00	117	75	6,35	1	23152	
8,50	117	75	6,35	1	23154	
9,00	125	81	6,35	1	23156	
9,50	125	81	6,35	1	23158	
10,00	133	87	6,35	1	23160	
10,50	133	87	6,35	1	23162	
11,00	142	94	6,35	1	23164	
11,50	142	94	6,35	1	23166	
12,00	151	101	6,35	1	23168	
12,50	151	101	6,35	1	23170	
13,00	151	101	6,35	1	23172	



6 Sets

Nº Art.	€
86263	



Set 5 Pcs

Cont. Ø	Nº Art.	€
3-4-5-6-8 mm	35269	



6 Sets

Nº Art.	€
86264	



Set 8 Pcs

Cont. Ø	Nº Art.	€
3-4-5-6-7-8-9-10 mm	35270	

Display 75



Ø	2	3	4	4,5	5	6	7	8	9	10
Pcs	5	5	5	5	5	5	3	3	3	3

Ref. 4995 - Nº Art. 84048: €



Ref. **1611**

BROCA MANGO E6.3 EXTRA CORTA

E6.3 Shank Stub drill Bit
Foret queue E6.3 extra-courte

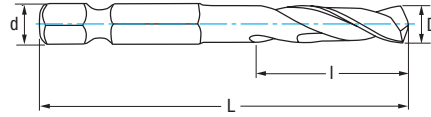

D mm	L mm	l mm	d mm		N° Art.	€
2,00	47	16	6,35	1	56512	
3,00	47	16	6,35	1	15864	
3,20	47	16	6,35	1	56515	
3,25	47	16	6,35	1	15865	
New! 3,30	47	16	6,35	1	85207	
3,50	47	16	6,35	1	15892	
4,00	53	20	6,35	1	15894	
New! 4,10	53	20	6,35	1	85208	
4,20	53	20	6,35	1	56516	

D mm	L mm	l mm	d mm		N° Art.	€
4,25	53	20	6,35	1	15898	
4,50	53	20	6,35	1	15899	
New! 4,90	53	20	6,35	1	85209	
5,00	59	26	6,35	1	15900	
5,50	59	26	6,35	1	15902	
6,00	59	26	6,35	1	15903	
6,50	59	26	6,35	1	15904	
7,00	59	26	6,35	1	15905	
8,00	59	32	6,35	1	15906	



Línea 33 cm - Ref. 1611

20 cm		ø	3	4	5	6	8
		Pcs	5	5	5	5	5
Ref. 4995 - N° Art. 72198:						€	

Ref. **1461**

SET BROCAS MANGO HEXAGONAL 1/4" Y PUNTAS DE ATORNILLAR

Hexagonal Shank Drill Bit and Screwdriver Bit Set
Jeu de forets hexagonales et embouts vissage



Set 17 Pcs

N° Art.	€
82204	

Brocas Metal
Metal Drill Bits
Forets Métal
3- 4 - 5 - 6 mm

d mm: 6,35
 Tx T10
T15
T20
 T25
T30
T40
↳25 mm↳

PH d mm: 6,35
PH1
PH2
PH3
↳25 mm↳

Adapt. Quick-Lock
INOX/Stainless
 U
L mm: 60 - d mm: 6,35

PZ d mm: 6,35
PZ1
PZ2
PZ3
↳25 mm↳

6 Sets

N° Art.	€
19322	



New!

Ref.
1622

BROCA ESCALONADA ESPIRAL MANGO E6.3

E6.3 Shank Spiral Step Drill Bit
Foret étagé spirale queue E6.3



Ref. 1622

BROCA ESCALONADA ESPIRAL MANGO E6.3

E6.3 Shank Spiral Step Drill Bit
Foret étagé spirale queue E6.3



New!

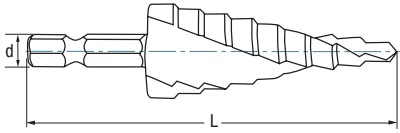

HSSE
5% Co

IZAR
Std.



Chapa
Sheets
Tôle



Aceros
<850 N/mm²
Steel / Aciers

INOX
Stainless Steel
Acier INOX

Cobre
Copper
Cuivre

Aluminio
Aluminium

Termoplásticos
Thermoplastics
Thermoplastiques

- Punta robusta autocentrante
- Avellanado especial 45°
- Menor desgaste y esfuerzo de corte
- Mayor rendimiento y vida útil de la herramienta
- Mejor evacuación de viruta
- Acabado sin rebabas

- Autocentering robust point
- Special 45° Countersinking
- Lower wear and cutting effort
- Better performance & longer tool life
- Better chipping-off
- No-burr finishing

- Pointe plus robuste autocentrante
- Ébavurage special à 45°
- Réduction de l'usure et de l'effort de coupe
- Augmentation de la performance et vie utile de l'outil
- Meilleure évacuation des copeaux
- Finition sans bavures

Cap. mm	Nº Pasos Steps / Étages	L mm	d mm	Nº Art.	€
4-12	9 (4-5-6-7-8-9-10-11-12)	70	6,35	59000	
4-20	9 (4-6-8-10-12-14-16-18-20)	77	6,35	59003	
6-30	13 (6-8-10-12-14-16-18-20-22-24-26-28-30)	98	6,35	59006	



3 Pcs

Cont.	Nº Art.	€
4-12, 4-20, 6-30 mm	86553	

Línea 33 cm - Ref. 1622

21 cm		ø	4-12	4-20	6-30
			Pcs	2	2
			Ref. 4995 - Nº Art. 84051: €		

Display 79 - Refs. 1622 - 1635

22 cm		ø	Ref. 1622				Ref. 1635			
			4-12	4-20	6-30	6-30	12	12	16	19
			Pcs	3	3	3	3	3	3	3
			Ref. 4995 - Nº Art. 85252: €							



Ref. **3610**

MACHO RECTO MÉTRICA MANGO E6.3

E6.3 Shank Metric Straight Tap
Taraud droit métrique queue E6.3

New!

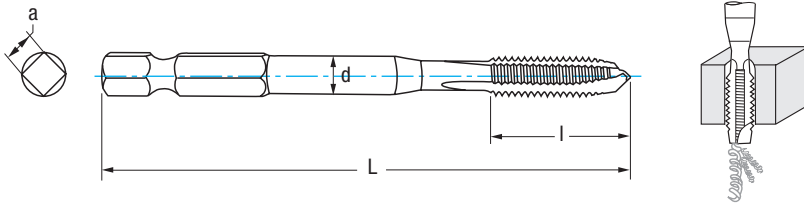

HSSE
5% Co

B
3,5-5h

GUN

Tol.
6H

60°



< 7
mm

Chapa
Sheets
Tôle

1/4" E6.3

Std
+
Imp. Driver

Aceros
<850 N/mm²
Steel / Aciers

Cobre
Copper
Cuivre

Aluminio
Aluminium

M	P	L mm	l mm	d mm	a mm		Nº Art.	€
M3	0,50	56	11	3,50	6,35	1	26706	
M4	0,70	63	13	4,50	6,35	1	26708	
M5	0,80	70	16	6,00	6,35	1	26717	
M6	1,00	80	19	6,00	6,35	1	26718	
M8	1,25	90	22	8,00	6,35	1	26719	
M10	1,50	100	24	10,00	6,35	1	26720	
M12	1,75	110	29	9,00	6,35	1	26721	



Línea 33 cm - Ref. 3610



∅	M3	M5	M6	M8	M10
Pcs	3	3	3	3	3

Ref. 4995 - Nº Art. 84054: €

Display 78 - Refs. 3610 - 3650



∅	Ref. 3610					Ref. 3650				
	M3	M5	M6	M8	M10	M3	M5	M6	M8	M10
Pcs	3	3	3	3	3	3	3	3	3	3

Ref. 4995 - Nº Art. 85251: €



Ref. **3650**

MACHO HELICOIDAL MÉTRICA MANGO E6.3

E6.3 Shank Metric Spiral Tap
Taraud Hélicoïdal métrique queue E6.3

New!

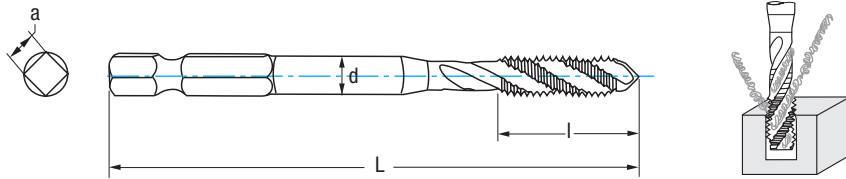

HSSE 5% Co	C 2-3h	GUN	Tol. 6H		60°	 < 7 mm	Chapa Sheets Tôle	 1/4" E6.3	Std + Imp. Driver
----------------------	-----------	-----	------------	--	-----	------------	-----------------------------	---------------	-------------------------

Aceros <850 N/mm ² Steel / Aciers	Cobre Copper Cuivre	Aluminio Aluminium
---	----------------------------------	------------------------------

- Para roscado a mano no se recomiendan profundidades >7 mm, dado que la vibración podría causar roturas de los machos
- When threading by hand, not recommended for depths >7 mm, as the vibration could break the tap
- Pour le taraudage à main, il est déconseillé d'aller au-delà de 7 mm de profondeur, car les vibrations pourraient causer des ruptures des tarauds

M	P	L mm	l mm	d mm	a mm		N° Art.	€
M3	0,50	56	11	3,50	6,35	1	26723	
M4	0,70	63	13	4,50	6,35	1	26725	
M5	0,80	70	16	6,00	6,35	1	26726	
M6	1,00	80	19	6,00	6,35	1	26727	
M8	1,25	90	22	8,00	6,35	1	26728	
M10	1,50	100	24	10,00	6,35	1	26730	
M12	1,75	110	29	9,00	6,35	1	26731	



Línea 33 cm - Ref. 3650



ø	M3	M5	M6	M8	M10
Pcs	3	3	3	3	3

Ref. 4995 - N° Art. 84057: €



Ref. **1614**

BROCA-MACHO-AVELLANADOR MANGO E6.3

E6.3 Shank Combi Tap with Countersink
Outil multi-fonction queue E6.3



New!

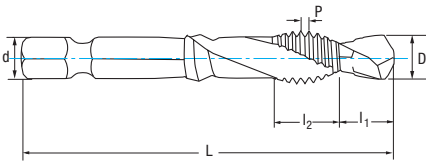

Aceros
<850 N/mm²
Steel / Aciers

Aluminio
Aluminium

D mm	P	L mm	I1 mm	I2 mm	d mm	Avellanado Countersinking Fraisage mm		Nº Art.	€
M3	0,50	52	8,10	8,90	6,35	7,20	1	53437	
M4	0,70	52	8,60	8,90	6,35	7,20	1	53449	
M5	0,80	56	8,90	11,90	6,35	7,20	1	53458	
M6	1,00	56	8,90	11,90	6,35	7,20	1	53463	
M8	1,25	57	8,90	11,90	6,35	9,10	1	53466	
M10	1,50	58	9,60	14,00	6,35	10,80	1	53469	
M12	1,75	69	12,70	14,00	6,35	12,80	1	53472	



6 Sets

Nº Art.	€
84155	



Set 7 Pcs

Cont.	Nº Art.	€
M3-M4- M5-M6- M8-M10- M12	84151	

Línea 33 cm - Ref. 1614

∅	3	4	5	6	8
	Pcs	3	3	3	3

Ref. 4995 - Nº Art. 84060: €



- **3 funciones en 1: Taladrado, Roscado, Avellanado**
- **Roscas limpias y precisas**
- **3 functions in 1: Drilling, threading, Countersinking**
- **Clean and accurate threads**
- **3 fonctions en 1 : Perçage, taraudage, fraisage**
- **Filetages propres et précis**



Ref. **1635**

AVELLANADOR 5Z MANGO E6.3

E6.3 Shank 5Z Countersink
Fraise à noyer 5Z queue E6.3

New!

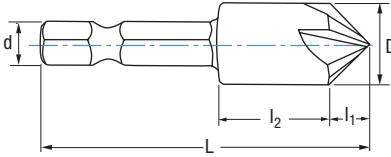

HSSE 5% Co	IZAR Std.	α 90°	5 Z	1/4" E6.3	Std. + Imp. Driver
----------------------	--------------	--------------	-----	-----------	--------------------------

Aceros <850 N/mm ² Steel / Aciers	INOX Stainless Steel Acier INOX	Cobre Copper Cuivre	Aluminio Aluminium	Termoplásticos Thermoplastics Thermoplastiques	Madera Wood Bois
---	--	----------------------------------	------------------------------	---	-------------------------------

- Mecanizado silencioso gracias a los 5 filos de corte
- Poca vibración y acabado excelente
- High number of cutting edges allows a quiet cutting performance
- Chatter-free cutting performance. Excellent surface finishing
- Usinage silencieux grâce aux 5 arêtes de coupe
- Vibration réduite, performance de coupe sans bavardage. Excellente finition de surface

D mm	L mm	l1 mm	l2 mm	d mm	N° Art.	€
12,00	48,50	6,00	16,50	6,35	59009	
16,00	49,50	8,00	15,50	6,35	59012	
19,00	50,00	9,50	14,50	6,35	59015	



Línea 33 cm - Ref. 1635

18 cm		∅	12	16	19
		Pcs	2	2	2
Ref. 4995 - N° Art. 84063:					€

Display 76 - Refs. 3610 - 1635 - 1622 - 1614 - 1616



		Ref. 3610					Ref. 1635				
∅		M3	M5	M6	M8	M10	12	16	19		
Pcs		1	1	1	1	1	1	1	1		
		Ref. 1622			Ref. 1614						
∅		4-12	4-20	6-30	M3	M4	M5	M6	M8		
Pcs		1	1	1	2	2	2	2	2		
		Ref. 1616									
∅		2	3	4	4,50	5	6	7	8	9	10
Pcs		5	5	5	5	5	5	3	3	3	3
Ref. 4995 - N° Art. 85249: €											



Ref. **8352**

REBARBADOR EXTERIOR

External Chamfer Tool
Outil de chanfrein externe

New!

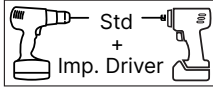
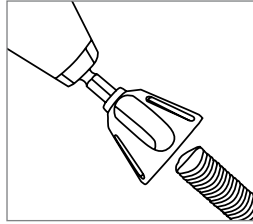

Cuchillas de Metal Duro de alta calidad
High performance Carbide Blades
Lames carbure haute qualité

Aceros
<850 N/mm²
Steel / Aciers

Fundición
Cast Iron
Fonte

Cobre
Copper
Cuivre

Latón
Brass
Laiton

Aluminio
Aluminium

Cap.	Nº Art.	€
Ø 6 - 25 mm	25381	

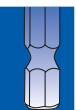

Video



New!

Ref.

1839

BROCA-CORONA DIAMANTE PORCELÁNICO MANGO E6.3

E6.3 Shank Porcelain Diamond Core Bit

Foret-Trépan diamant porcelaine queue E6.3



Ref. **1839**

BROCA-CORONA DIAMANTE PORCELÁNICO MANGO E6.3

E6.3 Shank Porcelain Diamond Core Bit
Foret-Trépan diamant porcelaine queue E6.3

New!

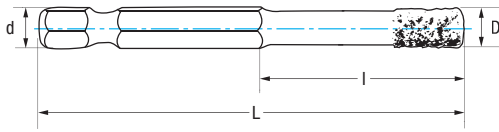

Uso / Use / Usage

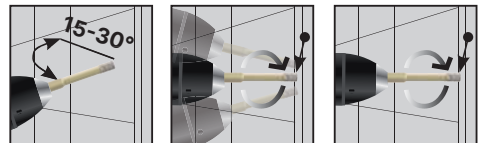

Porcelánico
Porcelain
Porcelaine

Cerámica
Ceramics
Céramique

- Grano de diamante fino adecuado para materiales duros
- Fine grit size of the diamond, suitable for hard materials
- Grain de diamant fin adapté aux matériaux durs
- Incluye un relleno especial de cera que se va disolviendo en el taladrado, ayudando en la refrigeración
- The special wax filled core aids cooling and lubrication
- Inclut un remplissage spécial de cire qui se dissout pendant le perçage, aidant au refroidissement

D mm	L mm	I mm	d mm	Nº Art.	€
5,00	67	10	6,35	31564	
6,00	67	10	6,35	31565	
8,00	80	10	6,35	31566	
10,00	80	10	6,35	31567	
12,00	80	10	6,35	31568	



Línea 33 cm - Ref. 1839

22 cm	Pcs	5	6	8	10	12
		3	3	3	3	3
Ref. 4995 - Nº Art. 84066:						€

Display 77 - Refs. 1834 - 1601 - 1839 - 1834 - 1613



		Ref. 1834			Ref. 1601						
ø		8	10	12	4	5	6	8	10		
Pcs		5	2	2	5	5	3	3	3		
		Ref. 1839					Ref. 1834				
ø		5	6	6	8	10	12	5	6		
Pcs		3	3	3	3	3	3	5	5		
		Ref. 1613									
ø		2	3	4	4,50	5	6	7	8	9	10
Pcs		3	3	3	3	3	3	1	1	1	1
Ref. 4995 - Nº Art. 85250:										€	



New!

Ref.

1834

BROCA VIDRIO Y AZULEJO 4Z+
4Z+ Glass and Soft Tiles Drill Bit
Foret verre et carreau 4Z+



Ref. **1834**

BROCA VIDRIO Y AZULEJO 4Z+

4Z+ Glass and Soft Tiles Drill Bit
Foret verre et carreau 4Z+



New!

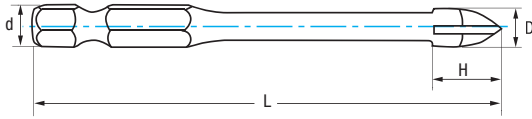

MD/HM TCT					4 Z		
--------------	--	--	--	--	-----	--	--

Vidrio Glass Verre	Cerámica Ceramics Céramique	Porcelánico Blando Soft Porcelain Porcelaine tendre
---------------------------------	--	--

- Punta metal duro con un afilado exclusivo IZAR
- Perforación con precisión debido a la geometría de la punta
- Sus 4 filos de corte permiten una rápida perforación
- Carbide tip with an exclusive IZAR sharpness
- Precision drilling due to the tip's geometry
- Its 4 cutting edges allow for fast drilling
- Pointe en carbure avec un affûtage exclusif IZAR
- Perçage précis grâce à la géométrie de la pointe
- Ses 4 arêtes de coupe permettent un perçage rapide

D mm	d mm	L mm	H mm		Nº Art.	€
5	6,35	75	9,50	1	31873	
6	6,35	75	10,50	1	31992	
8	6,35	85	12,50	1	32075	
10	6,35	85	14,50	1	32099	
12	6,35	90	16,50	1	32117	



6 Sets

Nº Art.	€
69405	



Set 5 Pcs

D mm	Nº Art.	€
5, 6, 8, 10, 12	69403	

Línea 33 cm - Ref. 1834



∅	5	6	8	10	12
Pcs	5	5	5	5	5

Ref. 4995 - Nº Art. 84069: €



Ref. **1601**

BROCA PUNTA METAL DURO PARED

Masonry Carbide Tipped Drill Bit
Foret pointe carbure maçonnerie

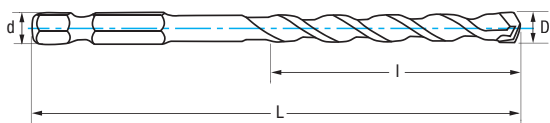

D mm	L mm	l mm	d mm	Art.	Nº	€
4,00	90	45	6,35	1	55997	
5,00	100	50	6,35	1	55998	
6,00	100	50	6,35	1	55999	
8,00	120	60	6,35	1	56000	
10,00	120	60	6,35	1	56001	



¡NUEVO MODELO MEJORADO!
New improved model!
Nouveau modèle amélioré !

Línea 33 cm - Ref. 1601



Ø	4	5	6	8	10
Pcs	5	5	5	5	5

Ref. 4995 - Nº Art. 72200: €



4 Pcs

Cont. Ø	Nº Art.	€
4-5-6-8 mm	59081	

Ref. **1461**

SET BROCAS METAL-PARED-MADERA

Metal-Masonry-Wood Drill Bits Set
Jeu de forets métal-maçonnerie-bois



42 pcs



Brocas rectificadas metal Metal Ground Drill Bits Forets rectifiés métal 2 - 2,5 - 3 - 3,5 - 4 - 5 - 6 mm	Brocas pared Masonry Drill Bits Forets maçonnerie 4 - 5 - 6 - 8 mm	Brocas madera Wood Drill Bits Forets bois 3 - 4 - 5 - 6 - 8 mm
---	--	--

Nº Art. €
79873

Adapt. Quick-Lock INOX / Stainless

L mm: 60 - d mm: 6,35
1 pc.

Cuter Hoja Partible Snap-Off Box Cutter
Couteaux à lames rétractables
1 pc.

Puntas atornillar / Screwdriver Bits / Embouts vissage

PH PH1 PH2 PH3

↳25 mm↳

Tx T10 T15 T20 T25 T27 T30 T40

↳25 mm↳

SL SL 4 SL 5,5 SL 6,5

↳25 mm↳

PZ PZ1 PZ2 PZ3

↳25 mm↳

Ts TS15 TS20 TS25 TS30 TS40

↳25 mm↳

HEX H3 H4 H5

↳25 mm↳



New!



Ref.
1654

BROCA ESPIRAL 3Z TORNILLO EN PUNTA MANGO E6.3

3Z Screw-Point E6.3 Shank Auger Bit

Foret spirale 3Z vis en pointe queue E6.3



Ref. **1654**

BROCA ESPIRAL 3Z TORNILLO EN PUNTA MANGO E6.3

3Z Screw-Point E6.3 Shank Auger Bit
Foret spirale 3Z vis en pointe queue E6.3



New!

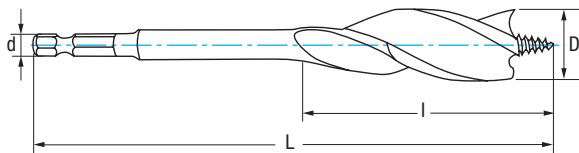

Maderas Duras
Hard Wood
Bois dur

- Gran rendimiento
- Rápido taladrado
- High performance
- Fast drilling
- Haut rendement
- Perçage rapide

D mm	L mm	l mm	d mm		Nº Art.	€
13,00	159	55	6,35	1	58512	
16,00	159	64	6,35	1	58530	
18,00	159	68	6,35	1	58539	
20,00	159	76	6,35	1	58548	
22,00	159	80	6,35	1	58557	
25,00	159	86	6,35	1	58575	
32,00	159	86	6,35	1	58647	



Línea 33 cm - Ref. 1654



∅	16	18	20	22	25
Pcs	5	5	5	5	5

Ref. 4995 - Nº Art. 84072: €



Ref. **1651**

BROCA PLANA GRAN RENDIMIENTO

Heavy Duty Flat Bit

Mèche plate haut rendement

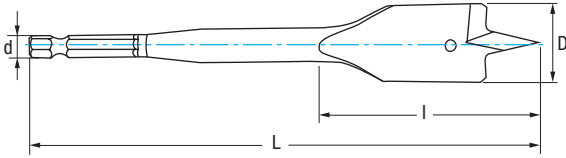

Maderas blandas
Soft Wood
Bois tendre



Set 8 Pcs

Cont.
Ø

Nº
Art.

€

**12-16-18-20-
22-25-28-32
mm**

57449

D mm	L mm	I mm	d mm		Nº Art.	€
6,00	152	38	6,35	1	56019	
8,00	152	38	6,35	1	56021	
10,00	152	38	6,35	1	56022	
12,00	152	42	6,35	1	56023	
13,00	152	42	6,35	1	56024	
14,00	152	42	6,35	1	56025	
16,00	152	42	6,35	1	56026	
18,00	152	42	6,35	1	56028	
19,00	152	42	6,35	1	56029	
20,00	152	42	6,35	1	56030	

D mm	L mm	I mm	d mm		Nº Art.	€
22,00	152	42	6,35	1	56031	
24,00	152	46	6,35	1	56032	
25,00	152	46	6,35	1	56033	
26,00	152	46	6,35	1	56034	
28,00	152	46	6,35	1	56035	
30,00	152	46	6,35	1	56036	
32,00	152	46	6,35	1	56037	
35,00	152	46	6,35	1	56038	
38,00	152	46	6,35	1	56040	
40,00	152	46	6,35	1	56042	

• Agujeros limpios.

• Very clean holes.

• Des trous propres.



Línea 1 m - Ref. 1651



∅	6	8	10	12	14	16	18	20	22	24	25	26	28	30	32	35	38	L305
Pcs	8	8	8	8	8	8	8	8	5	5	5	5	5	5	5	5	5	1

Ref. 4995 - N° Art. 72169: €

Display 56 - Ref. 1651



30
cm

∅	10	12	14	16	18	20
Pcs	10	10	10	10	10	10

Ref. 4995 - N° Art. 70078: €

Display 57 - Ref. 1651



30
cm

∅	22	24	25	26	28	30
Pcs	5	5	5	5	5	5

Ref. 4995 - N° Art. 70084: €

Ref. **1653**

ALARGADOR

Extension
Rallonge



L mm	d mm	D mm		N° Art.	€
305	6,35	15,85	1	23982	



Ref. **1650**

BROCA PLANA

Flat Bit
Mèche plate



**Pala
Flat
Plate**



**Maderas Blandas
Soft Wood
Bois tendre**

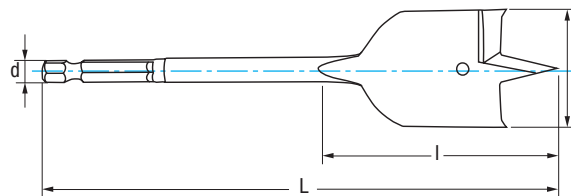

Larga / Long / Longue

D mm	L mm	I mm	d mm		Nº Art.	€
6	152	38	6,35	1	30384	
8	152	38	6,35	1	30385	
10	152	38	6,35	1	30386	
12	152	42	6,35	1	30387	
13	152	42	6,35	1	55988	
14	152	42	6,35	1	18457	
16	152	42	6,35	1	18459	
17	152	42	6,35	1	55989	
18	152	42	6,35	1	18460	
19	152	42	6,35	1	55990	
20	152	42	6,35	1	18462	
22	152	42	6,35	1	18463	
24	152	46	6,35	1	18465	
25	152	46	6,35	1	18466	
26	152	46	6,35	1	18468	
28	152	46	6,35	1	18469	
30	152	46	6,35	1	18471	
32	152	46	6,35	1	18472	
35	152	46	6,35	1	55992	
36	152	46	6,35	1	30389	
38	152	46	6,35	1	30390	
40	152	46	6,35	1	17864	

D mm	L mm	I mm	d mm		Nº Art.	€
6	400	38	6,35	1	55973	
8	400	38	6,35	1	55974	
10	400	38	6,35	1	55975	
12	400	42	6,35	1	55976	
14	400	42	6,35	1	55977	
16	400	42	6,35	1	55978	
18	400	42	6,35	1	55979	
20	400	42	6,35	1	55980	
22	400	42	6,35	1	55981	
24	400	46	6,35	1	55982	
25	400	46	6,35	1	55983	
28	400	46	6,35	1	55984	
30	400	46	6,35	1	55985	
32	400	46	6,35	1	55986	
35	400	46	6,35	1	55987	



Set **1650**

8 Pcs

Cont. Ø	Nº Art.	€
12-16-18-20-22- 25-28-32 mm	66378	

Línea 1 m - Ref. 1650



Ø	6	8	10	12	14	16	18	20	22	24	25	26	28	30	32	36	38	L305
Pcs	10	10	10	10	10	10	10	10	5	5	5	5	5	5	5	5	5	1

Ref. 4995 - Nº Art. 71051: €



Ref. **1621**

BROCA MADERA

Wood Drill Bit
Foret Bois

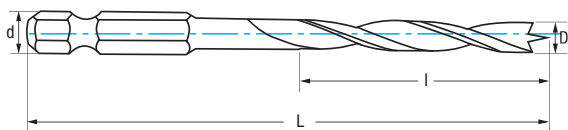

Maderas Blandas
Soft Wood
Bois tendre

D mm	L mm	l mm	d mm		Nº Art.	€
3,00	64	32	6,35	1	56002	
4,00	74	40	6,35	1	56004	
5,00	85	49	6,35	1	56005	
6,00	89	57	6,35	1	56006	
8,00	90	55	6,35	1	56008	



Línea 33 cm - Ref. 1621



∅	3	4	5	6	8
Pcs	5	5	5	5	5

Ref. 4995 - Nº Art. 72201: €

Display 54 - Refs. 1611 - 1610 - 1601 - 1621

BROCAS METAL + PARED + MADERA

Metal + Masonry + Wood Drill Bits
Forets Métal + Maçonnerie + Bois



		Ref. 1611							
∅		2	3	3,25	3,5	4	5	6	8
Pcs		3	3	3	3	3	3	3	3
		Ref. 1610						Ref. 1601	
∅		M3	M4	M5	M6	M8	M10	4	5
Pcs		2	2	2	2	2	2	3	3
		Ref. 1601			Ref. 1621				
∅		6	8	10	3	4	5	6	8
Pcs		3	3	3	3	3	3	3	3

Ref. 4995 - Nº Art. 69804: €



Ref. **1461**

SET BROCAS MANGO HEXAGONAL 1/4" Y PUNTAS DE ATORNILLAR

Hexagonal Shank Drill Bit and Screwdriver Bit Set

Jeu de forets hexagonales et embouts vissage



6 Sets

Nº Art.	€
19291	



Set 17 Pcs

Nº Art.	€
81601	

Brocas Madera
Wood Drill Bits
Forets Bois
3- 4 - 5 - 6 mm

PH d mm: 6,35
PH1
PH2
PH3
L: 25 mm

PZ d mm: 6,35
PZ1
PZ2
PZ3
L: 25 mm

d mm: 6,35
Tx
T10
T15
T20
T25
T30
T40
L: 25 mm

Adapt. Quick-Lock
INOX/Stainless
L mm: 60 - d mm: 6,35





Outils pour les matériaux les plus difficiles

izartool.com/fr

Ref. **1523**

PUNTA ATORNILLAR IMPACTO MANGO E6.3

Impact Screwdriver Bit E6.3 Shank
Embout visage Impact queue E6.3



New!

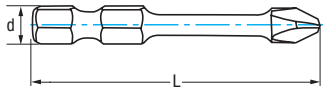

S2 material

60 HRC

d = 6,35 mm

- **Larga vida útil**
- **Soporta grandes pares de torsión**
- **Óptimo acople entre la punta y la cabeza del tornillo**
- **Long life**
- **Suitable for high-torque**
- **Optimal fit between the tip and the screw head**
- **Longue durée de vie**
- **Supporte de grands couples de torsion**
- **Adaptation optimale entre la pointe et la tête de la vis**

PHILLIPS



Tipo Type	L mm	DIN	Torque (Nm)		Nº Art.	€ pack
PH 1	50	E 6.3	5,00	2	58907	
PH 2	50	E 6.3	14,00	2	22807	
PH 3	50	E 6.3	33,60	2	22816	



POZIDRIVE



PZ 1	50	E 6.3	5,00	2	58910	
PZ 2	50	E 6.3	14,00	2	22818	
PZ 3	50	E 6.3	29,40	2	22820	

TORX



TX 20	50	E 6.3	12,70	2	22836	
TX 25	50	E 6.3	19,00	2	22839	
TX 30	50	E 6.3	37,40	2	22843	
TX 40	50	E 6.3	65,10	2	22845	



Ref. **1524**

PUNTA ATORNILLAR EXTRA LARGA

Extra Long Screwdriver Bit
Embout vissage extra-long

New!

Standard
d =
6,35 mm

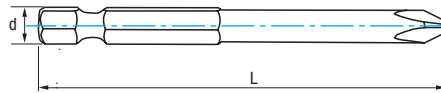

1
Uds



5
Uds

Tipo Type	D mm	L mm	DIN	Nº Art.	€ pack	Nº Art.	€ pack
--------------	---------	---------	-----	------------	-----------	------------	-----------

PHILLIPS



PH	1	75	E 6.3	23222		23225	
PH	2	75	E 6.3	23270		23271	
PH	3	75	E 6.3	23278		23279	
PH	1	100	E 6.3	23227		23229	
PH	2	100	E 6.3	23274		23275	
PH	3	100	E 6.3	23280		23281	
PH	1	150	E 6.3	23230		23231	
PH	2	150	E 6.3	23276		23277	
PH	3	150	E 6.3	23282		23283	

POZIDRIVE



PZ	1	75	E 6.3	23284		23285	
PZ	2	75	E 6.3	23290		23291	
PZ	3	75	E 6.3	23296		23297	
PZ	1	100	E 6.3	23286		23287	
PZ	2	100	E 6.3	23292		23293	
PZ	3	100	E 6.3	23298		23299	
PZ	1	150	E 6.3	23288		23289	
PZ	2	150	E 6.3	23294		23295	
PZ	3	150	E 6.3	23300		23301	

TORX



Tx	10	75	E 6.3	23330		23333	
Tx	15	75	E 6.3	23342		23351	
Tx	20	75	E 6.3	23359		23360	
Tx	25	75	E 6.3	23366		23367	
Tx	27	75	E 6.3	23384		23387	
Tx	30	75	E 6.3	23395		23398	
Tx	40	75	E 6.3	23408		23409	
Tx	10	100	E 6.3	23334		23338	
Tx	15	100	E 6.3	23352		23353	
Tx	20	100	E 6.3	23361		23362	
Tx	25	100	E 6.3	23374		23376	
Tx	27	100	E 6.3	23388		23390	
Tx	30	100	E 6.3	23399		23400	
Tx	40	100	E 6.3	23410		23411	
Tx	10	150	E 6.3	23339		23340	
Tx	15	150	E 6.3	23355		23357	
Tx	20	150	E 6.3	23364		23365	
Tx	25	150	E 6.3	23382		23383	
Tx	27	150	E 6.3	23392		23393	
Tx	30	150	E 6.3	23404		23405	
Tx	40	150	E 6.3	23414		23417	



Ref. **1529**

ADAPTADORES PUNTAS ATORNILLAR

Screwdriver Bit Adaptors
Adaptateurs embouts vissage



Tipo Type	L mm	d mm		Nº Art.	€ pack
Quick Lock INOX / Stainless	60	6,35	1	82687	



Tipo Type	L mm	d mm		Nº Art.	€ pack
Quick Lock	60	6,35	1	33746	



Tipo Type	L mm	d mm		Nº Art.	€ pack
SDS plus	78	6,35	1	33745	



Tipo Type	L mm	d mm		Nº Art.	€ pack
Magnético IND	60	6,35	1	33747	

Adaptador Magnético para Tornillos
Magnetic Screw Adaptor
Adaptateur magnetique pour vis



Tipo Type	mm	L mm	d mm		Nº Art.	€
Adapt.	6	65	6,35	1	42466	
Adapt.	7	65	6,35	1	42472	
Adapt.	8	65	6,35	1	42475	
Adapt.	10	65	6,35	1	42478	
Adapt.	12	65	6,35	1	42481	
Adapt.	13	65	6,35	1	42483	

* Interno / Internal / Intérieur

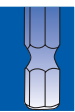

New!

Adaptador de 1/4 a 1/2
1/4 to 1/2 Adaptor
Adaptateur de 1/4 à 1/2

Para uso de herramientas de mango E6.3(1/4)
en llaves de impacto 1/2

It allows the use of E6.3(1/4) shank tools on a 1/2 Impact wrench

Pour utiliser des outils à queue hexagonale E6.3(1/4)
avec clés à choc de 1/2



mm	L mm	d mm		Nº Art.	€ pack
12,7	50	6,35	1	75107	



Set **1529**

Adaptador Magnético para Tornillos
Magnetic Screw Adaptor
Adaptateur magnetique pour vis

5 Pcs

D mm	L mm	d mm		Nº Art.	€
6-7-8- 10-13	65	6,35	5	69751	



Ref. **1527**

TOPE PROFUNDIDAD **PLADUR**

Plasterboard Depth Stop

Butée profondeur Placoplâtre



Tipo Type	D mm	L mm	DIN		Nº Art.	€ pack
PH	2	25	C 6.3	2	77339	
PH	2	50	E 6.3	2	74858	
PZ	2	25	C 6.3	2	81588	
PZ	2	50	E 6.3	2	81589	



Set 4 Pcs

Cont.	Nº Art.	€
PH2 - L25	81594	
PH2 - L50		
PZ2 - L25		
PZ2 - L50		

Ref. **3407**

EXTRACTORES IMPACTO

Impact Extractor
Extracteurs impact

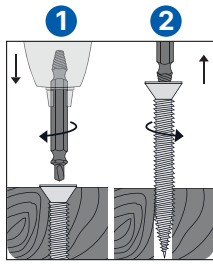

1. Taladrar el tornillo
2. Dar la vuelta y extraer

1. Drill the screw
2. Turn over and remove

1. Percer la vis
2. Retourner et retirez

Mod.	Cap. (mm)	Nº Art.	€
Nº 1	3-5	14953	
Nº 2	4-8	14955	
Nº 3	5-10	14956	
* Nº 4	6-12	14958	

- * Nº4 no es válido para atornillador de impacto
- * Nº4 is not suitable for impact drivers
- * Nº4 n'est pas valide pour les visseuses impact



Set 17 Pcs

Nº Art.	€
72898	



17
pcs

Extractores Impacto
Impact Extractors
Extracteurs impact
N.º 1 - 2 - 3 - 4

PH d mm: 6,35
PH1
PH2
PH3
L mm: 25

PZ d mm: 6,35
PZ1
PZ2
PZ3
L mm: 25

d mm: 6,35
Tx
T10
T15
T20
T25
T30
T40
L mm: 25

Adapt. Quick-Lock
L mm: 60 - d mm: 6,35

Box-Pallet - Ref. 3407



6 Sets

Nº Art.	€
74792	



05.

SIERRAS

Saw Blades
Lames scies

OSCILANTES MULTI-FUNCIÓN

Oscillating Multi-Tools
Outils multifonction

358

SIERRAS SABLE

Sabre Saw Blades
Lames scie sabre

380

SIERRAS CALAR

Jig Saw Blades
Lames scies sauteuses

396



CUADRO USO SIERRAS OSCILANTES MULTI-FUNCIÓN

Oscillating Multi-Tool Table

Tableau utilisation outils multifonction

Ref. Mod. Mat.	STARLOCK																
	MADERA - Wood - Bois							METAL									
	2940	2940	2940	2940	2940	2940	2940	2910	2910	2910	2910	2910	2910	2910	2910	2910	2910
	00010	00020	00030	00040	00050	00060	00070	00010	00020	00030	00040	00050	00060	00070	00080	00090	00100
HCS	HCS	Bime-tal	HCS	HCS	Bime-tal	HCS	MD HM	MD HM	Bime-tal	Bime-tal	Bime-tal	Bime-tal	Bime-tal	Bime-tal	Bime-tal	Bime-tal + TIN	
● Ideal Ideal - Idéal ○ Adecuado Suitable - Convenable																	
Madera Blanda Soft Wood / Bois tendre	●	○	○	●	○	○	●			●	●	●	●	●	●	●	●
Madera Dura Hard Wood / Bois dur		●	●		●	●				●	●	●	●	●	●	●	●
Madera+Clavos Wood+Nails / Bois+Clous								●	●		○		●	●			
Metal								○	○	●	●	●	●	●	●	●	●
INOX / Stainless / Inox								●	●				○				
Plástico / Plastics / Plastique	○			○			○			○	○	○		○	○	○	○
Fibra Vidrio Fibreglass / Fibre verre								○	○								
Abrasivos Abrasive / Abrasifs								○	○								
Pladur / Drywall / Plâtre								○	○	○	○	○					
No ferrosos Non-ferrous / Non ferreux										○	○	○	○				
Perfiles / Profiles / Profils															○	○	○
Parquet-Laminados Laminated-Parquet Parquet-Laminés															○	○	
GFK																	○
Cerámica Ceramics / Céramique																	
Grout-Mortero Grout-Mortar Coulées-Mortier																	
Pulido / Sanding / Poncer																	
Aislamiento Isolating / Isolant																	
Caucho Rubber / Caoutchouc																	
Cuero / Leather / Cuir																	
Restos blandos (pegamento, moqueta, silicona...) Soft remains (glue, carpet, silicone...) Restes tendres (colle, moquette, silicone...)																	



OSCILANTES MULTI-FUNCIÓN

Oscillating Multi-Tools Outils multifonction

LA GAMA MÁS COMPLETA PARA TODOS LOS MATERIALES

The most complete range for every material
La gamme plus complète pour tous les matériaux

Para serrar, cortar, rascar, fresar y escofinar
For sawing, cutting, scraping, milling and rasping
Pour scier, couper, fraiser et gratter

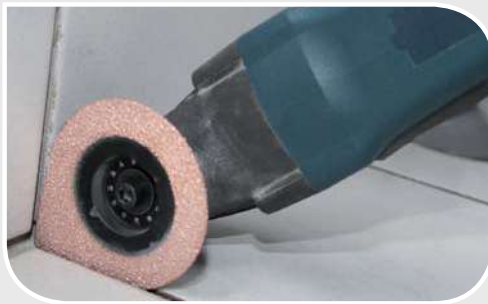

COMPATIBILIDAD / Compatibility / Compatibilité

Starlock:

Bosch GOP 12-28, PMF 220 CE, PMF 250 CES

Starlock Plus:

Bosch GOP 30-28, Bosch GOP 40-30, Bosch GOP 18V-28, Bosch PMF 350 CES, Fein AFMT 12 SL, Fein AFMT 12 QSL, Fein AFMM 18 QSL, Fein FMT 250 SL, Fein FMT 250 QSL, Fein FMM 350 QSL, Fein Multimaster, Fein Multitalent

Starlock Max:

Bosch GOP 55-36, Fein AFSC 18 QSL, Fein AFSC 18 QCSL, Fein FSC 500 QSL

OTROS Others Autres:

Bosch GOP, Bosch PMF, Fein Multimaster, Fein Multitalent, Makita, Hitachi, Metabo, Milwaukee, AEG, Einheil, Ryobi, Skil...

STARLOCK



MADERA
Wood
Bois



METAL



ESPECIAL
Special
Spécial

IZAR
CUTTING TOOLS



STARLOCK

OSCILANTES MULTI-FUNCIÓN

Oscillating Multi-Tools

Outils multifonction

Ref. **2940**

MADERA Wood Bois



Mod **00010**

CORTE CURVO MADERAS BLANDAS

Curve Cutting in Soft Wood
Coupe courbe pour bois tendre

Mod.		Nº Art.	€
00010	1	69095	

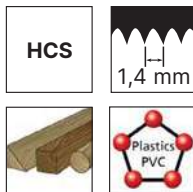
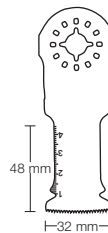

Corte limpio y preciso en maderas blandas y plásticos. Filos de corte redondeados para evitar sacudidas y conseguir una profundización suave del corte. Serrado cerca de bordes, en esquinas y zonas de difícil acceso, como p.e. ventanas estrechas para montar rejillas de ventilación.

Clean and precise cuts in softwood and plastics. Rounded cutting edges for jolt-free and smooth plunge cutting. Sawing near edges and difficult-to-reach areas, such as tight windows to install grilles.

Coupe propre et précise sur bois tendres et plastiques. Filets de coupe arrondis pour éviter les secouées et obtenir une profondeur plus douce de la coupe. Serrage près des bords, en corners et surfaces d'accès difficile, comme fenêtres étroites pour fixer des grilles de ventilation.



Mod **00020**

CORTE CURVO MADERAS DURAS

Curve Cutting in Hard Wood
Coupe courbe pour bois dur

Mod.		Nº Art.	€
00020	1	69096	

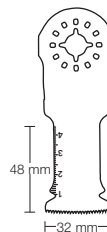

Corte limpio y preciso en maderas, sobre todo duras. Filos de corte redondeados para evitar sacudidas y conseguir una profundización suave del corte.

Clean and precise cuts in Wood, specially in hard wood. Rounded cutting edges for jolt-free and smooth plunge cutting.

Coupe propre et précise sur bois, surtout durs. Filets de coupe arrondis pour éviter les secouées et obtenir une profondeur plus douce de la coupe.





Mod 00030

CORTE CURVO ALTO RENDIMIENTO MADERAS DURAS

High Performance Curve Cutting in Hard Wood
Coupe courbe haut rendement pour bois dur

Mod.		N° Art.	€
00030	1	69097	

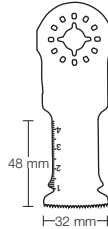

Bimetal	 1,8 mm
	Dentado japonés Japanese Teeth Denture japonais

Corte limpio y preciso en maderas, sobre todo duras. Filos de corte redondeados para evitar sacudidas y conseguir una profundización suave del corte.

Clean and precise cuts in Wood, specially in hard wood. **Rounded cutting edges for jolt-free and smooth plunge cutting.**

Coupe propre et précise sur bois, surtout durs. Filets de coupe arrondis pour éviter les secouées et obtenir une profondeur plus douce de la coupe.



Mod 00040

CORTE CURVO MADERAS BLANDAS

Curve Cutting in Soft Wood
Coupe courbe pour bois tendre

Mod.		N° Art.	€
00040	1	69099	

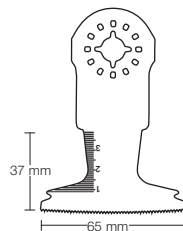

HCS	 1,3 mm
	 Plastics PVC

Corte limpio y preciso en maderas blandas y plásticos. Filos de corte redondeados para evitar sacudidas y conseguir una profundización suave del corte.

Clean and precise cuts in softwood and plastics. **Rounded cutting edges for jolt-free and smooth plunge cutting.**

Coupe propre et précise sur bois, surtout durs. Filets de coupe arrondis pour éviter les secouées et obtenir une profondeur plus douce de la coupe.





Mod **00050**

CORTE CURVO MADERAS DURAS

Curve Cutting in Hard Wood
Coupe courbe pour bois dur

Mod.		N° Art.	€
00050	1	69102	

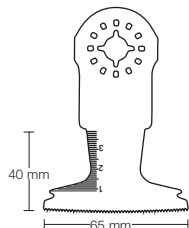

HCS



Dentado japonés
Japanese Teeth
Denture japonais

Corte limpio y preciso en maderas, sobre todo duras. Filos de corte redondeados para evitar sacudidas y conseguir una profundización suave del corte.

Clean and precise cuts in Wood, specially in hard wood. Rounded cutting edges for jolt-free and smooth plunge cutting.

Coupe propre et précise sur bois, surtout durs. Filets de coupe arrondis pour éviter les secouées et obtenir une profondeur plus douce de la coupe.



Mod **00060**

CORTE CURVO ALTO RENDIMIENTO MADERAS DURAS

High Performance Curve Cutting in Hard Wood
Coupe courbe haut rendement pour bois dur

Mod.		N° Art.	€
00060	1	69103	

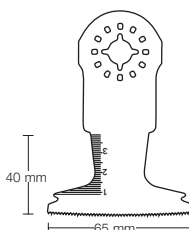

Bimetal



Dentado japonés
Japanese Teeth
Denture japonais

Corte limpio y preciso en maderas, sobre todo duras. Filos de corte redondeados para evitar sacudidas y conseguir una profundización suave del corte.

Clean and precise cuts in Wood, specially in hard wood. Rounded cutting edges for jolt-free and smooth plunge cutting.

Coupe propre et précise sur bois, surtout durs. Filets de coupe arrondis pour éviter les secouées et obtenir une profondeur plus douce de la coupe.







Mod **00070**

HOJA SIERRA SEGMENTADA

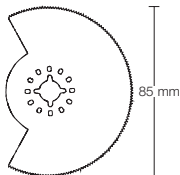
Segmented Saw Blade
Lame segmenté

Mod.		Nº Art.	€
00070	1	69104	



HCS	 1,4 mm
	

Corte limpio y preciso en maderas y plásticos. Tronzado de tubos de plástico, rejillas de ventilación, espigas salientes en uniones de madera. Recorte de molduras o marcos de puerta ya instalados; cortes de inmersión para ajustar tarimas.

Clean and precise cutting of wood and plastic. Parting of plastic pipes, grilles, protrusions in wood-unions. Installed (door) frames cutting; wood flooring plunge cutting.

Coupe propre et précise sur bois et plastiques. Tronçage sur tube en plastiques, grilles de ventilation, chevilles d'union en bois. Coupure des cadres de portes déjà installés, coupes d'immersion pour fixer les parquets.





Mod 00010

ALTO RENDIMIENTO INOX / CLAVOS

Heavy Duty Stainless / Nails
Haut rendement Inox / Clous

Mod.		N° Art.	€
00010	1	69105	

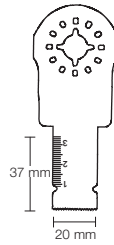

MD HM Carbure	 1,1 mm	
 Inox Stainless		 Fibra Vidrio Fibreglass

Corte limpio y preciso en metal, inoxidable, tornillos, clavos, fibra vidrio, abrasivos, pladur, barras de hierro, tubos negros, grapas.

Clean and precise cuts in metal, stainless Steel, hardened screws, nails, fibreglass, abrasives, drywall, iron bars, black pipes, staples.

Coupe propre et précise sur aciers, Inox, vis, clous, fibre de verre, abrasifs, barreaux de fer, tubes noirs et agrafes.



Mod 00020

ALTO RENDIMIENTO INOX / CLAVOS

Heavy Duty Stainless / Nails
Haut rendement Inox / Clous

Mod.		N° Art.	€
00020	1	69106	

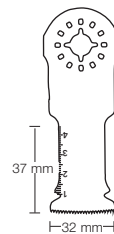

MD HM Carbure	 1,1 mm	
 Inox Stainless		 Fibra Vidrio Fibreglass

Corte limpio y preciso en metal, inoxidable, tornillos, clavos, fibra vidrio, abrasivos, pladur, barras de hierro, tubos negros, grapas.

Clean and precise cuts in metal, stainless Steel, hardened screws, nails, fibreglass, abrasives, drywall, iron bars, black pipes, staples.

Coupe propre et précise sur aciers, Inox, vis, clous, fibre de verre, abrasifs, barreaux de fer, tubes noirs et agrafes.



Mod 00060

CORTE CURVO Y RÁPIDO METAL / MADERA / CLAVOS

Curve & Fast Cutting in Metal / Wood / Nails
Coupe courbe et rapide dans Métal / Bois / Clous

Mod.		Nº Art.	€
00060	1	69111	

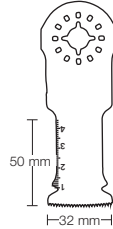

Bimetal	1,3 mm		

Corte limpio y preciso en metal, madera, maderas con clavos, plásticos y materiales no ferrosos. Filos de corte redondeados para evitar sacudidas y conseguir una profundización suave del corte.

Clean and precise cuts in metal, wood, wood with nails, plastics and non-ferrous materials. Rounded cutting edges for jolt-free and smooth plunge cutting.

Coupe propre et précise sur aciers, bois, bois avec clous, plastiques et aciers non ferreux. Filets de coupe arrondis pour éviter des secouées et obtenir une profondeur plus douce de la coupe.



Mod 00030

CORTE RECTO METAL / MADERA

Straight Cut Metal / Wood
Coupe droite Métal / Bois

Mod.		Nº Art.	€
00030	1	69107	

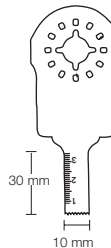

Bimetal	1,3 mm		

Corte limpio y preciso en metal, madera y plásticos, metales no ferrosos, cerraduras, pladur. Aberturas para cajas de enchufe, separación de tubos de cobre a ras de superficie, cortes de inmersión en paneles de cartón enyesado.

Clean and precise cuts in metal, Wood and plastics, non-ferrous metals, locks, drywall. Opening of socket-boxes, separating copper pipes at surface level, plunge cutting in plastered carton-panels.

Coupe propre et précise sur aciers, bois et plastiques, aciers non ferreux, serrures. Ouvertures pour prises, séparation de tubes en cuivres à ras de sol, coupe d'immersion sur panneaux en plâtre.





Mod 00040

CORTE RECTO METAL / MADERA

Straight cutting of Metal / Wood
Coupe droit Métal / Bois

Mod.		N° Art.	€
00040	1	69108	

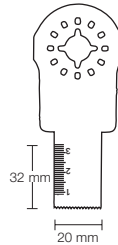

Bimetal	1,3 mm	
		Plastics PVC

Corte limpio y preciso en metal, madera, plásticos y materiales no ferrosos, pladur, clavos, tubos a ras de superficie.

Clean and precise cuts in metal, Wood, plastics and non-ferrous materials, drywall, nails, pipes at the level of the surface.

Coupe propre et précise sur aciers, bois, plastiques et aciers non ferreux, clous, tubes à ras de sol.



Mod 00050

CORTE RECTO METAL / MADERA

Straight cutting of Metal / Wood
Coupe droit Métal / Bois

Mod.		N° Art.	€
00050	1	69109	

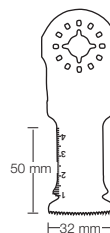

Bimetal	1,3 mm	
		Cu, Ni, Ms, Zn

Corte limpio y preciso en metal, madera, plásticos y materiales no ferrosos, pladur.

Clean and precise cuts in metal, Wood, plastics and non-ferrous materials, drywall.

Coupe propre et précise sur aciers, bois, plastiques et aciers non ferreux, plâtre.



Mod 00070

CORTE CURVO Y RÁPIDO METAL / MADERA / CLAVOS

Curve & Fast Cutting in Metal / Wood / Nails
Coupe courbe et rapide dans Métal / Bois / Clous

Mod.		Nº Art.	€
00070	1	69112	

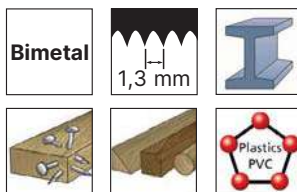
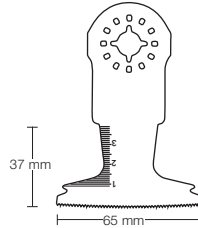

Corte limpio y preciso en metal, madera, maderas con clavos y plásticos. Filos de corte redondeados para evitar sacudidas y conseguir una profundización suave del corte.

Clean and precise cuts in metal, wood, wood with nails and plastics. Rounded cutting edges for jolt-free and smooth plunge cutting.

Coupe propre et précise sur aciers, bois, bois avec clous et plastiques. Filets de coupe arrondis pour éviter des secouées et obtenir une profondeur plus douce de la coupe.



Mod 00080

SIERRA SEGMENTADA. CORTE FINO METAL / MADERA

Segmented Blade. Fine cutting of Metal / Wood
Lame segmenté. Coupe fin dans Métal / Bois

Mod.		Nº Art.	€
00080	1	69113	

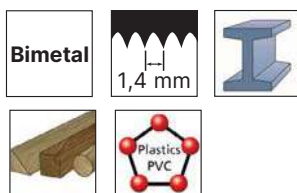
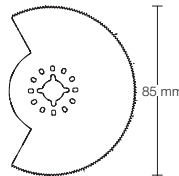

Corte limpio y preciso en metal, madera y plásticos. Recorte de marcos de puertas a ras de suelo, laminados, parquet, listones para perfiles.

Clean and precise cuts in metal, wood, wood with nails and plastics. Door-frame trimming at the level of the floor, laminated, parquet, profile-strips.

Coupe propre et précise sur aciers, bois, bois avec clous et plastiques. Filets de coupe arrondis pour éviter des secouées et obtenir une profondeur plus douce de la coupe.





Mod 00090

SIERRA SEGMENTADA. ALTO RENDIMIENTO METAL / MADERA
 Segmented Blade. High performance in Metal / Wood
 Lame segmenté. haut rendement dans Métal / Bois

Mod.		N° Art.	€
00090	1	69114	

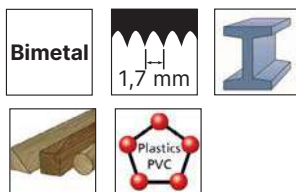
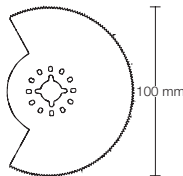

Corte limpio y preciso en metal, madera y plásticos. Recorte de marcos de puertas a ras de suelo, laminados, parqueté, listones para perfiles.

Clean and precise cuts in metal, wood, wood with nails and plastics. Door-frame trimming at the level of the floor, laminated, parquet, profile-strips.

Coupe propre et précise sur aciers, bois et plastiques. Coupures de cadres de portes à ras de sol, laminés, parquets et profils.



Mod 00100

CORTE CURVO MADERAS BLANDAS
 Curve Cutting in Soft Wood
 Coupe courbe pour bois tendre

Mod.		N° Art.	€
00100	1	69115	

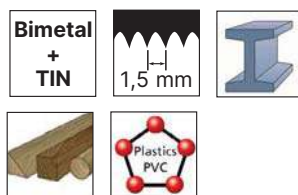
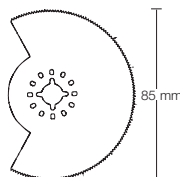

Corte limpio y preciso en metal, madera y plásticos. Dientes recubiertos en titanio para una mayor vida de la herramienta. Corte de entalladuras en epoxy, GFK, listones pequeños para perfiles.

Clean and precise cuts in metal, wood, wood with nails and plastics. Titanium coated teeth for a longer lifetime. Cutting of epoxy-joinings, GFK, small profile-strips.

Coupe propre et précise sur aciers, bois et plastiques. Dents recouvertes en titane pour une plus longue vie de l'outil. Coupure dans les bords, petites barres pour profils.



Mod **00010**

PLACA LIJADORA

Sanding Plate
Patin de ponçage

Mod.		N° Art.	€
00010	1	69116	

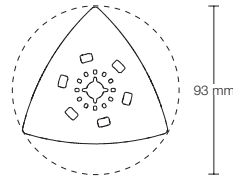

Placa para pulir con fijación tipo micro-velcro.
Sanding plate with micro-velcro type fastening.
Patin de ponçage avec aspiration des poussières.



Mod **00020**

PLACA LIJADORA DESBASTE

Sanding Plate for Roughing
Patin de ponçage ébauche

Mod.		N° Art.	€
00020	1	69117	

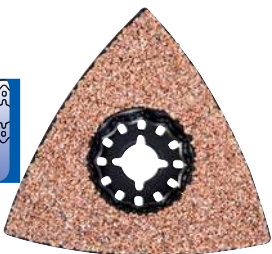
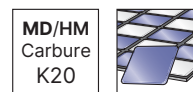
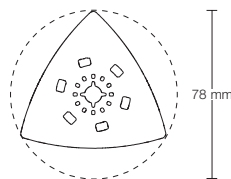

Ideal para eliminar mortero, adhesivo de azulejos y residuos de adhesivos en alfombras, incluso en esquinas gracias a su forma triangular.

Ideal for removing mortar, tile adhesive and carpet adhesive residues even in the corners with the triangle shape.

Conseillé pour supprimer le mortier, colle de carrelage et copeaux collants sur tapis, même aux corners grâce à sa forme triangulaire.



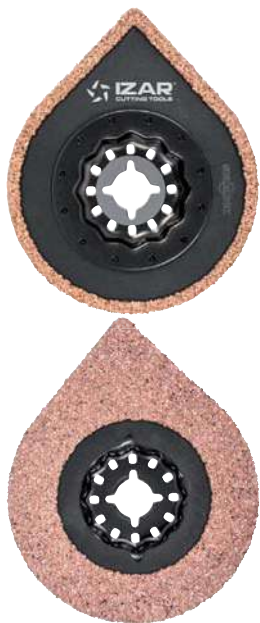

Mod **00030**

SIERRA SEGMENTADA + PLACA LIJADORA
Segmented Saw + Sanding Plate
Lame segmenté à concretion carbure plus patin de ponçage

Mod.		N° Art.	€
00030	1	69118	

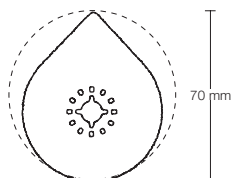

MD/HM	
Carbure K40	
	Medium

Ideal para eliminar grout y mortero de juntas de paredes y suelos, incluso en las esquinas más remotas.

Ideal for removing grout & mortar from Wall and floor tiles, even in the most remote corners.

Conseillé pour supprimer mortier sur joints de murs et sols, même sur les corners plus difficiles.



Mod **00060**

SIERRA INMERSIÓN ABRASIVOS
Plunge Saw for Abrasives
Lame immersion abrasifs

Mod.		N° Art.	€
00060	1	69121	

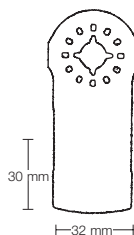

MD/HM		
Carbure K50		Fibra Vidrio Fibreglass
	Medium	

Corte profundo en materiales muy abrasivos como la fibra de vidrio. Filos de corte redondeados para evitar sacudidas y conseguir una profundización suave del corte.

Plunge cutting in strongly abrasive materials, such as fibreglass. Rounded cutting edges for jolt-free and smooth plunge cutting.

Coupe profonde sur matériaux abrasifs comme la fibre de verre. Filets de coupe arrondis pour éviter les secouées et obtenir une profondeur douce de la coupe.





Mod **00040**

SIERRA INMERSIÓN LIJADO FINO

Plunge Saw for Fine Sanding
Râpe à concretion carbure

Mod.		N° Art.	€
00040	1	69119	

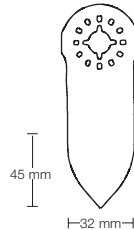

MD/HM
Carbure
K100



Pulido de residuos de pintura, madera, plásticos, composites, epoxy. Ranurado en espacios estrechos y áreas remotas. Usar a 2/3 de la velocidad máxima. Lijado de madera o pintura en zonas de difícil acceso sin papel de lijar.

Sanding of Paint residues, Wood, plastic, composite, epoxy. Slotting in tight gaps and hard-to-reach areas. Use 2/3 of maximum speed. Sanding of wood or painting in difficult-to-reach areas without sanding-paper.

Dégrossissage de residus de peinture, bois, plastiques et composites. Rainurage sur endroits exigus et zones difficiles. Utilisez à 2/3 de la vitesse maximale. Ponçage de peinture ou bois sur zones de difficile accès sans papier de ponçage.



Mod **00050**

SIERRA INMERSIÓN LIJADO DESBASTE

Plunge Saw for Rough Sanding
Râpe à concretion carbure ébauche

Mod.		N° Art.	€
00050	1	69120	

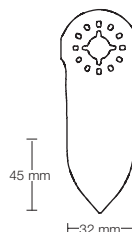

MD/HM
Carbure
K40



Pulido de residuos de pintura, madera, plásticos, composites, epoxy. Ranurado en espacios estrechos y áreas remotas. Usar a 2/3 de la velocidad máxima.

Sanding of Paint residues, Wood, plastic, composite, epoxy. Slotting in tight gaps and hard-to-reach areas. Use 2/3 of maximum speed.

Dégrossissage de residus de peinture, bois, plastiques et composites. Rainurage sur endroits exigus et zones difficiles. Utilisez à 2/3 de la vitesse maximale.





Mod **00070**

CORTE GRUESO ENTRE AZULEJOS

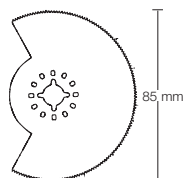

Rough Cutting among Tiles
Coupe grosse carreaux

Mod.		N° Art.	€
00070	1	69122	



Alineado de juntas en azulejos de pared y suelo.
Precise routing joints on wall and floor tiles.
Pour aligner les joints sur carreaux murs et sols.



MD/HM Carbure K30	2 mm 	 Fibra Vidrio Fibreglass
	Grueso Coarse Gross	



Mod **00080**

CORTE FINO ENTRE AZULEJOS

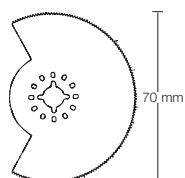

Fine Cutting among Tiles
Coupe fine carreaux

Mod.		N° Art.	€
00080	1	69123	



Alineado de juntas en azulejos de pared y suelo.
Precise routing joints on wall and floor tiles.
Pour aligner les joints sur carreaux murs et sols.



MD/HM Carbure K40	1,4 mm 	 Plastics PVC
	Medium	



Mod **00090**

CORTE DIAMANTE AZULEJOS EXTERIOR

Diamond Cutting of Outer Tiles
Coupe diamant carreaux extérieur

Mod.		N° Art.	€
00090	1	69124	

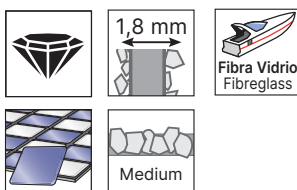
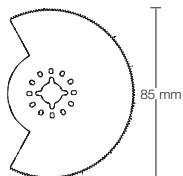

Alineado de juntas en azulejos de pared y suelo. Separación de azulejos, resinas epoxi y plásticos reforzados con fibra de vidrio.

Precise routing joints on wall and floor tiles. Separating of tiles, epoxi gum and fibreglass reinforced plastics.

Pour aligner les joints sur carreaux murs et sols. Séparation de carreaux, résines et plastiques renforcées avec fibre de verre.



Mod **00100**

DENTADO ONDULADO AISLANTES

Waved Teeth for Isolating
Denture vague isolation

Mod.		N° Art.	€
00100	1	69126	

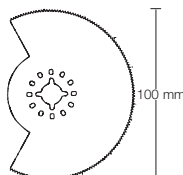

Ideal para materiales de aislamiento como el poliestireno, espuma rígida, materiales blandos como alfombras, caucho, cuero... Cortes a ras de suelo de material sobresaliente.

Ideal for isolating materials, such as polystyrene, rigid foam, soft materials such as carpets, rubber, leather... Cutting of protruding material at floor level...

Conseillé pour matériaux isolation comme le polystyrène, mousse rigide, matériaux tendres comme tapis, cuire... Coupe à ras de sol des matériaux dépassants



Mod 00110

RASCADORA

Scraper
Racloir

Mod.		N° Art.	€
00110	1	69127	

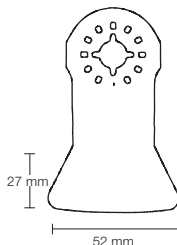

HCS

Restos blandos de pegamento, moqueta, material aglutinante, material de juntas, silicona...
Soft remains of glue, carpet, agglutinative material, joint-material, silicone...
Copeaux tendres de côle, tapis, matière aglutinantes, matériel de jointes, ...



Mod 00120

DENTADO ONDULADO AISLANTES

Waved Teeth for Isolating
Denture vague isolation

Mod.		N° Art.	€
00120	1	69129	

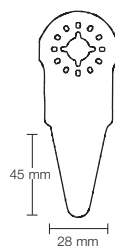

HCS



Jointas de expansión blanda y materiales de aislamiento, silicona en ventanas.
Soft expanding joints and insulating materials, silicone in windows.
Jointes d'expansion tendres et matériaux. silicones en fenêtres.



Mod **00130**

CORTE PRECISO MATERIALES BLANDOS Y ABRASIVOS

Precise Cutting of Soft Materials and Abrasives
Coupe précis de matériaux moelleux et abrasifs

Mod.		Nº Art.	€
00130	1	69130	

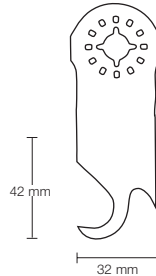

Corte rápido y preciso de material blando y material flexible abrasivo, p.e. alfombras, cartón, PVC...

Fast and precise cutting of soft material and abrasive flexible material, such as carpets, carton, PVC...

Coupe propre et précise sur bois tendres et matériaux flexibles abrasifs. Tapis, cartons, PVC.



SETS

Ref. 2900

SETS MULTI-FUNCIÓN

Oscillating Multi-Tool Sets
Jeux de outils multifonction

Ref. 2940-2910

Ref. 2930

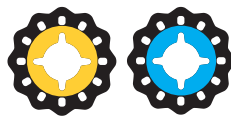

MADERA
Wood Bois
+ METAL

4 Pcs

Cont.	Nº Art.	€
Ref. 2940: Mod. 00030	69702	
Ref. 2910: Mods. 00020-00060-00070		



ESPECIAL
Special
Spécial

4 Pcs

Cont.	Nº Art.	€
Ref. 2930: Mods. 00020-00060-00070-00080	69704	





Línea 1 m 2900 - Refs. 2910 - 2930 - 2940

25 cm		Ref.	2910	2910	2910	2910	2930	2930	2940	2940	2940
			00030	00050	00070	00080	00080	00110	00020	00030	00070
		Pcs	3	3	3	3	3	3	3	3	3
Ref. 4995 - N° Art. 72189: €											

Display 53 - Refs. 2940 - 2910 - 2930



Ref. 2940			
∅	Mod. 00020	Mod. 00030	Mod. 00070
Pcs	3	3	3
Ref. 2910			
∅	Mod. 00030	Mod. 00050	Mod. 00070
Pcs	3	3	3
Ref. 2910		Ref. 2930	
∅	Mod. 00080	Mod. 00080	Mod. 00110
Pcs	3	3	3
Ref. 4995 - N° Art. 69451: €			



Mod 00010

CORTE RECTO MADERAS BLANDAS

Soft Wood Straight Cutting
Coupe droite bois tendre

Mod.		Nº Art.	€ Pack
00010	5	69140	

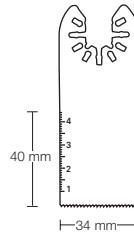

Dentado estándar. Corte en madera y plástico.

Standard teeth for wood and plastics.

Denture estándar. Coupe en bois et plastique.



Mod 00020

CORTE RECTO MADERAS DURAS

Hard Wood Straight Cutting
Coupe droite bois dur

Mod.		Nº Art.	€ Pack
00020	5	69141	

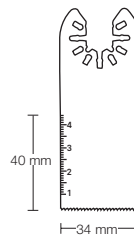

Dentado ondulado universal. Corte en madera, plástico, pladur, metal y madera con clavos.

Universal wave teeth for wood, plastics, drywall, metal and wood with nails.

Denture vague universelle. Coupe en bois, plastique, plâtre, métal et bois avec clous.



Mod 00030

CORTE RECTO ALTO RENDIMIENTO MADERAS DURAS

Hard Wood High Performance Straight Cutting
Coupe droite haut rendement bois dur

Mod.		Nº Art.	€ Pack
00030	5	69142	

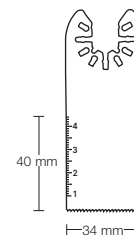

Dentado japonés para corte en madera, contrachapado, plástico y otros materiales blandos.

Japanese teeth for wood, plywood, plastics and other soft materials.

Denture japonaise pour coupe en bois, tole fine metal, plastiques et autres bois tendres.



Ref. 2950

MULTI



QUICK-FIT



Mod 00040

RASCADORA
Scraper
Racloir

Mod.		N° Art.	€ Pack
00040	5	69457	

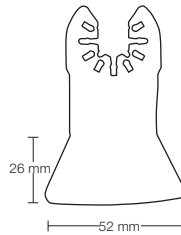

Rascador de silicona o similares en superficies lisas y delicadas como azulejos o cristal.

Removing of silicone or caulking against a flat surface such as tile or glass that can be easily scratched.

Racloir silicone ou similaire pour surfaces lises et delicats comme carreaux ou verre.



Ref. 2960

MULTI



SUPERCUT



Mod 00010

CORTE RECTO METAL / MADERA / CLAVOS
Straight Cutting in Metal / Wood / Nails
Coupe droite dans Métal / Bois / Clous

Mod.		N° Art.	€ Pack
00010	5	69143	

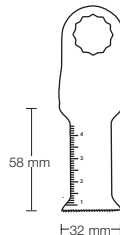

Dentado ondulado universal para madera, pladur, plástico, metal y madera con clavos. Mango acero inoxidable.

Universal wave teeth for wood, drywall, plastics, metal and wood with nails. Stainless steel holder.

Denture vague universelle pour bois, plâtre, plastique, métal et bois avec clous. Queue en acier inoxydable.



Mod 00020

CORTE RECTO METAL / MADERA / CLAVOS
Straight Cutting in Metal / Wood / Nails
Coupe droite dans Métal / Bois / Clous

Mod.		N° Art.	€ Pack
00020	5	69144	

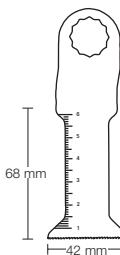

Dentado ondulado universal para madera, pladur, plástico, metal y madera con clavos. Mango acero inoxidable.

Universal wave teeth for wood, drywall, plastics, metal and wood with nails. Stainless steel holder.

Denture vague universelle pour bois, plâtre, plastique, métal et bois avec clous. Queue en acier inoxydable.



CUADRO USO SIERRAS SABLE

Sabre Blade Use Table
Tableau utilisation lames scies sabre

							MADERA Wood - Bois				PLÁSTICOS Plastics - Plastiques			ME- TAL		
							Todos tipos All types Toutes sortes	Dura Hard Dur	Pallet Palet Palette	Marcos ventana Window frames Fenêtres	Con clavos With nails Avec clous	Viva Green Vert	Plásticos Plastics Plastiques	Reforzados fibra-carbón Carbon-fibre reinforced Renforcés fibre-carbone	Plexiglass	INOX Stainless
							● Ideal ● Ideal - Idéal									
							○ Adecuado ○ Suitable - Convenable									
Ref. - Mod.	Equiv.	Mat.	TPI	I mm	Pág.											
Madera Wood - Bois	1950 00010	S1617K	HCS/CV	3	280	382	●	○				●				
		00020	S644D	HCS/CV	6	130	382	●	○				●			
		00030	S1531L	HCS/CV	4-5	220	383					●				
		00210	S2345X	HCS/CV	6	220	383	●	○				●		●	
		00220	S611VF	Bi-metal	5-8	130	384	●	○		●					
		00230	S1111VF	Bi-metal	5-8	205	384	●	○		●					
Metal Metal - Métal	1920 00020	S922EF	Bi-metal	18	130	385									●	
		00030	S922BF	Bi-metal	14	130	386								●	
		00050	S1025VF	Bi-metal	10-14	180	387			●		●				
		00200	S1122EF	Bi-metal	18	180	385								●	
		00210	S1122BF	Bi-metal	14	180	386								●	
		00220	S922HF	Bi-metal	10	130	387								●	
		00230	S1122HF	Bi-metal	10	180	388								●	
		00240	S1211HF	Bi-metal	10	260	388								●	
		00250		Bi-metal	10-14	130	389				●					
		00260	S123XF	Bi-metal	10-14	205	389				●					
	00280		Bi-metal	10	280	389				●				●		
Especial Special	1960 00020	S922VF	Bi-metal	10-14	130	390	●	○	●		●					
		00030	S1122VF	Bi-metal	10-14	205	390	●	○	●		●				
		00040	S611DF	Bi-metal	6	130	391	●	○				●			
		00060	S1411DF	Bi-metal	6	280	391	●	○				●			
		00200	S1141HM	CV-HM	3	205	392	○	●					●		
		00210	S1241HM	CV-HM	3	280	392	○	●					●		
		00220	S1211K	INOX	4	280	394	●	○							
		00240	S1213AWP	HCS/CV		280	394									
		00260	S1243HM	CV-HM	2	305	393									
		00270	S2243HM	CV-HM	2	455	393									



SIERRAS SABLE

Sabre Saw Blades

Lames scie sabre

Ref. **1950**

MADERA Wood Bois

Mod **00010**

CORTE BASTO

Rough Cut
Coupe grosse



S1617K



Dentado alterno y afilado diagonal. Corte basto para madera en general y madera viva.

Side set and diagonally sharpened toothing. Rough cutting of wood and green wood.

Denture avoyée, dépouillée et affûtée. Coupe grosse dans différents types de bois et bois verts.

Mod.	TPI	Diente Tooth Dent mm	L mm	I mm		Nº Art.	€ pack
00010	3	8,5	300	280	5	18870	



Mod **00020**

CORTE RÁPIDO RECTO

Straight Fast Cut
Coupe rapide droite



S644D



Dentado alterno y afilado diagonal. Corte rápido y recto en todo tipo de maderas, plásticos y pladur.

Side set and diagonally sharpened toothing. Fast and straight cutting for all wood types, plastics and drywall.

Denture avoyée, dépouillée et affûtée. Coupe rapide et droite dans différents types de bois, plastiques et plâtres.

Mod.	TPI	Diente Tooth Dent mm	L mm	I mm		Nº Art.	€ pack
00020	6	4,2	150	130	5	18871	



Mod **00030**

MADERA VIVA

Green Wood
Bois verts



S1531L



Dentado alterno reforzado por inducción con afilado diagonal. Especial madera viva.

Side set and diagonally sharpened induction hardened toothing. Special for green wood.

Denture avoyée, dépouillée, affûtée et traitée inductivement. Spécial pour bois verts.

Mod.	TPI	Diente Tooth Dent mm	L mm	I mm		Nº Art.	€ pack
00030	4-5	6,35-5	300	280	5	18872	



Mod **00210**

CORTE LIMPIO

Clean Cut
Coupe propre



S2345X

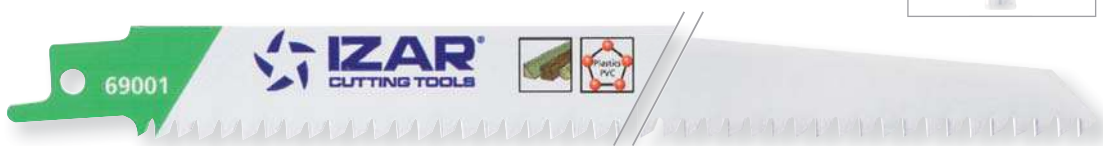

Dentado afilado triple. Corte limpio en todo tipo de maderas y plásticos.

Triply sharpened toothing. Clean cutting of all types of wood and plastics.

Denture triple dépouillée et affûtée. Coupe propre dans différents types de bois et plastiques.

Mod.	TPI	Diente Tooth Dent mm	L mm	I mm		Nº Art.	€ pack
00210	6	4,2	240	220	5	69001	



Mod 00220

CORTE RECTO ANCHO ESPECIAL

Special Thick Straight Cut
Coupe droite très grosse



S611VF



Dentado alterno y variable. Ancho de sierra especial para corte recto en todo tipo de maderas con residuos de metales.

Side set and variable tothing. Special thick blade for straight cutting of all wood types with few metal residues.

Denture fraisée, affûtée et variable. Lame très grosse pour coupe droite dans différents types de bois.

Mod.	TPI	Diente Tooth Dent mm	L mm	I mm		Nº Art.	€ pack
00220	5,8	5-3,2	150	130	5	69002	



Mod 00230

CORTE RECTO LARGO ANCHO ESPECIAL

Special Thick Long Straight Cut
Coupe droite longue très grosse



S1111VF



Dentado alterno y variable. Ancho de sierra especial para corte recto en todo tipo de maderas con residuos de metales.

Side set and variable tothing. Special thick blade for straight cutting of all wood types with few metal residues.

Denture fraisée, affûtée et variable. Lame très grosse pour coupe droite dans différents types de bois.

Mod.	TPI	Diente Tooth Dent mm	L mm	I mm		Nº Art.	€ pack
00230	5-8	5-3,2	225	205	5	69003	



Mod 00020

UNIVERSAL CORTE FLEXIBLE

Universal Flexible Cut
Universel coupe flexible



S922EF

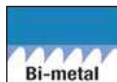

TPI
18



Dentado fresado y ondulado. Sierra flexible y universal para aceros e inoxidables.

Milled teeth and wavy set. Flexible and universal blade for steel and stainless steel.

Dents fraisés et ondulés. Lame flexible et universel pour aciers et Inox.

Mod.	TPI	Diente Tooth Dent mm	L mm	I mm		Nº Art.	€ pack
00020	18	1,4	150	130	5	18865	



Mod 00200

UNIVERSAL CORTE FLEXIBLE LARGO

Universal Long Flexible Cut
Universel coupe flexible longue



S1122EF



TPI
18



Dentado fresado y ondulado. Sierra flexible y universal para aceros e inoxidables.

Milled teeth and wavy set. Flexible and universal blade for steel and stainless steel.

Dents fraisés et ondulés. Lame flexible et universelle pour aciers et Inox.

Mod.	TPI	Diente Tooth Dent mm	L mm	I mm		Nº Art.	€ pack
00200	18	1,4	200	180	5	69004	



Mod 00030

CORTE ACEROS, INOX, NO FERROSOS

Steel, Stainless, Non-Ferrous Cut
Coupe Aciers, Inox, Non ferreux



S922BF



Dentado fresado y ondulado. Sierra flexible y universal para aceros, inoxidable y metales no ferrosos.

Milled teeth and wavy set. Flexible and universal blade for steel, stainless steel and non-ferrous metals.

Dents fraisés et ondulés. Lame flexible et universelle pour aciers, Inox et métaux non ferreux.

Mod.	TPI	Diente Tooth Dent mm	L mm	I mm		Nº Art.	€ pack
00030	14	1,8	150	130	5	18866	



Mod 00210

CORTE LARGO ACEROS, INOX, NO FERROSOS

Steel, Stainless, Non-Ferrous Long Cut
Coupe longue Aciers, Inox, Non ferreux



S1122BF



Dentado fresado y ondulado. Sierra flexible y universal para aceros, inoxidable y metales no ferrosos.

Milled teeth and wavy set. Flexible and universal blade for steel, stainless steel and non-ferrous metals.

Dents fraisés et ondulés. Lame flexible et universelle pour aciers, Inox et métaux non ferreux.

Mod.	TPI	Diente Tooth Dent mm	L mm	I mm		Nº Art.	€ pack
00210	14	1,8	200	180	5	69005	



Mod 00050

CORTE RECTO ANCHO ESPECIAL PALLETS

Pallet Special Thick Straight Cut
Coupe droite très grosse palettes



S1025VF



Dentado fresado, ondulado y variable. Ancho de sierra especial para corte recto en todo tipo de maderas con residuos de metales. Especial reparación de pallets.

Side set, wavy and variable toothing. Special thick blade for straight cutting of all wood types with few metal residues. Special for pallet repair.

Denture ondulé et variable. Lame très grosse pour coupe droite dans différents types de bois. Spécial pour réparation de palettes.

Mod.	TPI	Diente Tooth Dent mm	L mm	I mm		Nº Art.	€ pack
00050	10-14	2,5-1,8	200	180	5	18868	



Mod 00220

CORTE ACEROS, INOX, NO FERROSOS

Steel, Stainless, Non-Ferrous Cut
Coupe Aciers, Inox, Non ferreux



S922HF



Dentado fresado y ondulado. Sierra flexible y universal para aceros, inoxidable y metales no ferrosos.

Milled teeth and wavy set. Flexible and universal blade for steel, stainless steel and non-ferrous metals.

Dents fraisés et ondulés. Lame flexible et universelle pour aciers, Inox et métaux non ferreux.

Mod.	TPI	Diente Tooth Dent mm	L mm	I mm		Nº Art.	€ pack
00220	10	2,5	150	130	5	69006	



Mod 00230

CORTE LARGO ACEROS, INOX, NO FERROSOS

Steel, Stainless, Non-Ferrous Long Cut
Coupe longue Aciers, Inox, Non ferreux



S1122HF

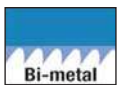

Dentado fresado y ondulado. Sierra flexible y universal para aceros, inoxidable y metales no ferrosos.

Milled teeth and wavy set. Flexible and universal blade for steel, stainless steel and non-ferrous metals.

Dents fraisés et ondulés. Lame flexible et universelle pour aciers, Inox et métaux non ferreux.

Mod.	TPI	Diente Tooth Dent mm	L mm	I mm	📦	Nº Art.	€ pack
00230	10	2,5	200	180	5	69007	



Mod 00240

CORTE ACEROS, INOX, NO FERROSOS

Steel, Stainless, Non-Ferrous Cut
Coupe Aciers, Inox, Non ferreux



S1211HF



Dentado fresado y ondulado. Sierra flexible y universal para aceros, inoxidable y metales no ferrosos.

Milled teeth and wavy set. Flexible and universal blade for steel, stainless steel and non-ferrous metals.

Dents fraisés et ondulés. Lame flexible et universelle pour aciers, Inox et métaux non ferreux.

Mod.	TPI	Diente Tooth Dent mm	L mm	I mm	📦	Nº Art.	€ pack
00240	10	2,5	280	260	5	69008	



Mod 00260

CORTE FLEXIBLE LARGO ALTO RENDIMIENTO

Long Life Long Flexible Cut
Coupe flexible longue longue durée



S123XF



TPI 10-14



Dentado fresado y ondulado con geometría especial. Sierra flexible de alto rendimiento en metal y madera con residuos de metal.

Special geometry milled teeth and wavy set. High performance flexible blade for steel and wood with metal residues.

Dents fraisés et ondulés avec géométrie spéciale. Lame flexible, haut rendement dans aciers et bois.

Mod.	TPI	Diente Tooth Dent mm	L mm	I mm	📦	Nº Art.	€ pack
00260	10-14	2,5-1,8	225	205	5	69011	



Mod 00280

RESCATE Y DESMONTAJE CORTE LARGO

Long Cut Rescue & Dismantling
Secours et démontage coupe longue



TPI 10



Dentado fresado y alterno. Sierra robusta con ancho especial para corte recto y rápido en acero, todo tipo de maderas con residuos de metal. Especial rescate y desmontaje.

Milled and side set teeth. Special thick and robust blade for fast and straight cutting of steel and all types of wood with metal residues. Especial for rescue and dismantling.

Dents fraisés et ondulés. Lame très épaisse pour coupe droite et rapide dans aciers et différents types de bois. Spéciale pour secours et démontages.

Mod.	TPI	Diente Tooth Dent mm	L mm	I mm	📦	Nº Art.	€ pack
00280	10	2,5	300	280	5	69014	



Mod 00020

REPARACIÓN PALLETS

Pallet Repair
Réparation de palettes



S922VF



Dentado fresado, ondulado y variable. Todo tipo de maderas con residuos de metales. Especial reparación de pallets.

Side set, wavy and variable tothing. All wood types with metal residues. Special for pallet repair.

Denture fraisée, ondulé et variable. Différents types de bois. Spéciale pour réparation de palettes.

Mod.	TPI	Diente Tooth Dent mm	L mm	I mm	Icon	Nº Art.	€ pack
00020	10-14	2,5-1,8	150	130	5	18874	



Mod 00030

REPARACIÓN PALLETS CORTE LARGO

Long Cut Pallet Repair
Réparation de palettes coupe longue



S1122VF



Dentado fresado, ondulado y variable. Todo tipo de maderas con residuos de metales. Especial reparación de pallets.

Side set, wavy and variable tothing. All wood types with metal residues. Special for pallet repair.

Denture fraisée, ondulé et variable. Différents types de bois. Spéciale pour réparation de palettes.

Mod.	TPI	Diente Tooth Dent mm	L mm	I mm	Icon	Nº Art.	€ pack
00030	10-14	2,5-1,8	225	205	5	18875	



Mod 00040

CORTE FLEXIBLE RECTO RÁPIDO ALTO RENDIMIENTO

Long Life Fast Straight Flexible Cut
Coupe flexible droite rapide longue durée



S611DF



Dentado fresado y avoado. Sierra flexible para corte recto y rápido en todo tipo de maderas y plásticos. Alto rendimiento.

Side set, milled teeth. Flexible blade for fast and straight cutting of all types of woods and plastics. Long lifetime.

Denture fraisée et avoyée. Lame flexible pour coupe droite et rapide dans différents types de bois et plastiques. Durée de vie plus longue.

Mod.	TPI	Diente Tooth Dent mm	L mm	I mm	📦	Nº Art.	€ pack
00040	6	4,2	150	130	5	18876	

Mod 00060

CORTE EXTRA LARGO FLEXIBLE RECTO RÁPIDO ALTO RENDIMIENTO

Long Life Fast Straight Flexible Extra Long Cut
Coupe extra longue flexible droite rapide longue durée

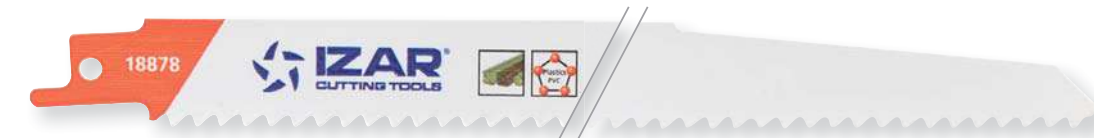

S1411DF



Dentado fresado y avoado. Sierra flexible para corte recto y rápido en todo tipo de maderas y plásticos. Alto rendimiento.

Side set, milled teeth. Flexible blade for fast and straight cutting of all types of woods and plastics. Long lifetime.

Denture fraisée et avoyée. Lame flexible pour coupe droite et rapide dans différents types de bois et plastiques. Durée de vie plus longue.

Mod.	TPI	Diente Tooth Dent mm	L mm	I mm	📦	Nº Art.	€ pack
00060	6	4,2	300	280	5	18878	



Mod 00200

DENTADO TUNGSTENO

Tungsten Teeth
Denture Tungstène



S1141HM

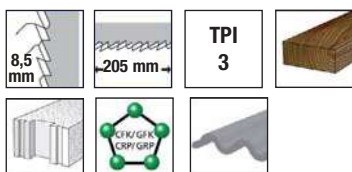

Dentado de tungsteno. Especial madera dura, hormigón poroso y productos reforzados con fibra de vidrio.

Side set, milled teeth. Special for hard wood, gas-formed concrete and glass-fibre reinforced products.

Denture fraisée et avoyée. Spéciale pour bois durs, bétons et matières plastiques renforcées avec fibres de verre.

Mod.	TPI	Diente Tooth Dent mm	L mm	I mm		Nº Art.	€ pack
00200	3	8,5	225	205	1	69017	



Mod 00210

DENTADO TUNGSTENO CORTE LARGO

Long Cut Tungsten Teeth
Denture Tungstène coupe longue



S1241HM

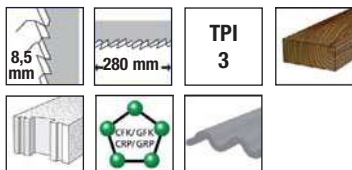

Dentado de tungsteno. Especial madera dura, hormigón poroso y productos reforzados con fibra de vidrio.

Side set, milled teeth. Special for hard wood, gas-formed concrete and glass-fibre reinforced products.

Denture fraisée et avoyée. Spéciale pour bois durs, bétons et matières plastiques renforcées avec fibres de verre.

Mod.	TPI	Diente Tooth Dent mm	L mm	I mm		Nº Art.	€ pack
00210	3	8,5	300	280	1	69019	



Mod 00260

DEMOLICIÓN CORTE LARGO TCT

TCT Long Cut Demolition
Démolition coupe longue TCT



S1243HM



215 mm

Dentado de tungsteno. Especial bloques de hormi-
gón poroso, ladrillo, fibrocemento.

Tungsten teeth. Special for aerated concrete
blocks, brick, fibre cement.

Denture Tungstène. Spécial pour blocs de béton
cellulaire, brique, amiante-ciment.

Mod.	TPI	Diente Tooth Dent mm	L mm	I mm		Nº Art.	€ pack
00260	2	12,7	305	250	1	72626	



Mod 00270

DEMOLICIÓN CORTE EXTRA LARGO TCT

TCT Extra Long Cut Demolition
Démolition coupe extra longue TCT



S2243HM



365 mm

Dentado de tungsteno. Especial bloques de hormi-
gón poroso, ladrillo, fibrocemento.

Tungsten teeth. Special for aerated concrete
blocks, brick, fibre cement.

Denture Tungstène. Spécial pour blocs de béton
cellulaire, brique, amiante-ciment.

Mod.	TPI	Diente Tooth Dent mm	L mm	I mm		Nº Art.	€ pack
00270	2	12,7	455	400	1	72627	



Mod 00220

HIELO Y COMIDA CONGELADA

Ice & Frozen Food
Glaces et produits surgelés



S1211K



Dentado fresado y alterno de acero inoxidable. Especial comida congelada, hielo y madera.

Side set, milled teeth. Special for frozen food, ice and wood.

Denture fraisée et avoyée. Spéciale pour produits surgelés, glaces et bois.

Mod.	TPI	Diente Tooth Dent mm	L mm	I mm		Nº Art.	€ pack
00220	4	6,35	300	280	1	69020	



Mod 00240

CORTE RÁPIDO MUY LIMPIO AISLAMIENTO

Insulation Very Clean Fast Cut
Coupe rapide très propre isolant



S1213AWP



HCS / CV



Dentado ondulado doble. Corte rápido y muy limpio en lana de roca, espuma, poliestireno, cuero, caucho, papel, cartón, alfombra.

Side set, milled teeth. Fast and very clean cutting of mineral rock wool, foam, polystyrene, rubber, paper, carton, carpet.

Denture fraisée et avoyée. Coupe rapide et très précise dans mousses, polystyrène, cuirs, caoutchouc, papiers, cartons, tapis.

Mod.	L mm	I mm		Nº Art.	€ pack
00240	300	280	5	69024	



Mod 00300

MANGO MULTIHERRAMIENTA

Multi Tool Handle
Queue multi-outils



HCS / CV

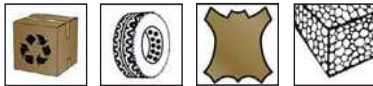

Espuma / Poliestireno
Foam / Polystyrene
Mousse / Polystyrène

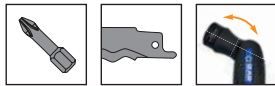

MANGO MULTIHERRAMIENTA 2 en 1: atornillar y serrar

- Mango inclinable, facilita la transmisión de la fuerza
- Para lugares de difícil acceso
- Apto para sierras de sable y puntas de atornillar estándar
- Depósito para 6 puntas de atornillos (no incluidas)
- Fácil cambio de herramienta gracias a su anillo de montaje giratorio.
- Apto para uso manual en madera con Ref. 1950 mod. 00020, en metal con Ref. 1920 mod. 00200, en aislamiento y otros materiales con Ref. 1960 mod. 00240 y mod. 00280.

MULTITOOL HANDLE 2 in 1: screw and saw

- Inclinable handle for better power transmission
- Useful at places which are difficult to Access/reach
- Suitable for reciprocating saw blades and standard screw bits
- Bit magazine for 6 bits (not included)
- Easy tool change by means of a/its rotating mounting ring
- Suitable for manual use in wood with Ref. 1950 mod. 00020, in metal with Ref. 1920 mod. 00200 and in insulation and other materials with Ref. 1960 mod. 00240 and mod. 00280.

QUEUE MULTI-OUTILS 2 en 1: viser et serrer

- Queue réclinable: il rend plus facile la transmission des forces
- Pour des endroits de difficile accès
- Convenable pour scies sabres et embouts standards
- Capacité 6 embouts (pas compris)
- Changement d'outil facile grace à sa bague de montage rotative
- Conseillé pour utilisation à main en bois avec ref. 1950 mod. 00020, en métal avec ref. 1920 mod. 00200, en isolation et autres matériaux avec mod. 00240 et mod. 00280.

Mod.	Cont.		Nº Art.	€ pack
00300	1 x Mango / Handle / Queue 1 x Ref. 1960 - 00240 (Art. 69024) l=280 S1213AWP 1 x Ref. 1960 - 00280 (Art. 76688) l=205 S1113AWP	1	72851	

Línea 1 m 19SS - Refs. 1920 - 1950 - 1960

SIERRAS SABLE
Sabre Saw Blades
Lames scie sabre



Ref.	1920	1920	1920	1950	1950	1950	1960	1960	1960	1960
	00020	00030	00050	00010	00020	00030	00020	00030	00040	00060
Pcs	3	3	3	3	3	3	3	3	3	3

Ref. 4995 - Nº Art. 72191: €



CUADRO USO SIERRAS CALAR

Jig Saw Blade Use Table

Tableau utilisation lames scies sauteuses

● **Ideal**
● Ideal - Idéal

○ **Adecuado**
○ Suitable - Convenable

MADERA - Wood - Bois

PLÁSTICOS

Todos tipos
All types
Toutes sortes



Aglomerado lami-
nado
Laminated chipboard
Panneau revêtu
Blandita
Tendre



Dura
Hard
Dur



Contrachapado
Plywood
Contreplaqué



Parquet laminado
Laminated parquet
Parquet laminié



Con clavos
With nails
Avec clous



Agglomerado
Chipboard
Panneau



Plásticos
Plastics
Plastiques



Reforzados
fibra carbon
Carbon fibre
Reinforced
fibre-carbone





Madera
Wood - Bois

Ref. - Mod.	Equiv.	Mat.	TPI	l mm	Pág.										
1940 010	T119B	HCS/CV	13	50	398										
020	T119BO	HCS/CV	13	50	398										
030	T111C	HCS/CV	8,5	75	399										
040	T144D	HCS/CV	6,35	75	399	●									
050	T244D	HCS/CV	6,35	75	400	●									
060	T101B	HCS/CV	10	75	400	●									
070	T101BR	HCS/CV	10	75	401	●									
080	T101D	HCS/CV	6,35	75	401	●									
090	T301CD	HCS/CV	8,5	105	402	●									
100		HCS/CV	10	75	402		●								
110	T144DF	Bi-metal	6,35	75	403	●									
130	T344D	HCS/CV	6,35	105	403	●									
140	T234X	Bi-metal	10	91	404	●									
150	T345XF	Bi-metal	10-14	105	404	○									
160		HCS/CV	6,35	75	405	●									
170	T308BCP	HCS/CV	13	105	405		●								
180	T301B	HCS/CV	10	91	406	●									
200	T744D	HCS/CV	6,35	155	406	●									

Metal
Metal - Métal

1910 020	T118A	HSS	21	55	407										
040	T318A	HSS	25	105	407										
050	T118B	HSS	13	55	408										
060	T318B	HSS	14	105	408										
070	T118AF	Bi-metal	21	55	409										
090	T118BF	Bi-metal	13	55	409										
100	T318BF	Bi-metal	14	105	410										
110	T127D	HSS	8,5	75	410										
120	T118AHM	CV-HM	23	50	411										
200	T718AF	Bi-metal	12	155	411										

Especial
Special

1930 020	T127DF	Bi-metal	8,5	75	412										
030	T130RIFF	CV-HM		54	412										
200	T341HM	CV-HM	6	105	412										

Madera
Wood - Bois

1945 00040	U144D	HCS/CV	6,35	75	413	●									
060	U101B	HCS/CV	10	75	414	●									
00070	U101BR	HCS/CV	10	75	414	●									

Metal
Metal

1915 00020	U118A	HSS	21	55	415										
00070	U118AF	Bi-metal	21	55	415										
00110	U127D	Bi-metal	8,5	75	415										



SIERRAS CALAR

Jig Saw Blades

Lames scies sauteuses

Ref. **1940**

MADERA Wood Bois

Mod **010**

BÁSICA CORTE RECTO

Basic Straight Cut
Basique coupe droite

T119B

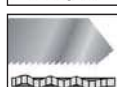

Mod.	TPI	Diente Tooth Dent mm	L mm	I mm		Nº Art.	€ pack
010	13	2	76	50	3	14129	

Dentado fresado y ondulado. Corte recto y limpio en madera blanda, madera contrachapada, tabla de viruta prensada, madera estratificada, tablero de fibra y materiales de aislamiento.

Milled teeth and wavy set. Straight and clean cutting of soft wood, plywood, chipboard, wood core plywood, fibre board and insulation materials.

Dents fraisés et ondulés. Coupe droite et propre dans bois tendres, contre-plaqués, agglomérés, fibres et matériaux d'isolation.



Mod **020**

BÁSICA CORTE CURVO

Basic Curve Cut
Basique coupe courbe

T119BO

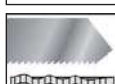

Mod.	TPI	Diente Tooth Dent mm	L mm	I mm		Nº Art.	€ pack
020	13	2	76	50	3	14138	

Dentado fresado y ondulado. Corte curvo y limpio en madera blanda, madera contrachapada, tabla de viruta prensada, madera estratificada, tablero de fibra y materiales de aislamiento.

Milled teeth and wavy set. Curve and clean cutting of soft wood, plywood, chipboard, wood core plywood, fibre board and insulation materials.

Dents fraisés et ondulés. Coupe courbe et propre dans bois tendres, contre-plaqués, agglomérés, fibres et matériaux d'isolation.



Mod 030

BÁSICA CORTE BASTO

Basic Rough Cut
Basique coupe gros



T111C

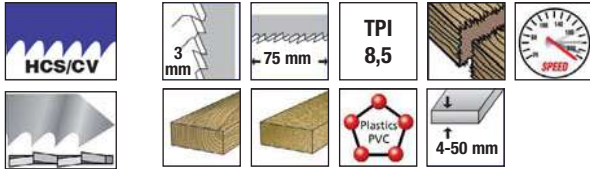

Dentado alterno. Corte basto y rápido en madera blanda, tabla de viruta prensada, madera estratificada, tablero de fibra y plástico.

Side set toothing. Rough and fast cutting of soft wood, chipboard, wood core plywood, fibre board and plastics.

Denture avoyée et affûtée. Coupe grosso et rapide dans bois tendres, agglomérés, fibres et plastiques.

Mod.	TPI	Diente Tooth Dent mm	L mm	I mm	№ Art.	€ pack
030	8,5	3	100	75	3 14221	



Mod 040

CORTE RÁPIDO

Fast Cut
Coupe rapide



T144D

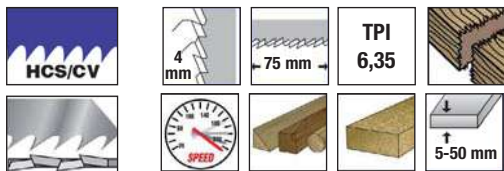

Dentado alterno y afilado diagonal. Corte rápido en todo tipo de maderas.

Side set and diagonally sharpened toothing. Fast cutting for all wood types.

Denture avoyée, dépouillée et affûtée. Coupe rapide dans différents types de bois.

Mod.	TPI	Diente Tooth Dent mm	L mm	I mm	№ Art.	€ pack
040	6,35	4	100	75	3 14230	



Mod 050

CORTE RÁPIDO CURVO

Curve Fast Cut
Coupe rapide courbe

T244D

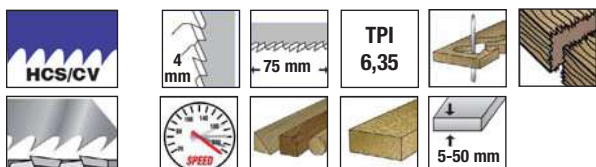

Dentado alterno y afilado diagonal. Corte rápido y curvo en todo tipo de maderas.

Side set and diagonally sharpened toothing. Fast and curve cutting for all wood types.

Denture avoyée, dépoillée et affûtée. Coupe rapide et courbe dans différents types de bois.



Mod.	TPI	Diente Tooth Dent mm	L mm	I mm	3	Nº Art.	€ pack
050	6,35	4	100	75	3	14231	

Mod 060

CORTE LIMPIO

Clean Cut
Coupe propre

T101B

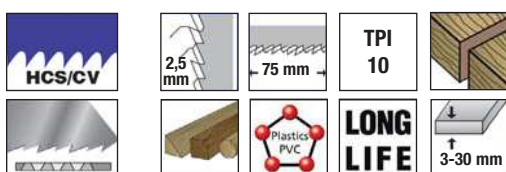

Sierra rectificaco cónico y dentado afilado diagonal. Corte limpio en todo tipo de maderas y plásticos.

Conically ground blade with diagonally sharpened teeth. Clean cutting for all wood types and plastics.

Corps de la lame conique et denture dépoillée et affûtée. Coupe propre dans différents types de bois et plastiques.



Mod.	TPI	Diente Tooth Dent mm	L mm	I mm	3	Nº Art.	€ pack
060	10	2,5	100	75	3	14233	



Mod 070

CORTE LIMPIO SIN ASTILLAS

Splinterfree Clean Cut
Coupe propre sans éclat



T101BR

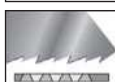

Sierra rectificado cónico y dentado afilado diagonal. Dentado inverso. Corte limpio sin astillas en todo tipo de maderas y plásticos.

Conically ground blade with diagonally sharpened teeth. Reverse teeth. Clean splinterfree cutting for all wood types and plastics.

Corps de la lame conique et denture dépouillée et affûtée. Denture inversée. Coupe propre sans éclats dans différents types de bois et plastiques.

Mod.	TPI	Diente Tooth mm	Dent mm	L mm	I mm	№ Art.	€ pack
070	10	2,5	2,5	100	75	3 14236	



Mod 080

CORTE LIMPIO RÁPIDO

Fast Clean Cut
Coupe propre rapide



T101D

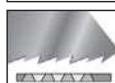

Sierra rectificado cónico y dentado afilado diagonal. Corte limpio y rápido en todo tipo de maderas y plásticos.

Conically ground blade with diagonally sharpened teeth. Clean and fast cutting for all wood types and plastics.

Corps de la lame conique et denture dépouillée et affûtée. Coupe propre et rapide dans différents types de bois et plastiques.

Mod.	TPI	Diente Tooth mm	Dent mm	L mm	I mm	№ Art.	€ pack
080	6,35	4	4	100	75	3 14243	



Mod 100

CORTE LIMPIO CURVO

Curve Clean Cut
Coupe propre courbe

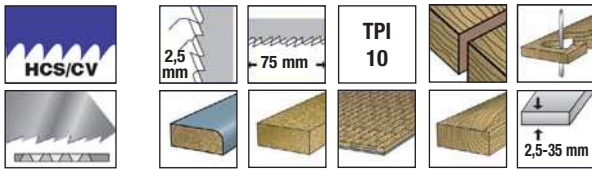

Sierra rectificado cónico y dentado afilado diagonal. Corte limpio y curvo en madera blanda, aglomerado, laminado, parqué.

Conically ground blade with diagonally sharpened teeth. Clean and curve cutting for soft wood, chipboard, laminated board, parquet.

Corps de la lame conique et denture dépouillée et affûtée. Coupe propre et courbe dans bois tendres, agglomérés, panneaux en bois, parquets.

Mod.	TPI	Diente Tooth mm	Dent mm	L mm	I mm	Nº Art.	€ pack
100	10	2,5		100	75	3 14302	



Mod 090

CORTE LIMPIO LARGO

Long Clean Cut
Coupe propre longue



T301CD

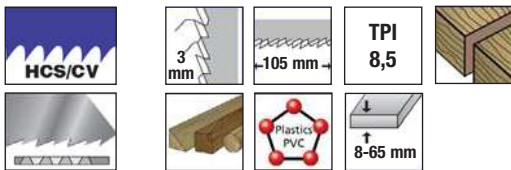

Sierra rectificado cónico y dentado afilado diagonal. Corte limpio y largo en todo tipo de maderas y plásticos.

Conically ground blade with diagonally sharpened teeth. Clean and long cutting for all wood types and plastics.

Corps de la lame conique et denture dépouillée et affûtée. Coupe propre et longue dans différents types de bois et plastiques.

Mod.	TPI	Diente Tooth mm	Dent mm	L mm	I mm	Nº Art.	€ pack
090	8,5	3		132	105	3 14246	



Mod 110

CORTE RÁPIDO ALTO RENDIMIENTO

Long Life Fast Cut
Coupe rapide longue durée

T144DF

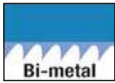

Dentado alterno y afilado diagonal. Corte rápido en todo tipo de maderas. Alto rendimiento.

Side set and diagonally sharpened toothing. Fast cutting for all wood types. Long lifetime.

Denture avoyée, dépouillée et affûtée. Coupe rapide dans différents types de bois. Durée de vie plus longue.

Mod.	TPI	Diente Tooth mm	Dent mm	L mm	I mm	📦 N° Art.	€ pack
110	6,35	4		100	75	3 14306	

Mod 130

CORTE RÁPIDO LARGO

Long Fast Cut
Coupe rapide longue

T344D



Dentado alterno y afilado diagonal. Corte rápido y largo en todo tipo de maderas.

Side set and diagonally sharpened toothing. Fast and long cutting for all wood types.

Denture avoyée, dépouillée et affûtée. Coupe rapide et longue dans différents types de bois.

Mod.	TPI	Diente Tooth mm	Dent mm	L mm	I mm	📦 N° Art.	€ pack
130	6,35	4		132	105	3 14307	



Mod 140

CORTE LIMPIO RÁPIDO

Fast Clean Cut
Coupe propre rapide



T234X

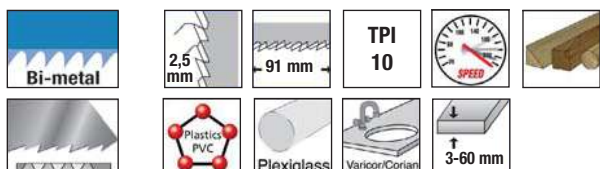

Sierra rectificado cónico y dentado afilado triple. Corte limpio y rápido en todo tipo de maderas y plásticos.

Conically ground blade with 3-times sharpened teeth. Clean and fast cutting for all wood types and plastics.

Corps de la lame conique avec denture affûtée triple. Coupe propre et rapide dans différents types de bois et plastiques.

Mod.	TPI	Diente Tooth Dent mm	L mm	I mm		Nº Art.	€ pack
140	10	2,5	117	91	3	14326	



Mod 150

CORTE LARGO FLEXIBLE ALTO RENDIMIENTO

Long Life Flexible Long Cut
Coupe longue flexible longue durée



T345XF

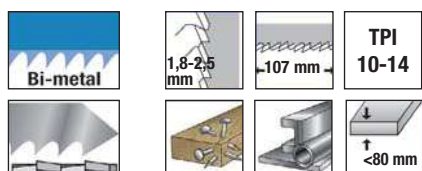

Dentado fresado alterno. Sierra larga y flexible para madera con residuos de metal, tubos y perfiles de acero (2,5-10 mm). Gran rendimiento.

Milled and side teeth. Long and flexible blade for wood with metal residues, steel pipes and profiles (2,5-10 mm). Long lifetime.

Dents fraisés et avoyés. Lame très longue et flexible pour bois avec métaux résiduels, tubes et profils en acier (2,5-10 mm). Durée de vie plus longue.

Mod.	TPI	Diente Tooth Dent mm	L mm	I mm		Nº Art.	€ pack
150	10-14	1,8-2,5	132	107	3	14327	

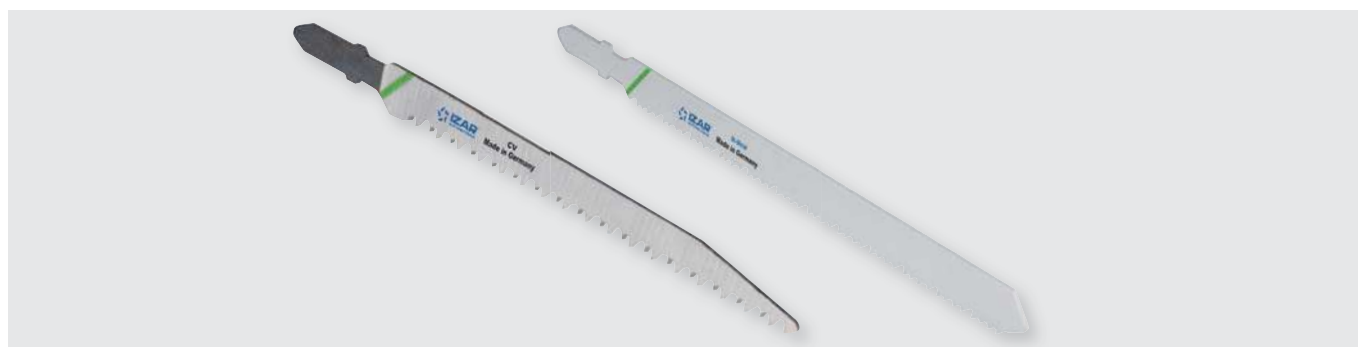

Mod 160

CORTE RÁPIDO CURVO

Curve Fast Cut
Coupe rapide courbe

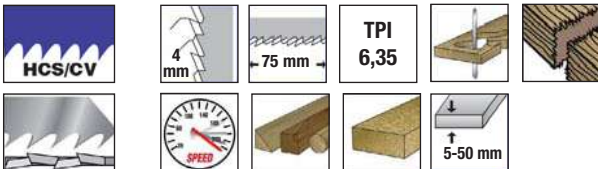

Dentado doble alterno y afilado diagonal. Corte rápido y curvo en todo tipo de maderas.

Double side set and diagonally sharpened toothing. Fast and curve cutting for all wood types.

Denture double avoyée, dépouillée et affûtée. Coupe rapide et courbe dans différents types de bois.

Mod.	TPI	Diente Tooth Dent mm	L mm	I mm	3	Nº Art.	€ pack
160	6,35	4	100	75	3	14328	



Mod 170

CORTE LIMPIO RÁPIDO

Fast Clean Cut
Coupe propre rapide

T308BCP

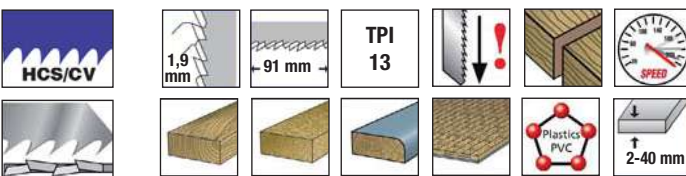

Sierra rectificadо cónico y dentado afilado inverso. Corte limpio y rápido en madera blanda, aglomerado, tablero de fibra, laminado, parqué, laminado plástico.

Conically ground blade with reverse sharpened teeth. Clean and fast cutting for all wood types and plastics.

Corps de la lame conique denture renversée et affûtée. Coupe propre et rapide dans différents types de bois et plastiques.

Mod.	TPI	Diente Tooth Dent mm	L mm	I mm	3	Nº Art.	€ pack
170	13	1,9	117	91	3	14331	



Mod 180

CORTE LIMPIO

Clean Cut
Coupe propre



T301B

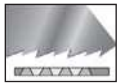

Sierra rectificado cónico y dentado afilado diagonal. Corte limpio en todo tipo de maderas y plásticos.

Conically ground blade with diagonally sharpened teeth. Clean cutting for all wood types and plastics.

Corps de la lame conique denture dépouillée et affûtée. Coupe propre dans différents types de bois et plastiques.

Mod.	TPI	Diente Tooth Dent mm	L mm	I mm		Nº Art.	€ pack
180	10	2,5	132	105	3	14332	



Mod 200

CORTE RÁPIDO MUY LARGO

Very Long Fast Cut
Coupe rapide très longue



T744D



Dentado alterno y afilado diagonal. Corte rápido y muy largo en todo tipo de maderas.

Side set and diagonally sharpened toothing. Fast and very long cutting for all wood types.

Denture avoyée, dépouillée et affûtée. Coupe rapide et très longue dans différents types de bois.

Mod.	TPI	Diente Tooth Dent mm	L mm	I mm		Nº Art.	€ pack
200	6,35	4	180	155	3	14334	



Mod 020

CORTE LÁMINAS FINAS ACERO

Thin Steel Sheet Cut
Coupe tôles fines acier



T118A

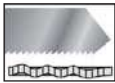

Dentado fresado y ondulado. Láminas finas de acero.

Milled teeth and wavy set. Thin steel sheets.

Dents fraisés et ondulés. Tôles fines.

Mod.	TPI	Diente Tooth Dent mm	L mm	I mm		Nº Art.	€ pack
020	21	1,2	76,5	55	3	14336	

Mod 040

CORTE LARGO LÁMINAS FINAS ACERO

Thin Steel Sheet Long Cut
Coupe longue tôles fines acier



T318A

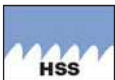

Dentado fresado y ondulado. Sierra larga para láminas finas de acero, tubos, perfiles y material tipo sandwich hasta 80 mm.

Milled teeth and wavy set. Long blade for thin steel sheets, pipes, profiles and sandwich-material up to 80 mm.

Dents fraisés et ondulés. Lame longue pour tôles fines, profils, tubes et matériel sandwich jusqu'à 80 mm.

Mod.	TPI	Diente Tooth Dent mm	L mm	I mm		Nº Art.	€ pack
040	25	1	132	105	3	14339	



Mod 050

CORTE ACEROS, NO FERROSOS, ALUMINIO

Steel, Non-Ferrous, Aluminium Cut
Coupe Aciers, Non ferreux, Aluminium



T118B

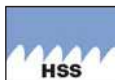

Dentado fresado y ondulado. Aceros, metales no ferrosos y aluminio.

Milled teeth and wavy set. Steel, non-ferrous metal and aluminium.

Dents fraisés et ondulés. Aciers, métaux non ferreux et aluminiums.



Mod.	TPI	Diente Tooth Dent mm	L mm	I mm		Nº Art.	€ pack
050	13	2	76,5	55	3	14349	

Mod 060

CORTE LARGO FLEXIBLE

Flexible Long Cut
Coupe longue flexible



T318B



Dentado fresado y ondulado. Sierra larga y flexible para aceros, tubos, perfiles, material tipo sandwich hasta 80 mm y metales no ferrosos. Alto rendimiento.

Milled teeth and wavy set. Long and flexible blade for steel, pipes, profiles, sandwich-material up to 80 mm and non-ferrous metals. Long life.

Dents fraisés et ondulés. Lame longue et flexible pour aciers, profils, tubes, matériel sandwich jusqu'à 80 mm et métal non ferreux. Durée de vie plus longue.



Mod.	TPI	Diente Tooth Dent mm	L mm	I mm		Nº Art.	€ pack
060	14	1,8	132	105	3	14351	



Mod 070

CORTE FLEXIBLE ALTO RENDIMIENTO

Long Life Flexible Cut
Coupe flexible longue durée



T118AF



Dentado fresado y ondulado. Sierra flexible para aceros e inoxidable. Alto rendimiento.

Milled teeth and wavy set. Flexible blade for steel and stainless steel. Long life.

Dents fraisés et ondulés. Lame longue et flexible pour aciers et inoxydables. Durée de vie plus longue.

Mod.	TPI	Diente		L mm	l mm	N° Art.	€ pack
		Tooth mm	Dent mm				
070	21	1,2	1,2	76,5	55	3 14352	

Mod 090

CORTE FLEXIBLE ALTO RENDIMIENTO

Long Life Flexible Cut
Coupe flexible longue durée



T118BF

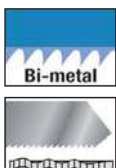

Dentado fresado y ondulado. Sierra flexible para aceros e inoxidable, metales no ferrosos y aluminio. Alto rendimiento.

Milled teeth and wavy set. Flexible blade for steel and stainless steel, non-ferrous metals and aluminium. Long life.

Dents fraisés et ondulés. Lame longue et flexible pour aciers et inoxydables, métaux non ferreux et aluminium. Durée de vie plus longue.

Mod.	TPI	Diente		L mm	l mm	N° Art.	€ pack
		Tooth mm	Dent mm				
090	13	2	2	76,5	55	3 14353	



Mod 100

CORTE LARGO FLEXIBLE ALTO RENDIMIENTO

Long Life Flexible Long Cut
Coupe longue flexible longue durée



T318BF



Dentado fresado y ondulado. Sierra larga y flexible para aceros, tubos, perfiles, material tipo sandwich hasta 80 mm y metales no ferrosos. Alto rendimiento.

Milled teeth and wavy set. Long and flexible blade for steel, pipes, profiles, sandwich-material up to 80 mm and non-ferrous metals. Long life.

Dents fraisés et ondulés. Lame longue et flexible pour aciers, profils, tubes, matériel sandwich jusqu'à 80 mm et métaux non ferreux. Durée de vie plus longue.

Mod.	TPI	Diente Tooth Dent mm	L mm	I mm		Nº Art.	€ pack
100	14	1,8	132	105	3	14358	



Mod 110

CORTE ACEROS, NO FERROSOS, ALUMINIO, PLÁSTICO

Steel, Non-Ferrous, Aluminium, Plastic Cut
Coupe Aciers, Non ferreux, Aluminium, Plastique



T127D

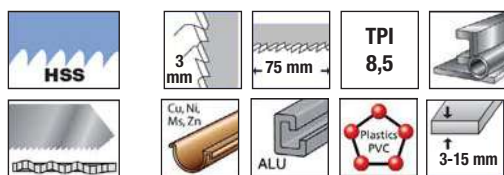

Dentado fresado alterno. Aceros, metales no ferrosos, aluminio y plásticos.

Milled teeth and side set. Steel, non-ferrous metals, aluminium and plastics.

Dents fraisés et avoyés. Aciers, métaux non ferreux, aluminiums et plastiques.

Mod.	TPI	Diente Tooth Dent mm	L mm	I mm		Nº Art.	€ pack
110	8,5	3	100	75	3	14372	



Mod 120

METAL DURO PULVERIZADO

Grinded Carbide
Carbure pulvérisé



T118AHM



Banda de metal duro pulverizado. Aceros, planchas de metal e inoxidables.

Grinded carbide strip. Steel, metal sheets and stainless steel.

Dents en carbure. Aciers, tôles et aciers inoxydables.

Mod.	TPI	Diente Tooth Dent mm	L mm	I mm	Icon	Nº Art.	€ pack
120	23	1,1	79	50	1	14379	



Mod 200

CORTE LARGO FLEXIBLE CONSTRUCCIÓN ALTO RENDIMIENTO

Long Life Construction Flexible Long Cut
Coupe longue flexible construction longue durée



T718AF



Dentado fresado y ondulado. Sierra larga y flexible para construcción de fachadas y material tipo sandwich. Alto rendimiento.

Milled teeth and wavy set. Long and flexible blade for facade construction and sandwich-material. Long life.

Dents fraisées et ondulés. Lame longue et flexible pour les façades et matériel sandwich. Durée de vie plus longue

Mod.	TPI	Diente Tooth Dent mm	L mm	I mm	Icon	Nº Art.	€ pack
200	12	2	180	155	3	14380	



Mod 020

CORTE FLEXIBLE METAL, PLÁSTICO

Plastic, Metal Flexible Cut
Coupe flexible Métal, Plastique



T127DF

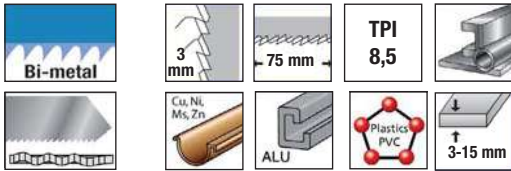

Mod.	TPI	Diente Tooth Dent mm	L mm	I mm	Nº Art.	€ pack
020	8,5	3	100	75	3	14386

Dentado fresado alterno. Sierra flexible para aceros, metales no ferrosos, aluminio (3-15 mm) y plásticos (3-30 mm).

Milled teeth and side set. Flexible blade for steel, non-ferrous metals, aluminium (3-15 mm) and plastics (3-30 mm).

Dents fraisés et avoyés. Lame flexible pour aciers, métaux non ferreux, aluminiums (3-15 mm) et plastiaques (3-30 mm).



Mod 030

CORTE VIDRIO, CERÁMICA

Ceramic, Glass Cut
Coupe Verre, Céramique



T130RIFF



Mod.	L mm	I mm	Nº Art.	€ pack
030	79	54	1	14387

Recubrimiento de metal duro de grano grueso. Vidrio, cerámica y productos reforzados con fibra de vidrio.

Carbide coated, coarse-grained. Glass, ceramics, glass-fibre reinforced products.

Revêtement en carbure, gros grains. Verre, céramique, fibre de verre.



Mod 200

DENTADO METAL DURO TUNGSTENO

Tungsten Carbide Teeth
Denture carbure Tungstène



T341HM

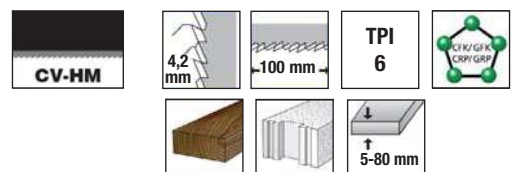

Mod.	TPI	Diente Tooth Dent mm	L mm	I mm	Nº Art.	€ pack
200	6	4,2	132	100	1	14390

Dentado metal duro tungsteno. Fibra de vidrio, madera dura y hormigón gaseoso.

Carbide coated, coarse-grained. Glass-fibre, hard wood and gas formed concrete.

Revêtement en carbure, gros grains. Fibre de verre, bois durs et béton.



Mod 00040

CORTE RÁPIDO

Fast Cut
Coupe rapide



U144D



Dentado alterno y afilado diagonal. Corte rápido en todo tipo de maderas.

Side set and diagonally sharpened tothing. Fast cutting for all wood types.

Denture avoyée, dépouillée et affûtée. Coupe rapide dans différents types de bois.



Mod.	TPI	Diente		L mm	I mm	N° Art.	€ pack
		Tooth mm	Dent mm				
00040	6,35	4	4	100	75	5 21884	

Mod 060

CORTE LIMPIO

Clean Cut
Taglio pulito



U101B

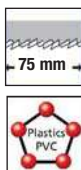
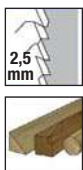

Sierra rectificado cónico y dentado afilado diagonal. Corte limpio en todo tipo de maderas y plásticos.

Conically ground blade with diagonally sharpened teeth. Clean cutting for all wood types and plastics.

Corps de la lame conique et denture dépouillée et affûtée. Coupe propre dans différents types de bois et plastiques.

Mod.	TPI	Diente Tooth Dent mm	L mm	I mm		Nº Art.	€ pack
00060	10	2,5	100	75	3	86734	



Mod 00070

CORTE LIMPIO SIN ASTILLAS

Splinterfree Clean Cut
Coupe propre sans éclat



U101BR

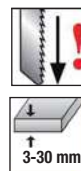
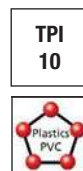
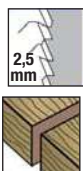
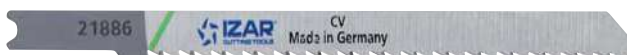

Sierra rectificado cónico y dentado afilado diagonal. Dentado inverso. Corte limpio sin astillas en todo tipo de maderas y plásticos.

Conically ground blade with diagonally sharpened teeth. Reverse teeth. Clean splinterfree cutting for all wood types and plastics.

Corps de la lame conique et denture dépouillée et affûtée. Denture inversée. Coupe propre sans éclats dans différents types de bois et plastiques.

Mod.	TPI	Diente Tooth Dent mm	L mm	I mm		Nº Art.	€ pack
00070	10	2,5	100	75	5	21886	



Mod 00020

CORTE LÁMINAS FINAS ACERO

Thin Steel Sheet Cut
Coupe tôles fines acier



U118A



Dentado fresado y ondulado. Láminas finas de acero e inoxidable.

Milled teeth and wavy set. Thin steel and stainless steel sheets.

Dents fraisés et ondulés. Tôles fines en acier et inoxyable.

Mod.	TPI	Diente Tooth Dent mm	L mm	I mm	N° Art.	€ pack
00020	21	1,2	76,5	55	5 21892	

Hasta fin de existencias / While stock lasts / Jusqu'à la fin de stock



Mod 00070

CORTE FLEXIBLE ALTO RENDIMIENTO

Long Life Flexible Cut
Coupe flexible longue durée



U118AF

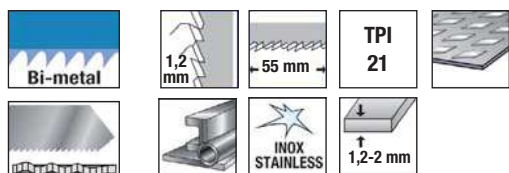

Dentado fresado y ondulado. Sierra flexible para aceros e inoxidables. Alto rendimiento.

Milled teeth and wavy set. Flexible blade for steel and stainless steel. Long life.

Dents fraisés et ondulés. Lame longue et flexible pour aciers et inoxyables. Durée de vie plus longue.

Mod.	TPI	Diente Tooth Dent mm	L mm	I mm	N° Art.	€ pack
00070	21	1,2	76,5	55	5 21893	



Mod 00110

CORTE ACEROS, NO FERROSOS, ALUMINIO, PLÁSTICO

Steel, Non-Ferrous, Aluminium, Plastic Cut
Coupe Aciers, Non ferreux, Aluminium, Plastique



U127D



Dentado fresado alterno. Aceros, metales no ferrosos, aluminio y plásticos.

Milled teeth and side set. Steel, non-ferrous metals, aluminium and plastics.

Dents fraisés et avoyés. Aciers, métaux non ferreux, aluminiums et plastiques.

Mod.	TPI	Diente Tooth Dent mm	L mm	I mm	N° Art.	€ pack
00110	8,5	3	100	75	5 21894	



Línea 1 m 19C1 - Refs. 1910 - 1930 - 1940

SIERRAS CALAR INSERCIÓN "T"

"T" Insertion Jig Saw Blades - Lames scies insertion "T"

23
cm



Ref.	1910	1910	1910	1910	1910	1910	1910	1910	1910	1930	1930	1940	1940	1940	1940	1940	1940	1940	1940	1940
	020	040	050	060	070	090	100	110	020	030	010	020	030	040	050	060	070	080	100	
Pcs	5	5	5	5	5	5	5	5	5	5	5	5	5	5	5	5	5	5	5	5

Ref. 4995 - N° Art. 72195: €

Línea 1 m 19C2 - Refs. 1910 - 1915 - 1940 - 1945

SIERRAS CALAR INSERCIÓN "T" + "U"

"T" + "U" Insertion Jig Saw Blades - Lames scies insertion "T" + "U"

24
cm



Ref.	1910	1910	1910	1910	1910	1915	1915	1940	1940	1940	1940	1940	1940	1940	1940	1945	1945	1945	1945
	020	040	050	070	100	00070	00110	010	030	040	060	070	080	100	140	00030	00040	00060	00070
Pcs	5	5	5	5	5	5	5	5	5	5	5	5	5	5	5	5	5	5	5

Ref. 4995 - N° Art. 72196: €

Display 20 - Refs. 1940 - 1930 - 1910

SIERRAS CALAR INSERCIÓN "T"

"T" Insertion Jig Saw Blades - Lames scies insertion "T"



Ref. 1940								
Mod.	Mod. 010	Mod. 020	Mod. 030	Mod. 030	Mod. 040	Mod. 040	Mod. 050	Mod. 060
Pcs	3	3	2	1	2	1	3	2
Ref. 1940					Ref. 1930			
Mod.	Mod. 060	Mod. 070	Mod. 070	Mod. 080	Mod. 100	Mod. 020	Mod. 030	Mod. 200
Pcs	1	2	1	3	3	3	3	3
Ref. 1910								
Mod.	Mod. 020	Mod. 040	Mod. 050	Mod. 060	Mod. 070	Mod. 090	Mod. 100	Mod. 110
Pcs	3	3	3	3	3	3	3	3

Ref. 4995 - N° Art. 22391: €

Display 21 - Refs. 1940 - 1910 - 1930 - 1945 - 1915

SIERRAS CALAR INSERCIÓN "T" + "U"

"T" + "U" Insertion Jig Saw Blades - Lames scies insertion "T" + "U"



Ref. 1940								
Mod.	Mod. 010	Mod. 030	Mod. 040	Mod. 060	Mod. 070	Mod. 080	Mod. 100	Mod. 140
Pcs	3	3	3	3	3	3	3	3
Ref. 1910					Ref. 1930			
Mod.	Mod. 020	Mod. 040	Mod. 050	Mod. 070	Mod. 100	Mod. 020	Mod. 030	Mod. 200
Pcs	2	2	2	2	2	1	1	1
Ref. 1945					Ref. 1915			
Mod.	Mod. 00030	Mod. 00040	Mod. 00060	Mod. 00060	Mod. 00070	Mod. 00070	Mod. 00070	Mod. 00110
Pcs	3	3	2	1	3	2	2	2

Ref. 4995 - N° Art. 22280: €



06.

PUNTAS ATORNILLAR

Screwdriver Bits

Embouts vissage



PUNTAS ATORNILLAR

Screwdriver Bits

Embouts vissage

Ref. **1520**

PUNTA ATORNILLAR

Screwdriver Bit
Embout vissage

Standard d = 6,35 mm

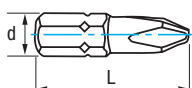

GAMA
Range
Gamme



Tipo Type	D mm	L mm	DIN	Nº Art.	€ pack	Nº Art.	€ pack	Nº Art.	€ pack	Nº Art.	€ pack	Nº Art.	€ pack
--------------	---------	---------	-----	------------	-----------	------------	-----------	------------	-----------	------------	-----------	------------	-----------

ALLEN



HEX	2	25	C 6.3	23418		23425		23426		23429			
HEX	2,5	25	C 6.3	23430		23431		23432		23433			
HEX	3	25	C 6.3	83771		33154		23445		23446			
HEX	4	25	C 6.3	83772		33155		23447		23448			
HEX	5	25	C 6.3	83773		33156		23449		23450			
HEX	6	25	C 6.3	23451		23453		23454		23455			
HEX	7	35	C 6.3	23456		23457		23458		23459			
HEX	8	35	C 6.3	23460		23461		23462		23463			

PHILLIPS



PH	0	25	C 6.3	23464		23465		23466		23468			
PH	1	25	C 6.3	83774		33138		23469		23470			
PH	2	25	C 6.3	83776		33139		23473		23475		23476	
PH	3	25	C 6.3	83778		33140		23482		23483			
PH	4	35	C 6.3	23505		23506		23509		23511			
PH	1	50	E 6.3	83775		22647		23471		23472			
PH	2	50	E 6.3	83777		22654		23477		23478		23479	
PH	3	50	E 6.3	83779		22659		23503		23504			

POZIDRIVE



PZ	0	25	C 6.3	23513		23515		23561		23562			
PZ	1	25	C 6.3	83780		33141		23570		23571			
PZ	2	25	C 6.3	83782		33142		23585		23588		23589	
PZ	3	25	C 6.3	83784		33143		23594		23596			
PZ	4	35	C 6.3	23600		23601		23602		23606			
PZ	1	50	E 6.3	83781		23578		23579		23580			
PZ	2	50	E 6.3	83783		22663		23590		23592		23593	
PZ	3	50	E 6.3	83785		22664		23597		23599			

PLANA / Flat / Plate



SL	3,0x0,5	25	C 6.3	23609		23615		23616		23618			
SL	4,0x0,5	25	C 6.3	23619		23620		23622		23624			
SL	4,5x0,6	25	C 6.3	83786		33151		23669		23672			
SL	5,5x0,8	25	C 6.3	83787		33152		23693		23702			
SL	5,5x1,0	25	C 6.3	23735		23738		23741		23750			
SL	6,0x1,0	25	C 6.3	23751		23752		23754		23755			
SL	6,5x1,2	25	C 6.3	83788		33153		23757		23758			
SL	8,0x1,2	30	C 6.3	23770		23772		23773		23774			
SL	4,0x0,5	50	E 6.3	23627		23638		23660		23663			
SL	4,5x0,6	50	E 6.3	23678		22666		23681		23683			
SL	5,5x0,8	50	E 6.3	23705		22668		23714		23723			
SL	6,5x1,2	50	E 6.3	23760		22669		23766		23769			



Ref. **1520**

PUNTA ATORNILLAR

Screwdriver Bit
Embout vissage

GAMA
Range
Gamme



Tipo Type	D mm	L mm	DIN	Nº Art.	€ pack	Nº Art.	€ pack	Nº Art.	€ pack	Nº Art.	€ pack	Nº Art.	€ pack
TX	5	25	C 6.3	23805		23806		23807		23816			
TX	6	25	C 6.3	23817		23818		23819		23820			
TX	7	25	C 6.3	23821		23822		23832		23833			
TX	8	25	C 6.3	23835	66723	23837		23837		23838			
TX	9	25	C 6.3	23848		23851		23853		23854			
TX	10	25	C 6.3	83789	33144	23855		23855		23856			
TX	15	25	C 6.3	83791	33145	23859		23859		23860		23861	
TX	20	25	C 6.3	83793	33146	23866		23866		23869		23872	
TX	25	25	C 6.3	83795	33147	23877		23877		23878		23879	
TX	27	25	C 6.3	23907	33148	23908		23908		23910			
TX	30	25	C 6.3	83797	33149	23915		23915		23919		23920	
TX	40	25	C 6.3	83799	33150	23924		23924		23925			
TX	10	50	E 6.3	83790		22671		23857		23858			
TX	15	50	E 6.3	83792		22674		23863		23864			
TX	20	50	E 6.3	83794		22675		23873		23874		23875	
TX	25	50	E 6.3	83796		22676		23894		23905		23906	
TX	27	50	E 6.3	23911		22677		23912		23913			
TX	30	50	E 6.3	83798		22678		23921		23922		23923	
TX	40	50	E 6.3	83800		22683		23926		23927			

TORX



TORX SEGURIDAD
Security Torx Sécurité



TS	10	25	C 6.3	31098		23949		23950		23951			
TS	15	25	C 6.3	31099		23952		23954		23956			
TS	20	25	C 6.3	31100		23959		23960		23961			
TS	25	25	C 6.3	31101		23962		23963		23964			
TS	27	25	C 6.3	31102		23965		23966		23967			
TS	30	25	C 6.3	31103		23970		23972		23973			
TS	40	25	C 6.3	31104		23974		23975		23998			

SQUARE ROBERTSON



SQ	1	25	C 6.3	23775		23776		23778		23779			
SQ	2	25	C 6.3	23786		23787		23788		23789			
SQ	3	25	C 6.3	23795		23796		23797		23798			
SQ	1	50	E 6.3	23781		23782		23784		23785			
SQ	2	50	E 6.3	23790		23791		23792		23794			
SQ	3	50	E 6.3	23799		23801		23802		23804			

TRIWING



TRW	1	25	C 6.3	23928		23929		23930					
TRW	2	25	C 6.3	23931		23932		23933					
TRW	3	25	C 6.3	23934		23935		23936					
TRW	4	25	C 6.3	23937		23938		23939					
TRW	5	25	C 6.3	23940		23941		23942					
TRW	6	25	C 6.3	23943		23944		23945					
TRW	8	25	C 6.3	23946		23947		23948					

XZN



XZN	4	25	C 6.3	24016		24027		24029					
XZN	5	25	C 6.3	24031		24032		24033					
XZN	6	25	C 6.3	24034		24041		24043					
XZN	8	25	C 6.3	24045		24046		24047					
XZN	10	25	C 6.3	24056		24117		24120					



Display 63 - Ref. 1520



∅	HEX 3	HEX 4	HEX 5	PH 1	PH 2	PH 3
Pcs	5	5	5	5	5	5
∅	PZ 1	PZ 2	PZ 3	SL 4,5	SL 5,5	SL 6,5
Pcs	5	5	5	5	5	5
∅	T 10	T 15	T 20	T 25	T 30	T 40
Pcs	5	5	5	5	5	5
∅	PH 1	PH 2	PH 3	PZ 1	PZ 2	PZ 3
Pcs	3	3	3	3	3	3
∅	SL 4,5	SL 5,5	SL 6,5	T 25	T 30	T 40
Pcs	3	3	3	3	3	3

Ref. 4995 - N° Art. 37502: €

Display 71 - Ref. 1520

New!



L	PZ 1	PZ 1	PH 1	PH 1	TX 10	TX 10	TX 15	TX 15	HEX 3	SL 4,5x0,6	
Pcs	5	5	5	5	5	5	5	5	5	5	
L	PZ 2	PZ 2	PH 2	PH 2	TX 20	TX 20	TX 25	TX 25	HEX 4	SL 5,5x0,8	
Pcs	5	5	5	5	5	5	5	5	5	5	
L	PZ 3	PZ 3	PH 3	PH 3	TX 30	TX 30	TX 40	TX 40	HEX 5	SL 6,5x1,2	
Pcs	5	5	5	5	5	5	5	5	5	5	
Pcs	SET			SET			SET		Quick-lock INOX	Magnético IND	Magnético IND
	3			3			3		3	3	3

Ref. 4995 - N° Art. 83801: €

Box-Pallet - Ref. 1520

New!

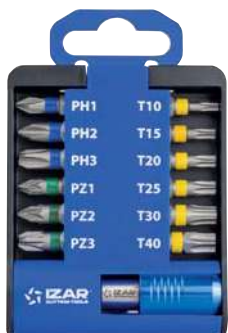

Set 13 Pcs

Cont.	N° Art.	€
PH: 1 - 2 - 3 +	83769	
PZ: 1 - 2 - 3 +		
T: 10 - 15 - 20 - 25 - 30 - 40		

12 Sets

N° Art.	€
83770	



Sets - Ref. 1520



Tipo
Type **PH-PZ-SL**

Set 12 Pcs

D mm	L mm	DIN	Nº Art.	€
PH: 1 - 2 (2 pcs.) - 3 +	25	C 6.3	33754	
PZ: 1 - 2 (2 pcs.) - 3 +				
SL: 4,5×0,6 - 5,5×0,8 - 6,5-1,2				

Hasta fin de existencias - While stock lasts - Jusqu'à la fin de stock

Box-Pallet - Ref. 1520



6 Sets

Nº Art.	€
68168	



Set 31 Pcs

Nº Art.	€
67769	

31
pcs

PH	d mm: 6,35
2x PH1	
3x PH2	
1x PH3	

PZ	d mm: 6,35
2x PZ1	
8x PZ2	
2x PZ3	

Tx	d mm: 6,35
1x T10	
2x T15	
2x T20	
3x T25	
3x T30	
1x T40	

Adapt. Quick-Lock INOX/Stainless
L mm: 60 - d mm: 6,35



Ref. **1521**

PUNTA ATORNILLAR PRO

PRO Screwdriver Bit
Embout vissage PRO



Torsion
d = 6,35 mm

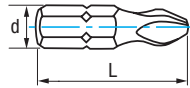

PHILLIPS



Tipo Type	D mm	L mm	DIN		Nº Art.	€ pack
PH 1	25	C 6.3	5	33173		
PH 1	50	E 6.3	3	33192		
PH 2	25	C 6.3	5	33174		
PH 2	50	E 6.3	3	33193		
PH 3	25	C 6.3	5	33175		
PH 3	50	E 6.3	3	33194		

POZIDRIVE



Tipo Type	D mm	L mm	DIN		Nº Art.	€ pack
PZ 1	25	C 6.3	5	33176		
PZ 1	50	E 6.3	3	33195		
PZ 2	25	C 6.3	5	33177		
PZ 2	50	E 6.3	3	33196		
PZ 3	25	C 6.3	5	33178		
PZ 3	50	E 6.3	3	33197		

PLANA / Flat / Plate



Tipo Type	D mm	L mm	DIN		Nº Art.	€ pack
SL 4,5x0,6	25	C 6.3	5	33186		
SL 4,5x0,6	50	E 6.3	3	33204		
SL 5,5x0,8	25	C 6.3	5	33187		
SL 5,5x0,8	50	E 6.3	3	33205		
SL 6,5x1,2	25	C 6.3	5	33188		
SL 6,5x1,2	50	E 6.3	3	33206		

TORX



Tipo Type	D mm	L mm	DIN		Nº Art.	€ pack
Tx 8	25	C 6.3	5	66725		
Tx 10	25	C 6.3	5	33179		
Tx 10	50	E 6.3	3	33198		
Tx 15	25	C 6.3	5	33180		
Tx 15	50	E 6.3	3	33199		
Tx 20	25	C 6.3	5	33181		
Tx 20	50	E 6.3	3	33200		
Tx 25	25	C 6.3	5	33182		
Tx 25	50	E 6.3	3	33201		
Tx 27	25	C 6.3	5	33183		
Tx 27	50	E 6.3	3	34144		
Tx 30	25	C 6.3	5	33184		
Tx 30	50	E 6.3	3	33202		
Tx 40	25	C 6.3	5	33185		
Tx 40	50	E 6.3	3	33203		



Ref. **1523**

PUNTA ATORNILLAR IMPACTO MANGO E6.3

Impact Screwdriver Bit E6.3 Shank
Embout visage Impact queue E6.3



New!



S2 material

60 HRC

d = 6,35 mm

- Larga vida útil
- Soporta grandes pares de torsión
- Óptimo acople entre la punta y la cabeza del tornillo
- Long life
- Suitable for high-torque
- Optimal fit between the tip and the screw head
- Longue durée de vie
- Supporte de grands couples de torsion
- Adaptation optimale entre la pointe et la tête de la vis

PHILLIPS



Tipo	L mm	DIN	Torque (Nm)		Nº Art.	€ pack
PH 1	50	E 6.3	5,00	2	58907	
PH 2	50	E 6.3	14,00	2	22807	
PH 3	50	E 6.3	33,60	2	22816	

POZIDRIVE



PZ 1	50	E 6.3	5,00	2	58910	
PZ 2	50	E 6.3	14,00	2	22818	
PZ 3	50	E 6.3	29,40	2	22820	

TORX



TX 20	50	E 6.3	12,70	2	22836	
TX 25	50	E 6.3	19,00	2	22839	
TX 30	50	E 6.3	37,40	2	22843	
TX 40	50	E 6.3	65,10	2	22845	



Ref. **1524**

PUNTA ATORNILLAR EXTRA LARGA

Extra Long Screwdriver Bit
Embout vissage extra-long

New!

Standard

d =
6,35 mm

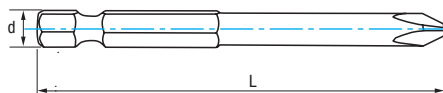

1
Uds



5
Uds

Tipo Type	D mm	L mm	DIN	Nº Art.	€ pack	Nº Art.	€ pack
--------------	---------	---------	-----	------------	-----------	------------	-----------

PHILLIPS



PH	1	75	E 6.3	23222		23225	
PH	2	75	E 6.3	23270		23271	
PH	3	75	E 6.3	23278		23279	
PH	1	100	E 6.3	23227		23229	
PH	2	100	E 6.3	23274		23275	
PH	3	100	E 6.3	23280		23281	
PH	1	150	E 6.3	23230		23231	
PH	2	150	E 6.3	23276		23277	
PH	3	150	E 6.3	23282		23283	

POZIDRIVE



PZ	1	75	E 6.3	23284		23285	
PZ	2	75	E 6.3	23290		23291	
PZ	3	75	E 6.3	23296		23297	
PZ	1	100	E 6.3	23286		23287	
PZ	2	100	E 6.3	23292		23293	
PZ	3	100	E 6.3	23298		23299	
PZ	1	150	E 6.3	23288		23289	
PZ	2	150	E 6.3	23294		23295	
PZ	3	150	E 6.3	23300		23301	

TORX



Tx	10	75	E 6.3	23330		23333	
Tx	15	75	E 6.3	23342		23351	
Tx	20	75	E 6.3	23359		23360	
Tx	25	75	E 6.3	23366		23367	
Tx	27	75	E 6.3	23384		23387	
Tx	30	75	E 6.3	23395		23398	
Tx	40	75	E 6.3	23408		23409	
Tx	10	100	E 6.3	23334		23338	
Tx	15	100	E 6.3	23352		23353	
Tx	20	100	E 6.3	23361		23362	
Tx	25	100	E 6.3	23374		23376	
Tx	27	100	E 6.3	23388		23390	
Tx	30	100	E 6.3	23399		23400	
Tx	40	100	E 6.3	23410		23411	
Tx	10	150	E 6.3	23339		23340	
Tx	15	150	E 6.3	23355		23357	
Tx	20	150	E 6.3	23364		23365	
Tx	25	150	E 6.3	23382		23383	
Tx	27	150	E 6.3	23392		23393	
Tx	30	150	E 6.3	23404		23405	
Tx	40	150	E 6.3	23414		23417	



SET PUNTAS DE PRECISI3N Precision Screw Bit Set Set embouts vissage de pr3cision



6 Sets

Nº Art.	€
21335	

58
pcs

Set 58 Pcs

Nº Art.	€
21334	



48 Puntas / Bits / Embouts material S2

PH	1.0 - 1.5 - 2.0 - 2.5 - 3.0 - 3.5
HEX	0.9 - 1.3 - 1.5 - 2.0 - 2.5 - 3.0 - 3.5 - 4.0 - 4.5 - 5.0 - 6.0
TS	2 - 3 - 4 - 5 - 6 - 7 - 8 - 9 - 10 - 15 - 20
SL	1.0 - 1.5 - 2.0 - 2.5 - 3.0 - 3.5
P	0.8 - 1.2 - 1.5 - 2.0
Y	0.8 - 2.0 - 2.5 - 3.0
	1.5
	SQ 0 - 1 - 2
	TA 2.0 - 2.3

6 Vasos / Sockets / Douilles hex. material CrV

M2.5 - M3.0 - M3.5 - M4.0 - M4.5 - M5.0

2 Adaptadores / Adaptors / Adaptateurs

H4.0 → H6.3 H6.3 → H4.0

- Destornillador Profesional Aleaci3n de Aluminio**
1 Professional Aluminum Alloy Screwdriver
Tournevis en alliage aluminium
- Alargador Flexible**
1 Flexible Extension Bar
Rallonge Souple

PUNTAS DE GRADO INDUSTRIAL

- Acero S2 de gran dureza (60 HRC)
- Cuellos largos para un mejor acceso
- Magn3ticos

INDUSTRIAL GRADE SCREW BITS

- Shock-resisting S2 Steel (60 HRC)
- Long neck. Suitable for hard-to-reach areas
- Magnetic

EMBOUTS 3 DEGR3 INDUSTRIEL

- Acier S2 de grande duret3 (60 HRC)
- Cous longs pour un meilleur acc3s
- Magn3tiques

Ref. **1527**

TOPE PROFUNDIDAD PLADUR

Plasterboard Depth Stop
But3e profondeur Plac3pl4tre



Tipo Type	D mm	L mm	DIN		Nº Art.	€ pack
PH	2	25	C 6.3	2	77339	
PH	2	50	E 6.3	2	74858	
PZ	2	25	C 6.3	2	81588	
PZ	2	50	E 6.3	2	81589	



Set 4 Pcs

Cont.	Nº Art.	€
PH2 - L25 PH2 - L50 PZ2 - L25 PZ2 - L50	81594	

Ref. **1529**

ADAPTADORES PUNTAS ATORNILLAR

Screwdriver Bit Adaptors
Adaptateurs embouts vissage



Tipo Type	L mm	d mm		Nº Art.	€ pack
Quick Lock INOX / Stainless	60	6,35	1	82687	



Tipo Type	L mm	d mm		Nº Art.	€ pack
Quick Lock	60	6,35	1	33746	



Tipo Type	L mm	d mm		Nº Art.	€ pack
SDS plus	78	6,35	1	33745	



Tipo Type	L mm	d mm		Nº Art.	€ pack
Magnético IND	60	6,35	1	33747	

Adaptador Magnético para Tornillos
Magnetic Screw Adaptor
Adaptateur magnetique pour vis



Tipo Type	mm	L mm	d mm		Nº Art.	€
Adapt.	6	65	6,35	1	42466	
Adapt.	7	65	6,35	1	42472	
Adapt.	8	65	6,35	1	42475	
Adapt.	10	65	6,35	1	42478	
Adapt.	12	65	6,35	1	42481	
Adapt.	13	65	6,35	1	42483	

* Interno / Internal / Intérieur

New!

Adaptador de 1/4 a 1/2
1/4 to 1/2 Adaptor
Adaptateur de 1/4 à 1/2

Para uso de herramientas de mango E6.3(1/4)
en llaves de impacto 1/2

It allows the use of E6.3(1/4) shank tools on a 1/2 Impact wrench

Pour utiliser des outils à queue hexagonale E6.3(1/4)
avec clés à choc de 1/2



mm	L mm	d mm		Nº Art.	€ pack
12,7	50	6,35	1	75107	



Set **1529**

Adaptador Magnético para Tornillos
Magnetic Screw Adaptor
Adaptateur magnetique pour vis

5 Pcs

D mm	L mm	d mm		Nº Art.	€
6-7-8-10-13	65	6,35	5	69751	



Ref. **3407**

EXTRACTORES IMPACTO

Impact Extractor
Extracteurs impact

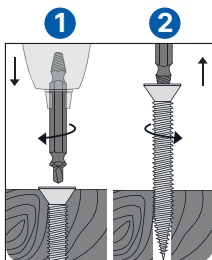

- 1. Taladrar el tornillo
- 2. Dar la vuelta y extraer

- 1. Drill the screw
- 2. Turn over and remove

- 1. Percer la vis
- 2. Retourner et retirez

Mod.	Cap. (mm)	Nº Art.	€
Nº 1	3-5	14953	
Nº 2	4-8	14955	
Nº 3	5-10	14956	
* Nº 4	6-12	14958	

- * Nº4 no es válido para atornillador de impacto
- * Nº4 is not suitable for impact drivers
- * Nº4 n'est pas valide pour les visseuses impact



Set 17 Pcs

Nº Art.	€
72898	



17
pcs

Extractores Impacto
Impact Extractors
Extracteurs impact
N.º 1 - 2 - 3 - 4

PH d mm: 6,35
PH1
PH2
PH3
L mm: 25

PZ d mm: 6,35
PZ1
PZ2
PZ3
L mm: 25

d mm: 6,35
Tx
T10
T15
T20
T25
T30
T40
L mm: 25

Adapt. Quick-Lock
L mm: 60 - d mm: 6,35

Box-Pallet - Ref. 3407



6 Sets

Nº Art.	€
74792	



Ref. **1461**

SET BROCAS Y PUNTAS ATORNILLAR







Drill Bit & Screwdriver Bit Set
Jeu de forets et embouts vissage



72
pcs

Brocas Metal Metal Drill Bits Forets Métal 2 - 3 - 4 - 5 - 6 - 8 mm	Brocas Pared Masonry Drill Bits Forets Maçonnerie 4 - 5 - 6 - 8 mm	Brocas Madera Wood Drill Bits Forets Bois 3 - 4 - 5 - 6 - 8 mm
Adapt. Magnético Magnetic Adapt. Adapt. Magnétique 6 - 7 - 8 10 - 13 mm	Adapt. Quick-Lock INOX/Stainless L mm: 60 - d mm: 6,35 1 pc.	Cuter Hoja Partible Snap-Off Box Cutter Cou-teaux à lames rétractables 1 pc.

Puntas Atornillar / Screwdriver Bits / Embouts Vissage

 PH d mm: 6,35 3x PH1 4x PH2 3x PH3 ←25 mm→	 Tx d mm: 6,35 T5 - T6 2x T10 T15 3x T20 4x T25 T27 3x T30 2x T40 ←25 mm→	 SL d mm: 6,35 SL 4 SL 4,5 SL 5,5 SL 6 SL 6,5 ←25 mm→
 PZ d mm: 6,35 3x PZ1 4x PZ2 2x PZ3 ←25 mm→	 SQ d mm: 6,35 SQ 1 SQ 2 SQ 3 ←25 mm→	 HEX d mm: 6,35 H2 H3 H4 H5 H6 ←25 mm→

N° Art. €
78504



PRESENTACIONES

Presentations

Presentations

PRESENTACIÓN IZAR EN LÍNEA

IZAR Line Presentation
Presentation IZAR ligne

430

PRESENTACIÓN IZAR EN CASCADA

IZAR Cascade Presentation
Presentation IZAR cascade

436

EXPOSITORES APILABLES

Stacking Exhibitors
Présentoirs apilables

440



¡NUEVA IMPLANTACIÓN LÍNEA!

New Line Stock Offer!

Nouveau implantation ligne!

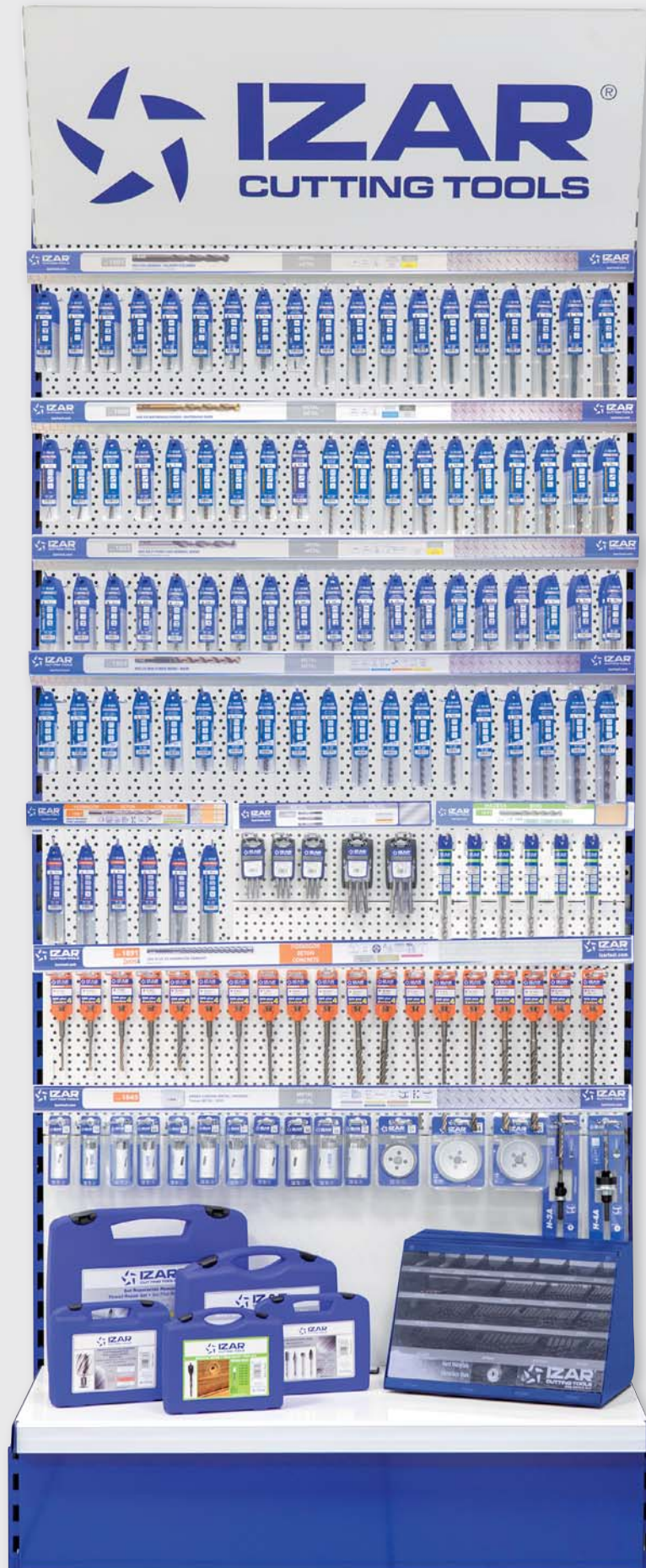

¡NUEVA IMPLANTACIÓN LÍNEA!

New Line Stock Offer!

Nouveau implantation ligne!

1 m 1001	BROCA MANGO CILÍNDRICO HSS HSS Straight Shank Drill Bit Foret queue cylindrique HSS	Ref. 4995 - N° Art. 70942: €	>> Pag. 59
1 m 1006	BROCA MANGO CILÍNDRICO COBALTO Cobalt Straight Shank Drill Bit Foret queue cylindrique Cobalt	Ref. 4995 - N° Art. 70936: €	>> Pag. 32
1 m 1002	BROCA MANGO CILÍNDRICO HSS SPEED POINT Speed Point HSS Straight Shank Drill Bit Foret queue cylindrique HSS Speed Point	Ref. 4995 - N° Art. 70947: €	>> Pag. 70
1 m 1004	BROCA UNIVERSAL COBALTO MULTI INOX Multi-STAINLESS Cobalt Universal Drill Bit Foret universel Cobalt Multi INOX	Ref. 4995 - N° Art. 70933: €	>> Pag. 25
33cm 1821	BROCA PUNTA METAL DURO PARED PRO 4Z+ MANGO 3 PLANOS 3-Flat Shank 4Z+ Professional Concrete Carbide Tipped Drill Bit Foret pointe carbure béton professionnel 4Z+ queue 3 plans	Ref. 4995 - N° Art. 84075: €	>> Pag. 267
33cm 3003	JUEGO MACHOS MANO MÉTRICA Metric Hand Tap Set Jeu de tarauds à main métrique	Ref. 4995 - N° Art. 70990: €	>> Pag. 134
33cm 1641	BROCA PUNTA CENTRAR PRO PRO Drill Bit Foret auto-centreur PRO	Ref. 4995 - N° Art. 71044: €	>> Pag. 298
1 m 1891	BROCA-MARTILLO SDS PLUS 4Z 4Z Cutter SDS plus Rotary Hammer Drill Bit Foret percussion SDS plus 4Z	Ref. 4995 - N° Art. 71015: €	>> Pag. 239
1 m 1645	SIERRA CORONA METAL / MADERA METAL / WOOD Hole Saw Trépan MÉTAL / BOIS	Ref. 4995 - N° Art. 71040: €	>> Pag. 278

TOTAL: €

* Maletines y Cabinet no incluidos
Cases & Cabinet not included
Mallettes et Présentoir non inclus



ACCESORIOS LÍNEAS

Line Accessories
Accessoires ligne



Panel Inicial 1 m
Initial Panel
Panneau initial

N° Art.	€
71120	



Panel Adicional 1 m
Additional Panel
Panneau supplémentaire

N° Art.	€
71169	



ACCESORIOS LÍNEAS

Line Accessories
Accessoires ligne

Copete Liso 1 m
Straight Top
Panneau supérieur lisse



N° Art.	€
59996	

Copete Curvo 1 m
Curve Top
Panneau supérieur courbe



Mod.	N° Art.	€
Standard	71112	
Standard + Led	71113	



Cajonera zócalo 100×40
Drawer
Tiroir

N° Art.	€
71111	



Balda
Shelf
Étagère

Mod.	N° Art.	€
100×30 cm	64056	
100×40 cm	64057	



Balda-Cesta 30×30
Basket-Shelf
Étagère-Panier

N° Art.	€
71124	



Balda-Podium 30×30
Podium-Shelf
Étagère-Podium

N° Art.	€
71110	

ACCESORIOS LÍNEAS

Line Accessories
Accessoires ligne

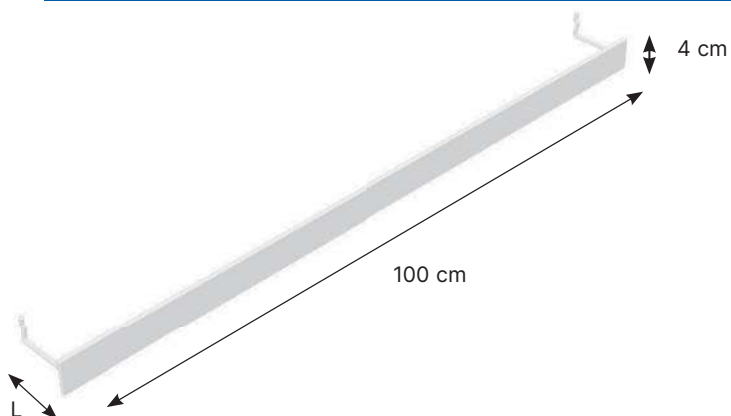

Porta-Cartel 1 m
Poster-Holder
Porte-Affiche

L cm	N° Art.	€
7,5	69760	
15	12696	
30	24448	

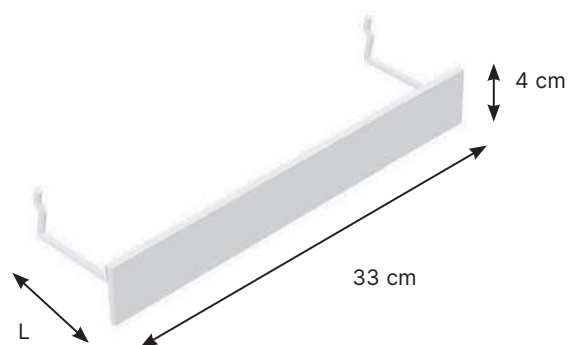

Porta-Cartel 33cm
Poster-Holder
Porte-Affiche

L cm	N° Art.	€
7,5	69781	
15	12686	
30	24449	

Gancho simple
Simple Hook
Crochet simple



Mod.	N° Art.	€
4x100 mm	52956	
4x150 mm	57810	
5x200 mm	22981	
6x300 mm	78834	

New!



Mod.	N° Art.	€
5x250 mm	75633	

Gancho doble
Double Hook
Crochet double



Mod.	N° Art.	€
4x150 mm	52957	

New!



Mod.	N° Art.	€
5x250 mm	78512	

Porta-precios
Price Holder
Porte prix



N° Art.	€
24261	



ACCESORIOS LÍNEAS

Line Accessories
Accessoires ligne

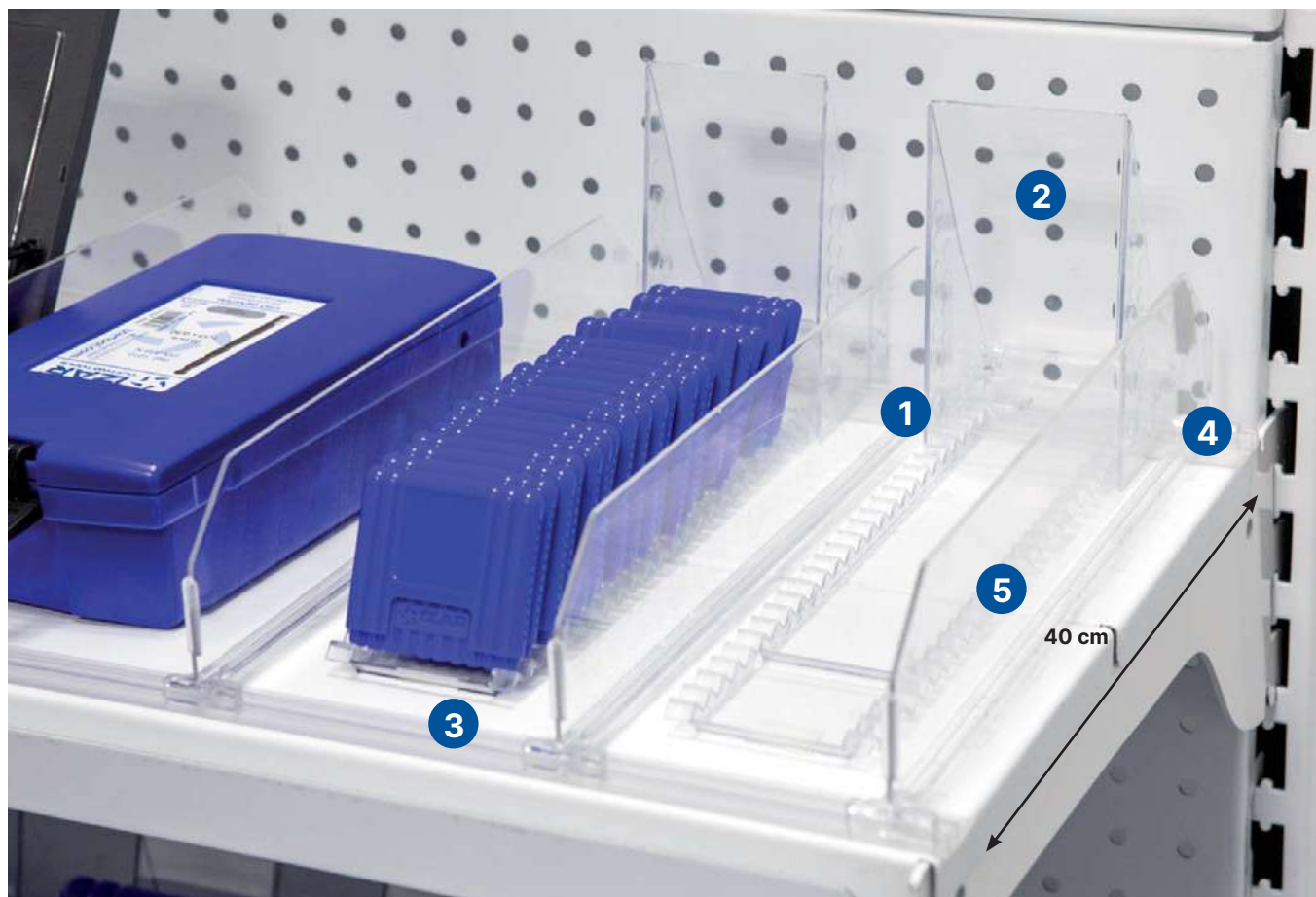

1 Rail
Rail / Raille

N° Art.	€
72270	

3 Tope frontal / Front block
Support adhesif frontal

N° Art.	€
71107	

5 Divisor balda
Shelf divider / Diviseur étagère

N° Art.	€
71106	

2 Empujador
Pusher / Pousser

N° Art.	€
71109	

4 Tope trasero / Back block
Support adhérière

N° Art.	€
71108	

6 Cartón Fin Gancho
Hook End Carton / Carton fin crochet



	N° Art.	€
Plastic Pouch	71118	
Doble Blister	71119	



IMPLANTACIÓN DISPLAY 2 METROS

2 Metre Display Stock Offer

Offre implantation presentoir 2 metres

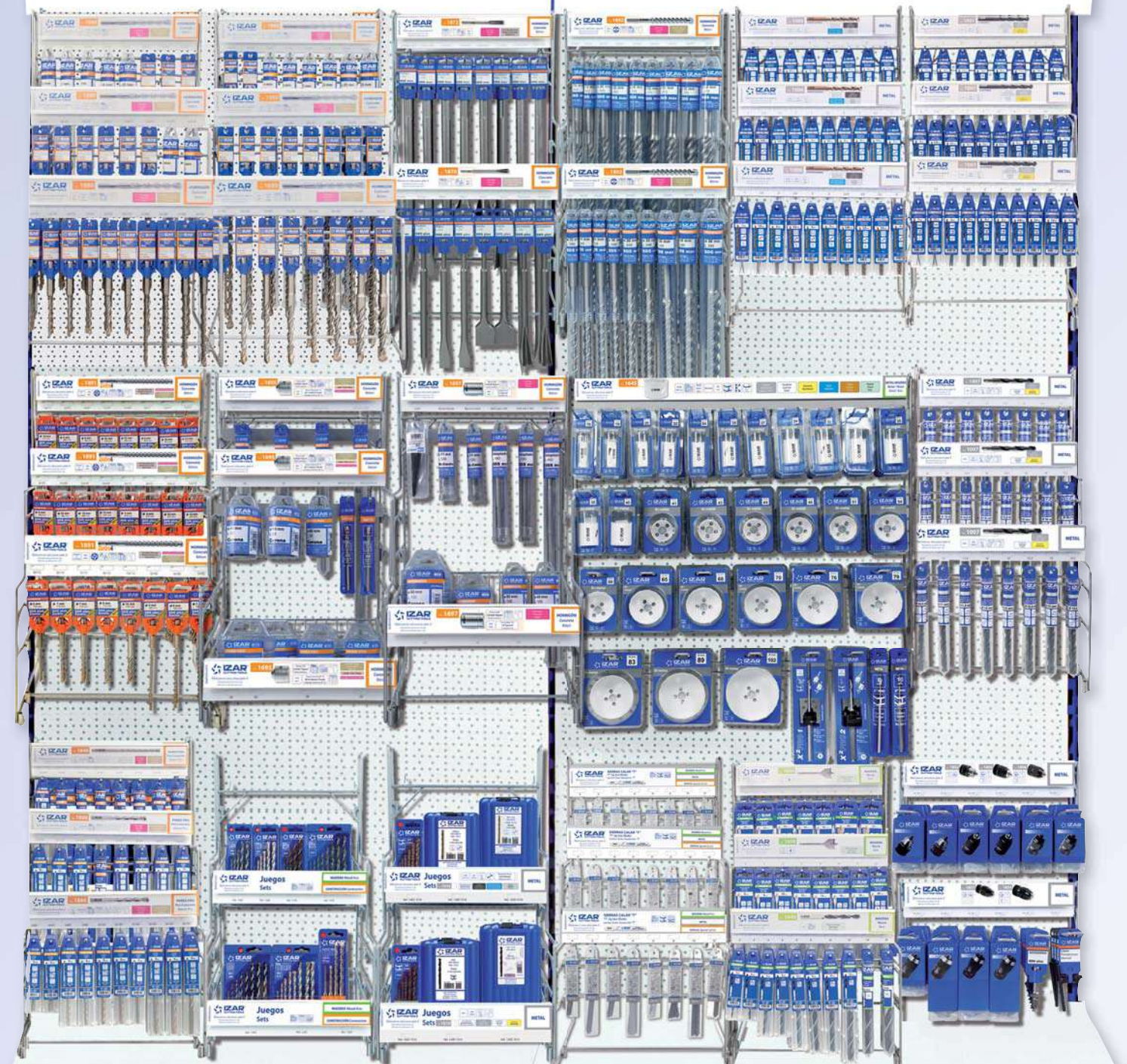

IMPLANTACIÓN DISPLAY 2 METROS

2 Metre Display Stock Offer

Offre implantation presentoir 2 metres

Display 01	BROCA-MARTILLO SDS PLUS 1 SDS plus Rotary Hammer Drill Bit 1 Foret percussion SDS plus 1	Ref. 4995 - N° Art. 22182: € >> Pag. 243
Display 02	BROCA-MARTILLO SDS PLUS 2 SDS plus Rotary Hammer Drill Bit 2 Foret percussion SDS plus 2	Ref. 4995 - N° Art. 22183: € >> Pag. 243
Display 03	BROCA-MARTILLO SDS MAX 4 PUNTAS 4-Cutter SDS max Rotary Hammer Drill Bit Foret percussion SDS max 4 pointes	Ref. 4995 - N° Art. 22315: € >> Pag. 249
Display 04	CINCELES SDS MAX / PLUS SDS max / plus Chisels Burins SDS max / plus	Ref. 4995 - N° Art. 22289: € >> Pag. 257
Display 05	CORONA LIGERA PARED PROFESIONAL Professional Concrete Light Hollow Core Bit Trépan béton professionnel	Ref. 4995 - N° Art. 22418: € >> Pag. 247
Display 06	CORONA PERFORADORA TALADRO PERCUTOR HORMIGÓN Tapered Hollow Hammer Core Bit Trépan pour perceuses percussion lourds béton	Ref. 4995 - N° Art. 22463: € >> Pag. 251
Display 07	BROCA PUNTA METAL DURO PARED PROFESIONAL Professional Concrete Carbide Tipped Drill Bit Foret pointe carbure béton professionnel	Ref. 4995 - N° Art. 22191: € >> Pag. 270
Display 10	BROCAS MADERA PALA Y 3 PUNTAS Wood Drill Bits Flat & 3-Pointed Forets bois mèches plates & 3-pointes	Ref. 4995 - N° Art. 22184: € >> Pag. 301
Display 12	PORTA-BROCAS TALADROS PORTÁTILES Y ESTACIONARIOS Portable & Stationary Drilling Machine Drill-Chucks Mandrins perceuses portables & fixes	Ref. 4995 - N° Art. 22334: € >> Pag. 96
Display 13	BROCA MANGO CILÍNDRICO COBALTO Cobalt Straight Shank Drill Bit Foret queue cylindrique Cobalt	Ref. 4995 - N° Art. 22181: € >> Pag. 33
Display 14	BROCA MANGO CILÍNDRICO HSS HSS Straight Shank Drill Bit Foret queue cylindrique HSS	Ref. 4995 - N° Art. 22162: € >> Pag. 59
Display 18	BROCA MANGO REBAJADO HSS HSS Reduced Shank Drill Bit Foret queue réduit HSS	Ref. 4995 - N° Art. 22352: € >> Pag. 75
Display 19	SIERRA CORONA METAL / MADERA METAL / WOOD Hole Saw Trépan MÉTAL / BOIS	Ref. 4995 - N° Art. 22220: € >> Pag. 278
Display 20	SIERRAS CALAR INSERCIÓN "T" "T" Insertion Jig Saw Blades Lames scies insertion "T"	Ref. 4995 - N° Art. 22391: € >> Pag. 416
Display 23	JUEGOS CASSETTE MADERA Y CONSTRUCCIÓN Wood & Construction Cassette Sets Jeux cassette Bois & Construction	Ref. 4995 - N° Art. 22372: € >> Pag. 302
Display 24	SETS BROCAS MANGO CILINDRICO HSS + HSSE HSS + HSSE Straight Shank Drill Bit Sets Jeux forets queue cylindrique HSS + HSSE	Ref. 4995 - N° Art. 22320: € >> Pag. 33
Display 61	BROCA-MARTILLO SDS PLUS 4Z 4Z Cutter SDS plus Rotary Hammer Drill Bit Foret percussion SDS plus 4Z	Ref. 4995 - N° Art. 29487: € >> Pag. 240



TOTAL €



IMPLANTACIÓN DISPLAY 1 METRO

1 Metre Display Stock Offer

Offre implantation presentoir 1 metre



Display
01

BROCA-MARTILLO SDS PLUS 1
SDS plus Rotary Hammer Drill Bit 1
Foret percussion SDS plus 1

Ref. 4995 - N° Art. 22182: €

>> Pag. 243

Display
02

BROCA-MARTILLO SDS PLUS 2
SDS plus Rotary Hammer Drill Bit 2
Foret percussion SDS plus 2

Ref. 4995 - N° Art. 22183: €

>> Pag. 243

Display
07

BROCA PUNTA METAL DURO PARED PROFESIONAL
Professional Concrete Carbide Tipped Drill Bit
Foret pointe carbure béton professionnel

Ref. 4995 - N° Art. 22191: €

>> Pag. 270

Display
10

BROCAS MADERA PALA Y 3 PUNTAS
Wood Drill Bits Flat & 3-Pointed
Forets bois mèches plates & 3-pointes

Ref. 4995 - N° Art. 22184: €

>> Pag. 301

Display
13

BROCA MANGO CILÍNDRICO COBALTO
Cobalt Straight Shank Drill Bit
Foret queue cylindrique Cobalt

Ref. 4995 - N° Art. 22181: €

>> Pag. 33

Display
14

BROCA MANGO CILÍNDRICO HSS
HSS Straight Shank Drill Bit
Foret queue cylindrique HSS

Ref. 4995 - N° Art. 22162: €

>> Pag. 59

Display
19

SIERRA CORONA METAL / MADERA
METAL / WOOD Hole Saw
Trépan MÉTAL / BOIS

Ref. 4995 - N° Art. 22220: €

>> Pag. 278

Display
23

JUEGOS CASSETTE MADERA Y CONSTRUCCIÓN
Wood & Construction Cassette Sets
Jeux cassette Bois & Construction

Ref. 4995 - N° Art. 22372: €

>> Pag. 302

TOTAL €



ACCESORIOS DISPLAYS

Display Accessories
Accessoires presentoir

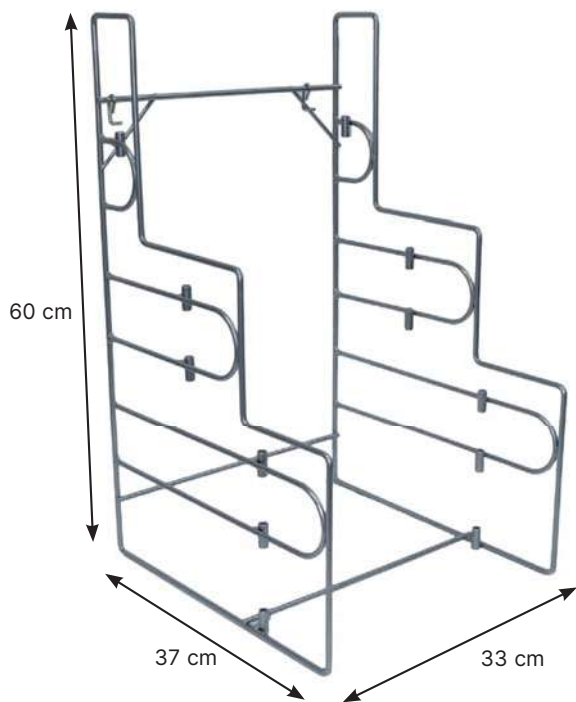

Display-Cascada
Cascade-Display
Display-Cascade

N° Art.	€
20182	

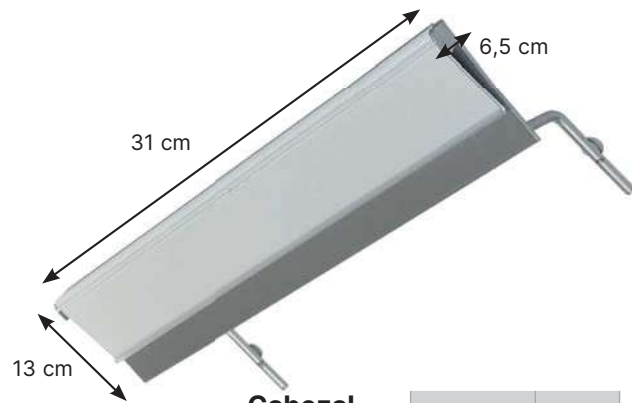

Cabezal
Header
Tête

N° Art.	€
22651	



Display-Línea
Line-Display
Display-Ligne

N° Art.	€
22650	



Gancho-08
Hook-08
Crochet-08

N° Art.	€
51837	

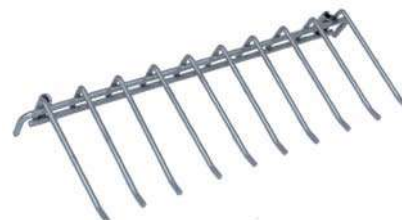

Gancho-10
Hook-10
Crochet-10

N° Art.	€
51840	



Gancho-06-Doble
Hook-06-Double
Crochet-06-Double

N° Art.	€
22653	

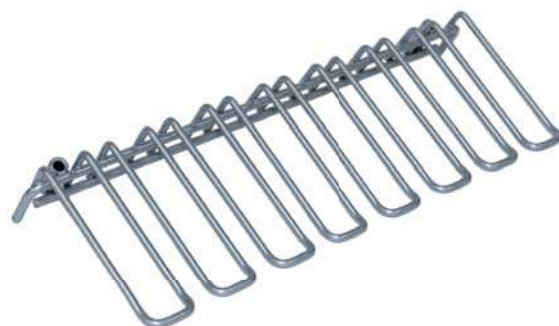

Gancho-08-Doble
Hook-08-Double
Crochet-08-Double

N° Art.	€
33241	

SISTEMA DE EXPOSITORES APILABLES

Stacking Exhibitors System

Système présentoirs empilables



Expo
1602 **1.**

EXPOSITOR BROCAS ESCALONADAS

Step Drill Display

Présentoirs forets étagés

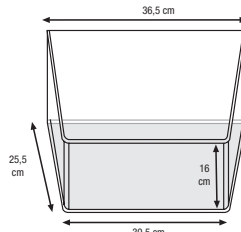

15 Pcs

N° Art.
65184

€

Cap. mm	N° Art.	Uds.
4-12	12048	2
4-20	12054	2
6-30	12060	2
9-36	12066	2
12-20	56798	2
20-30	56799	2
30-40	60715	1
40-50	60716	1
50-60	60717	1

Expo
9200 **2.**

EXPOSITOR FRESAS ROTATIVAS

Rotary Burr Display

Présentoirs fraises limes rotatives carbure

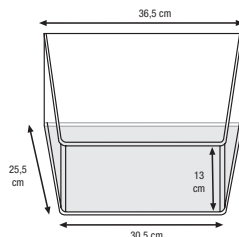

48 Pcs

N° Art.
57079

€

Ref.	Diam. mm	N° Art.	Uds.
9260	06,00X06,00	44141	2
	08,00X06,00	44142	2
	09,60X06,00	44143	2
	12,70X06,00	44144	2
9251	06,00X06,00	44438	2
	08,00X06,00	44439	2
	09,60X06,00	44440	2
	12,70X06,00	44441	2
9254	06,00X06,00	44488	2
	08,00X06,00	44494	2
	09,60X06,00	44500	2
	12,70X06,00	44512	2
9258	06,00X06,00	44721	2
	08,00X06,00	44722	2
	09,60X06,00	44723	2
	12,70X06,00	44724	2
9267	06,00X06,00	44792	2
	08,00X06,00	44793	2
	10,00X06,00	44794	2
	12,70X06,00	44795	2
9268	06,00X06,00	44808	2
	08,00X06,00	44809	2
	09,60X06,00	44811	2
	12,70X06,00	44814	2

Expo
1667 **3.**

EXPOSITOR CORONAS REAFILABLES HSS

HSS Resharpenable Hole Saw Exhibitor

Présentoir fraises à trépaner HSS

31 Pcs

N° Art.
66804

€

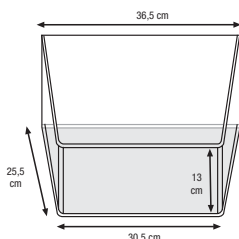

Diam.	N° Art.	Uds.	Diam.	N° Art.	Uds.	Diam.	N° Art.	Uds.	Diam.	N° Art.	Uds.
12	56569	1	20	56154	1	28	56587	1	39	56594	1
13	56570	1	21	56582	1	29	56588	1	40	56161	1
14	56572	1	22	56155	1	30	56158	1	42	56596	1
15	56573	1	23	56583	1	32	56159	1	45	56597	1
16	56152	1	24	56584	1	33	56590	1	48	56163	1
17	56576	1	25	56156	1	35	56160	1	50	56164	1
18	56578	1	26	56585	1	36	56591	1	65	56602	1
19	56579	1	27	56157	1	38	56593	1			



Matières premières de qualité supérieure

izartool.com/fr

Nuevo Portal de compras

New Shopping site

Nouveau site d'achat



Accede a todo el catálogo en un click
Encuentra fácilmente la herramienta que necesitas

Ahorra tiempo automatizando gestiones

Consulta stocks, accede y descarga facturas, pedidos, etc...

Access the entire catalogue in one click

Easily find the tool you need

Save time by automating procedures

Check stocks, access and download invoices, orders, etc...

Accédez à l'intégralité du catalogue en un click

Trouvez facilement l'outil dont vous avez besoin

Gagnez du temps en automatisant les procédures

Vérifiez le stocks, accédez et téléchargez les factures, commandes, etc...

CONDICIONES GENERALES VENTA

1. CONDICIONES DE PAGO

Giro a 30 días f.f. NETO.

2. VENCIMIENTOS FIJOS

En caso de fechas fijas de pago que rebasen los plazos estipulados giraremos a la fecha fijada pero inmediata anterior, según corresponda, siendo el plazo máximo en todo caso de 60 días, fecha factura o envío.

3. SEGURO

Las mercancías viajarán por exclusiva cuenta y riesgo del comprador, siendo siempre a cargo del mismo la prima del seguro que se realice, en los casos que el cliente desee asegurarla.

4. RECLAMACIONES

Se atenderán aquellas reclamaciones que se planteen dentro de los 8 días siguientes a la recepción del material no aceptando ninguna devolución sin el previo conocimiento de Fábrica.

5. DEVOLUCIONES

Sólo se aceptarán las devoluciones por defecto de fabricación o error atribuible a IZAR CUTTING TOOLS S.A.L. No se aceptarán devoluciones sin previa autorización de Fábrica o de nuestro delegado o representante. Las devoluciones serán a portes pagados e irán acompañadas de la factura original.

No se admitirán devoluciones procedentes de promociones ni en estuches defectuosos. Toda devolución originará una nota de cargo del 20% de su valor en concepto de manipulación e inspección de control de calidad.

6. CONDICIONALIDAD

La aceptación de las mercancías sin el rechazo inmediato por parte del comprador supone la aprobación de estas condiciones generales de venta y su modificación solamente tendrá validez si consta por escrito la conformidad de IZAR CUTTING TOOLS S.A.L.

7. I.V.A.

Los precios están sujetos al Impuesto sobre el Valor Añadido, siendo a cargo del cliente el recargo correspondiente.

8. GARANTÍAS

Todas las herramientas están garantizadas contra cualquier defecto de fabricación y materiales, sin responsabilizarse Fábrica de su utilización inadecuada. En todo caso, nuestra responsabilidad estará limitada al valor de la herramienta suministrada. Nos reservamos el derecho de modificar, sin previo aviso, las dimensiones, calidades del acero y, en general, todas las características técnicas de las herramientas. No será sustituida

ninguna herramienta sin el informe previo de nuestro Dpto. de Control de Calidad.

9. PORTES

Se suministrarán con franquicia de portes todos aquellos envíos cuyo valor neto de factura supere los 180 € netos por cada envío en territorio peninsular e Islas Baleares; 300 € en Canarias, Ceuta, Melilla y Andorra. En cualquier caso Fábrica se reserva el derecho de utilizar el medio de envío más económico. En las capitales donde Fábrica tenga establecidos depósitos de distribución, esta cláusula se aplicará para las reexpediciones a otras poblaciones de la provincia.

10. IMPORTE MÍNIMO POR PEDIDO

Queda establecido como pedido mínimo la cantidad de 60 € netos. Los pedidos inferiores se cobrarán al contado o por reembolso.

11. RESERVA DE DOMINIO

Nuestras ventas se consideran siempre bajo la condición de Reserva de dominio según el artículo 1.506 C.C. hasta que se haya hecho efectivo íntegramente el pago de todo lo adeudado.

12. JURISDICCIÓN COMPETENTE

Para cualquier discrepancia acerca de la interpretación de estas condiciones o litigio por razón de incumplimiento por cualquiera de las partes se someten ambas al fuero de los Juzgados y Tribunales de Bilbao, con renuncia al que pudiera corresponderles.

13. SISTEMA DE REDONDEO DEL EURO (2 DECIMALES)

La empresa aplica en sus sistemas informáticos la normativa legal vigente en esta materia.

14. NOTA IMPORTANTE SOBRE DISPLAYS MODULARES

Los Displays Modulares son propiedad de IZAR CUTTING TOOLS S.A.L. y la cesión sin costo para su uso a nuestros clientes se hace bajo las siguientes condiciones:

- Pedido inicial del Programa Completo.
- Uso único y exclusivo para los productos suministrados por IZAR CUTTING TOOLS S.A.L.
- Ejercicio de un mantenimiento razonable que evite daños al Display.

El sistema de Displays modulares está patentado por IZAR CUTTING TOOLS S.A.L. La infracción de dicha patente dará lugar a las acciones legales pertinentes.



General Sale Conditions

1. PAYMENT TERMS

Payment transfer within 30 days of invoice date. NET.

2. FIXED DUE DATE

In the case of fixed payment dates that exceed the stipulated deadlines we will use the fixed date, but immediately before, when appropriate, with the maximum period in any event being 60 days from the invoice or shipment date.

3. SAFETY

The goods will travel at the sole risk and expense of the buyer, who also is in charge of premium insurance, in cases where the customer wishes to insure them.

4. COMPLAINTS

Complaints made within 8 days of receipt of the material will be addressed, but no returns will be accepted without the prior knowledge of the Factory.

5. RETURNS

Returns will only be accepted if due to manufacturing defects or errors attributable to IZAR CUTTING TOOLS S.A.L. No returns will be accepted without prior authorisation from the Factory or our delegate or representative. Returns must be via prepaid freight and accompanied by the original invoice. We do not accept returns on promotional products or gift saw blade cases. All returns will incur a debit note of 20% of the product's value for handling purposes and Quality Control inspections.

6. CONDITIONS

Acceptance of the goods without immediate rejection by the buyer implies approval of these general conditions of sale, and any modifications to them shall only be valid if IZAR CUTTING TOOLS S.A.L. agrees in writing.

7. V.A.T.

The prices are subject to Value Added Tax (VAT), while the corresponding surcharge is the customer's responsibility.

8. WARRANTIES

All tools are guaranteed against any manufacturing and material defect, and IZAR cannot be held responsible for any improper use of the tools. In all cases, IZAR's liability is limited to the value of the supplied tool. We reserve the right to modify the dimensions, quality of steel and the

general technical characteristics of the tools without prior notice. No tool can be replaced without a prior report from our Quality Control Department.

9. SHIPPING

Shipments with carriage paid will be provided for all orders with a net invoice value exceeding €180 net per shipment in the mainland and the Balearic Islands; €300 in the Canary Islands, Ceuta, Melilla, and Andorra. In any case, IZAR reserves the right to use the most economical shipping method. In cities where IZAR has established distribution depots, this clause will apply to re-shipping to other towns in the province.

10. MINIMUM ORDER AMOUNT

The minimum order amount is €60 net. Orders priced lower than this will require cash on delivery or be refunded.

11. TITLE RESERVATION

Our sales are always considered to be subject to reserved property rights according to Article 1506 of the Spanish Civil Code until all due payments have been made in full.

12. COMPETENT JURISDICTION

To resolve any discrepancy regarding the interpretation of these conditions, or any litigation due to a breach by either party, both parties shall submit to the jurisdiction of the Courts and Tribunals of Bilbao, waiving any other jurisdiction to which they may otherwise be entitled.

13. EURO ROUNDING SYSTEM (2 DECIMALS)

The company applies the legal regulations in force regarding this matter in its IT systems.

14. IMPORTANT NOTE ABOUT MODULAR DISPLAYS

Modular Displays are the property of IZAR, and the free assignment for their use to our clients is made under the following conditions:

- Initial order of the Complete Program.
- Unique and exclusive use for products supplied by IZAR.
- Exercise of reasonable maintenance to prevent damage to the Display.

The modular Display system is patented by IZAR. Infringement of this patent will lead to the appropriate legal actions.

Conditions Générales de Vente

1. CONDITIONS DE PAIEMENT

Les paiements s'effectuent à 30 jours.

2. ECHEANCES

Quelle que soit la date fixée pour le paiement des factures, celui-ci doit être effectué au maximum 30 jours après l'envoi ou la date de facture.

3. ASSURANCE

Le risque lié à l'envoi des marchandises est assumé exclusivement par l'acheteur, toute latitude lui étant laissée s'il désire les assurer.

4. RECLAMATIONS

Seront prises en compte les réclamations portées à la connaissance de IZAR dans un délai de 8 jours suivant la réception des marchandises. Aucun retour ne sera accepté si cette condition préliminaire n'est pas satisfaite.

5. RETOURS

Seront acceptés les retours de marchandises pour défaut de fabrication ou erreur imputable à IZAR. Ne sera accepté aucun retour de marchandises sans accord préalable de notre part ou de notre représentant.

Les retours s'effectueront port payé et seront accompagnés de la facture originale. En aucun cas ne seront acceptés les retours de marchandises liées à des promotions ou en emballages défectueux. Les avoirs seront minorés de 20% de la valeur de la marchandise pour manipulation et inspection du contrôle de qualité.

6. CONDITIONNALITE

L'acceptation des marchandises de la part de l'acheteur implique l'acceptation de ces conditions générales de vente et leur modification ne sera valable qu'après approbation écrite de la part de IZAR.

7. T.V.A.

Les prix ne sont pas assujettis à la Taxe sur la Valeur Ajoutée.

8. GARANTIES

Tous les outils sont garantis contre les défauts de fabrication, IZAR ne pouvant en aucun cas être rendu responsable en cas d'utilisation inadéquate de ceux-ci. En tout état de cause, notre responsabilité se

limitera à la valeur de l'outil fourni. Nous nous réservons le droit de modifier, sans information préalable, les dimensions, qualités d'acier et en général toutes les caractéristiques techniques des outils. Aucun outil ne sera remplacé sans l'avis préalable de notre département de contrôle de qualité.

9. PORTS

Seront expédiées en franco de port en France Métropolitaine toutes les commandes dont le montant net dépasse les 300 €. IZAR se réserve le droit d'utiliser le moyen de transport le plus économique.

10. MONTANT MINIMUM DES COMMANDES

Le montant minimum des commandes est de 60 € nets.

11. RESERVE DE PROPRIETE

IZAR conserve tous les droits de propriété sur ses ventes jusqu'au paiement intégral des sommes dues.

12. JURIDICTION COMPETENTE

Tout litige relatif à l'interprétation de ces conditions ou au manquement de l'une des parties à ses obligations est de la compétence du Tribunal de Commerce de Bilbao.

13. ARRONDI DE L'EURO (2 DECIMALES)

L'entreprise utilise pour son système informatique la norme légale en vigueur sur ce sujet.

14. NOTE IMPORTANTE SUR LES PRESENTOIRS MODULAIRES

Les présentoirs modulaires sont propriété de IZAR CUTTING TOOLS S.A.L. et leur cession sans coût à nos clients pour leur utilisation se fait sous les conditions suivantes :

- Commande initiale du programme complet.
- Utilisation exclusive de produits fournis par IZAR CUTTING TOOLS S.A.L.
- Entretien raisonnable qui évite les dommages au présentoir













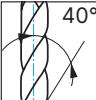











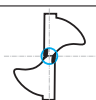
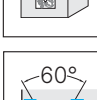







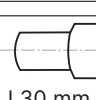
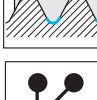







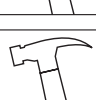
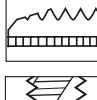

Le système de présentoirs modulaires est breveté par IZAR CUTTING TOOLS S.A.L. Le non-respect dudit brevet donnera lieu aux actions légales nécessaires.



ÍNDICE SÍMBOLOS

Symbol Index

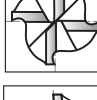
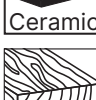
Index de symboles

	Ángulo Punta Point Angle Angle de pointe		Espesor Material Material Thickness Épaisseur matériel		Corte a Izquierda Left hand Cutting Coupe à gauche
	Ángulo de Hélice Helix Angle Angle d'hélice		Espesor Tubo Pipe Thickness Épaisseur tuyau		Magnético Magnetic Magnétique
	Afilado en Cruz Tipo DIN 1412 "C" Split Point DIN 1412 "C" type		Agujero Pasante Through Hole Trou débouchant		Cabezal Zentro4 Zentro4 head Tête Zentro4
	Affûtage en croix type DIN 1412 "C"		Agujero Ciego Blind Hole Trou borgne		Hormigón Reforzado Reinforced Concrete Béton armé
	Punta Centrar DIN 1412 E Center Point DIN 1412 E		Agujero Ciego Blind Hole Trou borgne		Hormigón Concrete Béton
	Pointe à Centrer DIN 1412 E		Rosca Standard Standard Thread Filetage standard		Hormigón Bloque Concrete Block Parpaing
	Mango 3 Planos 3-Flat Shank Attachement 3 plans		Rosca de tubo cilíndrica Straight Pipe Thread Filetage tubes cylindriques		Ladrillo Brick Brique
	Taladro Portátil Portable Drilling Machine Perceuse à main		Rosca Whitworth cilíndrica Straight Whitworth Thread Filetage Whitworth cylindrique		Cabezal 4 Puntas 4-Cutter Head Tête 4 pointes
	Mango Rebajado Reduced Shank Queue réduit		Plástico Plastic Plastique		Punta MD Afilada Carbide Split Point Affûtage pointe carbure
	Punta Metal Duro Carbide Tipped Pointe carbure		Ángulo Avellanado Countersinking- Counterboring Angle Angle de fraisage		Porcelánico Porcelain Porcelaine
	Afilado Universal Universal Point Affûtage universel		Ángulo Avellanado Countersinking- Counterboring Angle Angle de fraisage		Refrigeración Agua Water Cooling Refrigeration eau
	Sin Percusión No Percussion Sans percussion		Entrada Macho Tap Point Entrée de taraud		R.P.M. R.P.M. R.P.M.
	Percusión Percussion Percussion		Ángulo de Hélice Helix Angle Angle d'hélice		Herramienta Diamante Diamond Tool Outil diamant
	Ángulo Broca Escalonada Step Drill Angle Angle de foret etagé		Entrada GUN GUN Chamfer Entrée GUN		Amoladora Disc Grinder Meuleuse
	Conicidad Taper Conicité		Corte al Centro Center Cutting Coupe au centre		Cerámica Ceramics Céramique
	Puntos Soldadura Welding Point Points soudure		Sin Corte al Centro Non Center Cutting Sans coupe au centre		Madera Wood Bois
					Vidrio Glass Verre



ÍNDICE SÍMBOLOS

Symbol Index

Index de symboles



Metal
Metal
Métal

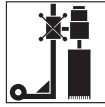

Máquina Perforadora
Core Drilling Machine
Carotteuse électrique



Inserción Rápida 1/4
Quick Shank 1/4
Attache rapide 1/4



Bujía
Spark Plug
Bougie



Abrasivos
Abrasives
Abrasisifs



Pulido
Sanding
Poncer

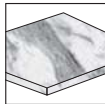

Mármol
Marble
Marbre



Perfil Parabólico "S"
S Parabolic Profile
Profil parabolique S



Madera Blanda
Soft Wood
Bois tendre



Madera Dura
Hard Wood
Bois dur



Contrachapado
Plywood
Contreplaqué

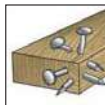

Madera+Clavos
Wood+Nails
Bois+Clous

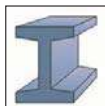

Metal
Metal
Métal

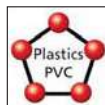

Plástico
Plastics
Plastique



Cristal
Glass
Verre



Mango Impacto
Impact Shank
Queue Impact

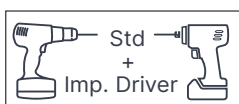

Válido Atornillador Impacto + Taladro normal
Suitable for Impact Driver + Standard Drill
Valide pour Visseuse Impact + Perceuse standard



Válido Mango Multi-Función
Multi-Tool
Multifonction



Fibra Vidrio
Fibreglass
Fibre verre

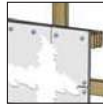

Pladur
Drywall
Plâtre



No ferrosos
Non-ferrous
Non ferreux



Perfiles
Profiles
Profils



Parquet-Laminados
Laminated-Parquet
Parquet-laminés

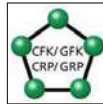

GFK



Cerámica
Ceramics
Céramique

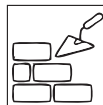

Grout-Mortero
Grout-Mortar
Coulées-Mortier

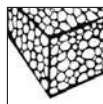

Aislamiento
Isolating
Isolant

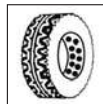

Caucho
Rubber
Caoutchouc

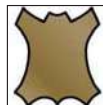

Cuero
Leather
Cuir



Restos blandos (pegamento, moqueta, silicona...)

Soft remains (glue, carpet, silicone...)
Restes tendres (colle, moquette, silicone...)



Distancia entre Dientes
Distance among Teeth
Distance entre les dents

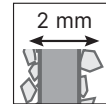

Espesor Dentado
Teeth Thickness
Épaisseur denture

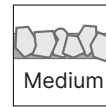

Tipo Dentado
Teeth Type
Type denture

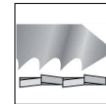

Dentado Alterno Basto
Rough Side Teeth
Denture avoyée gros

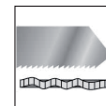

Dentado Ondulado Fino
Fine Wavy Teeth
Denture ondulé fin

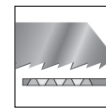

Dentado Rectificado Cónico
Conically Ground Teeth
Denture conique dépouillée

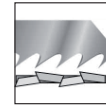

Dentado Alterno Diagonal
Diagonally Side Teeth
Denture avoyée diagonale



Punta Atornillar HEX
HEX Screwdriver Bit
Embout vissage HEX



Punta Atornillar PH
PH Screwdriver Bit
Embout vissage PH



Punta Atornillar PZ
PZ Screwdriver Bit
Embout vissage PZ



Punta Atornillar SL
SL Screwdriver Bit
Embout vissage SL



Punta Atornillar Tx
Tx Screwdriver Bit
Embout vissage Tx



Punta Atornillar Ts
Ts Screwdriver Bit
Embout vissage Ts



P. Atornillar SQUARE ROBERTSON
SQUARE ROBERTSON Screwdriver Bit
Embout vissage SQUARE ROBERTSON



Punta Atornillar TRIWING
TRIWING Screwdriver Bit
Embout vissage TRIWING



Punta Atornillar XZN
XZN Screwdriver Bit
Embout vissage XZN



Entrada Hexagonal
HEX Input
Entrée hexagonale



Búsqueda por referencia (Ref. - Página)

Search by reference (Ref. - Page)

Recherche par référence (Ref. - Page)

Ref.	Pag.	Ref.	Pag.	Ref.	Pag.	Ref.	Pag.	Ref.	Pag.	Ref.	Pag.	Ref.	Pag.
1001	58			1636	128	1804	93	1950	382	3404	176	8335	233
1002	69	1459	21-27-34-42-51-61-72	1637	88	1806	93	1960	390	3405	176	8341	233
1003	84			1639	313	1807	92	1994	217	3406	177	8342	235
1004	25	1460	275-303	1640	300	1809	95	1996	217	3407	356-427	8345	236
1005	40	1461	88-331-343-350-428	1641	298	1819	95	1997	217	3409	179	8350	232
1006	32			1642	284	1821	267	1999	217	3415	180	8351	230
1007	75			1643	311	1834	342					8352	229-338
1009	87	1462	21-27-34-42-51-61-72-77	1644	310	1836	276	2010	129	3500	165		
1010	53			1645	277	1839	340			3502	172	8900	219
1012	76			1646	284	1846	269	2530	131	3506	173	8901	219
1013	65	1466	21-27-34-42-51-61-64-72-74-77	1647	280	1849	293	2572	132	3510	169	8904	220
1015	47			1650	306-348	1851	288	2575	130	3536	168	8910	220
1016	28			1651	304-346	1852	288			3546	172	8920	221
1020	37			1653	304-347	1853	290	2900	376	3560	171	8925	221
1021	22	1470	36-63-73	1654	345	1854	289	2910	365			8930	222
1022	20			1655	308	1855	290	2930	370	3610	334	8940	222
1025	77	1476	81	1659	126	1857	291	2940	361	3650	335	8950	223
1027	43	1482	259	1660	78	1858	289	2950	378			8960	223
1030	82	1485	275	1661	282	1860	286	2960	379	3900	175	8970	224
1032	19	1486	271	1662	283	1861	291			3912	174	8990	225
1040	86	1487	271	1663	126	1862	292	3001	143			8991	225
1050	81	1488	275	1664	124-128	1863	293	3003	134	4060	121	8992	226
1052	80	1489	241	1665	127	1864	292	3005	167	4061	122		
1065	50	1490	87	1667	124	1869	241	3006	167	4062	123		
1090	87	1491	87	1669	314	1870	255	3010	140	4067	120	9015	44
		1492	87	1670	316	1871	258	3012	150	4070	112	9016	178
		1494	246	1671	316	1872	256	3016	152	4071	113		
1101	97	1497	246	1672	317	1875	253	3020	138	4072	114	9100	46
1102	97	1499	87	1673	317	1876	264	3023	144	4073	117	9200	203
1103	98			1674	315	1877	263	3026	151	4074	117	9201	205
1104	98	1510	425	1676	315	1879	261	3030	133	4075	110/123	9230	194
1110	89	1520	418	1677	316	1880	272	3032	149	4076	116	9231	195
		1521	422	1678	315	1882	259	3036	136	4077	111	9237	198
1404	35-52-62-73	1523	352-423	1679	314	1883	262	3037	136	4078	110	9238	199
1405	35-52-62-64	1524	353-424	1681	317	1886	268	3039	146	4079	115	9240	193
1406	35-52-62-73	1527	355-425	1682	318	1890	242	3040	145			9247	201
1407	35-62-64	1529	354-426	1685	314	1891	238			4223	211	9248	202
1408	35-52-62-64	1601	343	1686	318	1892	248	3100	153	4228	214	9250	194
1409	35-62-64	1602	100	1689	323	1894	250	3103	163	4229	216	9251	195
1410	36-52-63-73	1603	105	1690	326	1899	246	3109	159			9252	196
1435	303	1604	107	1692	312			3113	158	4412	209	9254	196
1438	303	1605	107	1695	247	1910	407	3119	157	4414	209	9255	197
		1606	107	1696	247	1915	415	3123	164			9256	197
		1607	107	1697	251	1920	385	3150	155	7001	325	9257	198
		1609	106	1698	251	1930	412	3157	161	7002	324	9258	199
		1610	108	1699	276	1940	398	3181	175	7003	325	9260	193
		1611	331			1945	413	3184	175	7009	324	9266	200
		1612	102	1800	94			3191	174			9267	201
		1613	330	1802	92					8301	227	9268	202
1456	21-27-34-42-51-61-64-72-74	1614	336	1803	94			3200	154	8302	227	9289	44
		1615	320					3250	156	8303	227		
		1616	329							8304	227	9411	208
		1617	104					3300	187	8309	294	9419	208
		1620	321					3303	189	8310	228	9459	207
		1621	349					3305	188	8318	294		
		1622	333					3307	189	8319	295-296	9674	206
		1625	322					3310	190	8320	294-295		
		1635	337					3311	190	8321	234-235	9994	99
								3312	191	8325	233		
										8326	234		
										8330	233		
										8331	294-295-296		



Búsqueda por referencia (Display - Página)

Search by reference (Display - Page)

Recherche par référence (Display - Page)

Display	Pag.	Display	Pag.	Display	Pag.	Display	Pag.	Display	Pag.	Display	Pag.
D-01	243	D-15	85	D-29	245	D-43	167	D-55	299-305	D-68	240
D-02	243	D-16	41	D-30	245	D-44	135	D-56	305-347	D-69	263
D-03	249	D-17	70	D-31	241	D-45	244	D-57	305-347	D-70	260
D-04	257	D-18	75	D-32	241	D-46	59	D-58	299	D-71	420
D-05	247	D-19	278	D-33	249	D-47	71	D-59	71-274-302	D-72	265
D-06	251	D-20	416	D-34	249	D-48	33	D-60	281	D-73	20
D-07	270	D-21	416	D-35	257	D-49	41	D-61	240	D-74	329
D-08	273	D-22	135	D-36	257	D-50	26	D-62	26	D-75	330
D-09	265-273	D-23	270-302	D-37	260	D-51	60-274-301	D-63	420	D-76	337
D-10	301-307	D-24	33-60	D-38	309	D-52	26-270-299	D-64	319	D-77	340
D-11	309	D-25	244	D-39	309	D-53	377	D-65	125	D-78	334
D-12	96	D-26	244	D-40	309	D-54	349	D-66	127	D-79	333
D-13	33	D-27	245	D-41	311			D-67	240	D-80	267
D-14	59	D-28	245	D-42	311						

Búsqueda por referencia (Línea - Página)

Search by reference (Line - Page)

Recherche par référence (Ligne - Page)

Línea	Pag.	Línea	Pag.	Línea	Pag.
L-1001-1 m	59	L-1625	322	L-2530	131
L-1002-1 m	70	L-1635	337	L-2572	132
L-1003-1 m	85	L-1639	313	L-2575	130
L-1004-1 m	25	L-1640-1 m	300	L-2900-1 m	377
L-1005-1 m	41	L-1641	298	L-3001	143
L-1006-1 m	32	L-1644-1 m	310	L-3003	134
L-1007-1 m	75	L-1645-1 m	278	L-3023	144
L-1010-1 m	56	L-1647-1 m	281	L-3109-1	160
L-1013-1 m	67	L-1650-1 m	307-348	L-3109-2	160
L-1015-1 m	49	L-1651-1 m	304-347	L-3119	157
L-1016-1 m	30	L-1654	345	L-3157-1	162
L-1020-1 m	38	L-1655-1 m	308	L-3157-2	162
L-1021-1 m	23	L-1667-1 m	125	L-3191	174
L-1027-1 m	43	L-16FM-1 m	319	L-3409	179
L-14S1	60-271-275-303	L-1821	267	L-3500	166
L-14S2	246-271-275	L-1834	342	L-3510	169
L-1601	343	L-1836	276	L-3536	168
L-1602	101	L-1839	340	L-3610	334
L-1603	105	L-1846-1 m	269	L-3650	335
L-1607	103	L-1870	257	L-3912	174
L-1609	106	L-1879	261	L-4060	121
L-1610	108	L-1880-1 m	272	L-4061	122
L-1611	331	L-1883-1 m	262	L-4062	123
L-1612	102	L-1886-1 m	268	L-4067	120
L-1614	336	L-1890-1 m	243	L-4070	112
L-1615	320	L-1891-1 m	239	L-4071	113
L-1617	104	L-1892-1 m	248	L-4072	114
L-1620	321	L-18PB	96	L-4076	116
L-1621	349	L-18PB-1 m	96	L-4077	111
L-1622	333	L-19C1-1 m	416	L-4078	110
		L-19C2-1 m	416	L-4079	115
		L-19SS-1 m	395	L-9200	204





IZAR CUTTING TOOLS, S.A.L.

C.I.F.: A-48932826

Parque Empresarial Boroa 2B2

48340 AMOREBIETA (Bizkaia)

Spain

izartool.com

COMERCIAL NACIONAL ✉ comercial@izartool.com

**PEDIDOS Y
ATENCIÓN A CLIENTES** ☎ 94 630 02 41

SERVICIO TÉCNICO ☎ 94 630 02 43

EXPORT SALES ✉ export@izartool.com

**ORDERS & CUSTOMER
ASSISTANCE** ☎ +34 94 630 02 46

VENTES FRANCE ✉ france@izartool.com
☎ +34 94 630 02 45

VENDITA ITALIA ✉ italia@izartool.com
☎ +34 94 630 02 45



izartool.com



Todas nuestras publicaciones se imprimen en papel ecológico procedente de fuentes responsables con el medioambiente y la sociedad.

All our publications are printed on ecological paper from environmentally and socially responsible sources.

Toutes nos publications sont imprimées sur du papier écologique issu de sources écologiquement et socialement responsables.